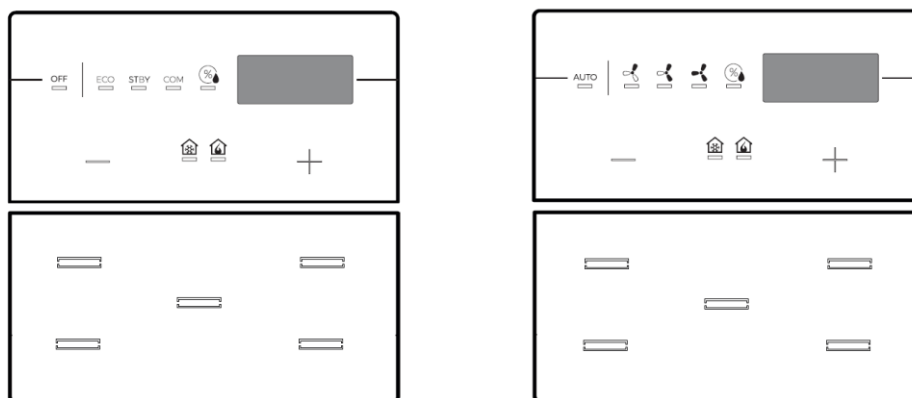

9025 CAPACITIVE RANGE
RT07A01KNX Capacitive Thermostat
RH07A01KNX Capacitive Thermostat / Humidistat
Product Handbook

9025
 CAPACITIVE THERMOSTAT

Product:

RT07A01KNX
 RH07A01KNX

Description:

9025 capacitive thermostat / humidistat

Document

Version: **1.2**

Date:

01/02/2018

INDEX

1.	General Introduction	4
2.	Product overview	4
3.	Installation instructions	5
4.	General Parameters.....	7
	Display and led's settings	7
	General settings.....	8
	Special buttons.....	8
	Front Panel.....	9
5.	Button <x> configuration.....	9
	Activation on press.....	10
	Activation on press / release.....	10
	Activation on short and long press.....	11
	Dimming	11
	Shutter and Blinds.....	11
	Scene	11
	Commands sequences	12
	Set RGB color.....	12
	MUR / DND.....	13
	Loop among values.....	13
6.	Led.....	13
7.	RGB Led	13
	RGB General.....	14
	RGB Function	14
8.	Temperature.....	15
9.	Temperature Probes.....	15
10.	Temperature Sensor Function	16
11.	Thermostat Function.....	17
	Target Setpoint Settings.....	17
	Two points on/off.....	19
	Integral proportional control PWM.....	20
	Integral proportional contr. continuous.....	21
	Fan coil on/off.....	21
	Fan coil control %.....	22
	Additional valve	22
	Force fan coil speed.....	23
	Ventilation mode.....	23
	Temperature probe failure / out of range measurement.....	23
	<General> ALARM object.....	23
12.	Thermostat behaviour on bus failure, recovery and download.....	24
	Behaviour on bus voltage failure.....	24
	Behaviour on bus voltage recovery.....	24
	Behaviour ETS Download	24
13.	Control panel	25

14.	Input.....	25
15.	Humidistat.....	25
16.	Logics.....	26
17.	Virtual holder.....	27
	How it works.....	28
	Communication Objects.....	28
	Parameters – General.....	28
	Parameters – Remote inputs.....	29
	Remote Sensor Inputs (Global Enable).....	30
18.	Wrong application download.....	30

Any information inside this manual can be changed without advice.

This handbook can be download freely from the website: www.eelectron.com

Exclusion of liability:

Despite checking that the contents of this document match the hardware and software, deviations cannot be completely excluded. We therefore cannot accept any liability for this.

Any necessary corrections will be incorporated into newer versions of this manual.

Symbol for relevant information



Symbol for warning



1. General Introduction

This manual is intended to be used by installers and describes functions and parameters of the 9025 capacitive thermostat and thermostat / humidistat and how is possible to change settings and configurations using ETS software tool.

2. Product overview

9025 capacitive thermostat / humidistat is designed to be installed in Home and Building installations (i.e. offices, hotels, private houses, etc...).

9025 RT07A01KNX and RH07A01KNX are KNX® room temperature controller that includes 7 configurable capacitive buttons for on / off, dimming, rolling shutters and venetian controls, scene recall and control, object sequences, local thermostat controls, etc.

Device offers a 2 stage thermostat with integrated PI controller to control heating and cooling equipments, valves, 2 and 4 pipes fan coils etc ..

Device has an embedded temperature sensor and a rear 2 poles connector, configurable as digital or analog input; It's possible to connect an additional NTC temperature probe (eelectron codes TS01A01ACC or TS01B01ACC - not included) to perform a direct temperature measurement.

A version with integrated temperature and relative humidity sensor (RH07A01KNX) is available usable for controlling actuators for ambient humidity control.

Device has a RGB led bar on the front side in order to visualize thermostat operating modes or feedbacks and other values available over the KNX bus.

Glass covers are available for HOTEL or RESIDENTIAL applications; both covers can be in

CUSTOM version. Using glasses in CUSTOM version is possible to light up custom and interchangeable icons matching with the associated function.

The 9025 KNX® range is mounted in 2 module box and is compliant with main standards (British, German, Italian, etc).

Capacitive and Proximity features:

Device has 7 capacitive switches with proximity function. If economy mode is enable device goes in eco mode (all the led's switched off) after a configurable time; it can be awakened if it detects the presence within a few centimetres.

RGB bar and display can be set to go in eco mode as well.



WARNING

If the cover is applied with the device switched on - than you have to wait about 2 minutes to let the device adapt to the presence of the cover; in the meantime it's possible that the button doesn't react to the finger press.

Probe:

For NTC temperature probe the following eelectron code accessories must be used:



TS01A01ACC (from -20°C to +100°C)

TS01B01ACC (from -50°C to +60°C)

Buttons main functions:

- 1 bit commands: load activation / deactivation commands (ON/OFF/TOGGLE) with short press or with differentiation of long and short press
- 1 byte commands (unsigned 0-255 or HVAC commands or value % commands).
- Sending of long action telegrams on the same address of short action or on a different group address
- Cyclic sending
- Sequences (3 commands mixing 1bit/1byte objects) with different group addresses - in short and long press mode or in toggle mode

- Dimmer management (with single or double push-button)
- Blind / Roller Shutter management (with single or double push-button)
- Command sequences with 1 bit to manage row of lights in on/off
- RGB color setting with fixed (short press) or changing color (long press); 1 byte or 3 bytes datapoint available
- MUR/DND (Make Up Room / Do Not Disturb) function with embedded logic
- Loop among values function in order to send step by step a sequence of 1 byte values

Rear input:

For digital inputs Max. length of Connecting Cable: ≤ **10 m** (twisted cable)

For analog input: Max. length of Connecting Cable: ≤ **20 m** (twisted cable)

Room temperature controller main functions:

Configured as Temperature sensor - main functions:

- 2 different temperature thresholds to trigger 1 bit telegrams alarm/warning
- Enable / disable of alarm / warnings via 1 bit object

Configured as Thermostat - main functions:

- Different control algorithms: 2 point on/off; PWM; Continuous Control / Fan Coil Control
- Different setting modes: via HVAC automatic / via HVAC Manual / via Setpoint
- 2nd stage additional command object
- Window contact function
- Additional external temperature sensors (optional)

Configured as Control Panel (intended to be used as a visualization panel or user interface of another device which is responsible of the temperature control, typically a Fan Coil Controller):

- Set and send setpoints, HVAC modes; Heat/Cool mode, etc.

- Set and send Fan Coil forced speeds.
- Visualization of internal temperature or external or a mix of them

RGB bar main functions:

- Temporary function for button press with fixed color
- Classic RGB: color can be changed by bus and switched on / off
- KNX feedback: Up to 5 1 bit obj feedback can be received and associated to different colors, last received is shown
- Physical dimension: different values (from 1 byte to 4 bytes) can be received from the bus and the RGB color can be set to change color on the base of the received value
- Demo color loop: sequence of color changing, warm colors, cold colors, all colors.
- Step light mode: 1 bit object can trigger the RGB led bar to switch ON in a fixed color with max priority.

Logic and Virtual Holder Function

Device includes some logic functions and a Virtual Holder embedded logic.

Logics – main functions

- 2 input object and 1 output obj for every logic
- Delay, retransmission of telegrams
- NOT / AND / OR / NAND / NOR / XOR / XNOR
- Bit to Byte conversion
- Byte to Bit conversion
- 1,2,4 Bytes Threshold
- Free expressions with 4 input objects and 1 out object

3. Installation instructions

The device may be used for permanent indoor installations in dry locations within wall box mounts.

WARNING

- Device must be installed keeping a minimum distance of 4 mm between electrical power

line (mains) and input cables or red / black bus cable .

- The device must not be connected to 230V cables
- The prevailing safety rules must be heeded.
- The device must be mounted and commissioned by an authorized installer.
- The applicable safety and accident prevention regulations must be observed.
- The device must not be opened. Any faulty devices should be returned to manufacturer.
- For planning and construction of electric installations, the relevant guidelines, regulations and standards of the respective country are to be considered.
- KNX bus allows you to remotely send commands to the system actuators. Always make sure that the execution of remote commands do not lead to hazardous situations, and that the user always has a warning about which commands can be activated remotely.
- Glass covers should be handled with care to prevent the glass from being damaged or broken

For further information please visit www.eelectron.com



DISPOSAL: The crossed-out bin symbol on the equipment or packaging means the product must not be included with other general waste at the end of its working life. The user must take the warn product to a sorted waste center, or return it to the retailer when purchasing a new one. An efficient sorted waste collection for the environmentally friendly disposal of the used device, or its subsequent recycling, helps avoid the potential negative effects on the environment and people's health, and encourages the re-use and/or recycling of the construction materials.

Wall mounting sequence

1 Fix the metal frame on the wall box using the included screws.

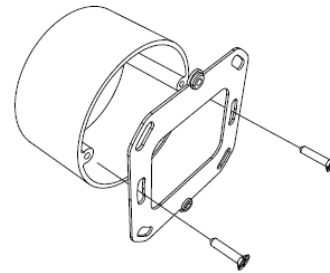

2 Connect KNX cable to the device and fix it to the metal frame using the included screws.

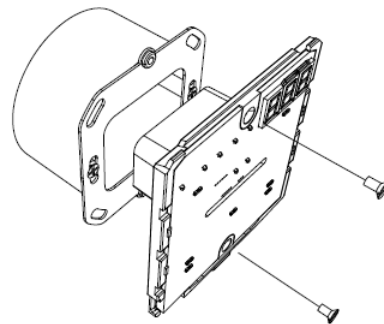

3 Apply the glass cover by attaching the top and then pushing the bottom, you must hear the click! to indicate the correct engagement

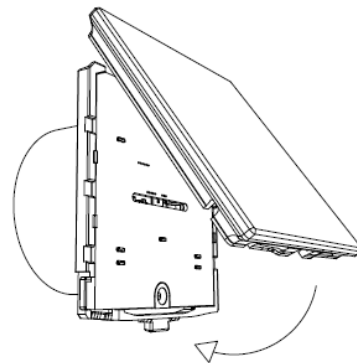

4 To release the glass cover, push the pivoting pin on the bottom of the plastic cover, then release the lower part first and then the top.

4. General Parameters

Display and led's settings

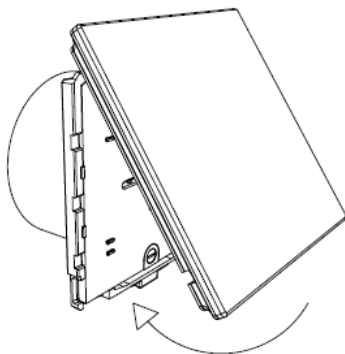

Physical dimensions

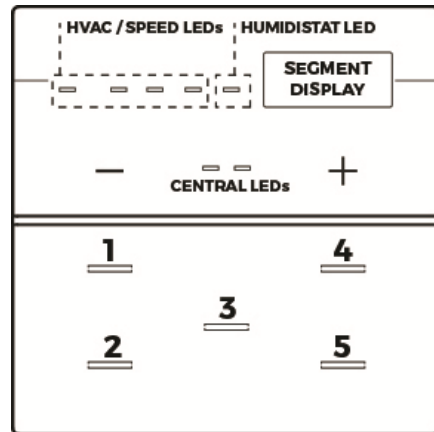
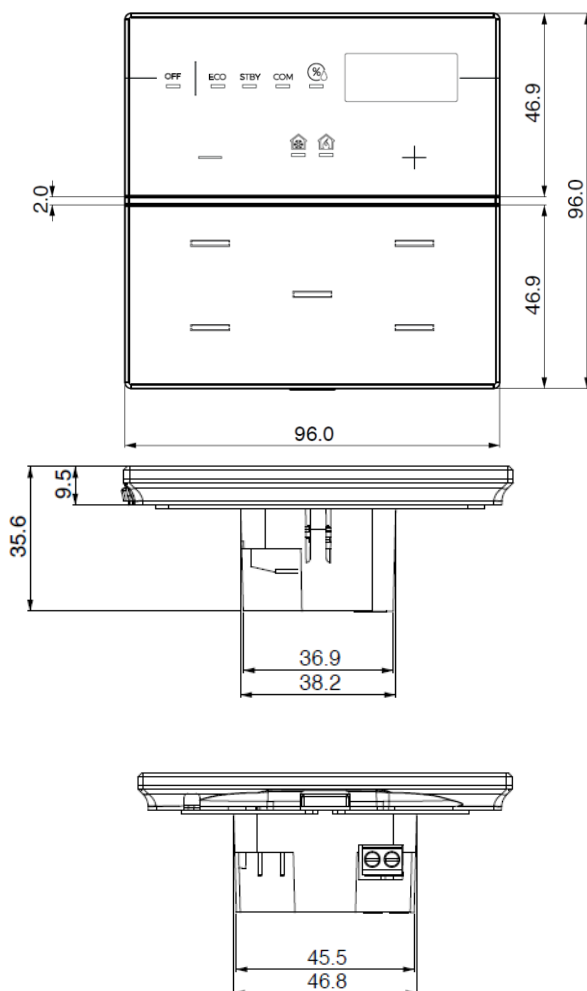

KNX PARAMETER	SETTINGS
Segment display used for:	nothing temperature humidity relative setpoint absolute setpoint
nothing:	display not used
temperature:	display shows temperature ^[1]
humidity:	display shows humidity ^[2]
relative setpoint:	display shows setpoint shift ^[1]
absolute setpoint:	display shows setpoint ^[1]
[1] values are in °C [1] values are in % - only for RH07A01KNX	
Segment display periodically used for	nothing temperature humidity relative setpoint absolute setpoint
It's possible to configure the display to periodically show a second dimension besides the main visualization; in this case you can set a duration and a time period for periodic viewing	
HVAC/Speed leds used for	nothing hvac fancoil speed

4 led's on the up left side can be configured to show : HVAC: leds shows hvac status (OFF, ECONOMY, STANDBY, COMFORT) FANCOIL SPEED: leds shows fancoil speed status (speed 1,2,3 AUTO or OFF)	
Central LEDs used for	Nothing / heat-cool
Led ON means heat or cool mode active, led blinking means heat or cool controlled equipment switched ON	

General settings

KNX PARAMETER	SETTINGS
Delay on Power-up	5 ÷ 15 seconds
<p>Through this parameter is possible to set the delay of transmission of telegrams after a power on by selecting the time by which the device is allowed to send telegrams.</p> <p>In large systems after a power failure or shutdown this delay avoids to generate excessive traffic on the bus, causing slow performance or a transmission block.</p> <p>If there are different devices requiring sending telegrams on the bus after a reset, these delays must be programmed to prevent traffic congestion during the initialization phase.</p> <p>The input detection and the values of objects are updated at the end of the transmission delay time At the end of ETS programming the device behaves like after a power on.</p>	
Temperature function	temp. func. disabled temperature sensor thermostat control panel
<p><u>temp. func. disabled</u> no temperature function is active; device is only a switch</p> <p><u>temperature sensor</u> device can be used to measure the temperature with its internal or additional probe, mix it with values from the KNX bus, switch on and off other equipments using 1</p>	

bit obj (see: Temperature Sensor Function). <u>thermostat</u> by selecting this option a full thermostat is enable (see: Thermostat Function). <u>control panel</u> by selecting this option device can be used to manage the basic parameter of another thermostat or room controller (see: Control panel)	
Virtual holder	disabled / enabled
By setting this parameter, you can enable a "virtual holder", that is, a logical function that automatically recognizes the presence of a person in a room. This feature can be used in hotel or similar installations and requires connection to other devices (see Virtual holder)	
Enable cleaning object	disabled / enabled
Setting this parameter a 1-bit communication object is shown; when the device receives a value on that object (0 or 1 set by parameter), the capacitive function is disabled and the device does not react when the keys are pressed. The device returns to normal operating condition after configurable time or when it receives a telegram on this object with a bit value opposite to the previous one. This function is used to allow the cleaning of the device without causing accidental commands.	
Enable brightness obj.	disabled / enabled
Enabling this parameter is available a 1-byte communication object with which you can set the percentage of brightness of LEDs. By acting on this value, the brightness of LEDs is changed for either the ON or the OFF state.	
Enable alarm obj	disabled / enabled
Setting this parameter a 1-bit communication object is shown, it is used to report a malfunction related to the temperature sensor.	

Special buttons

The "Special buttons" page is only visible if "thermostat" or "control panel" is selected for the

"Temperature function" parameter on the "General settings" page. When a button is configured as a "special button" there are no communication objects associated with it; the button it is assigned to a function that changes the behavior of the thermostat, thermostat / humidistat or control panel.

Associated functions are:

fan coil speed	modifies the fan coil speeds
heat-cool	set regulation type in heating or cooling
HVAC	HVAC mode - comfort - standby - economy - build. prot.
setpoint	increase / decrease setpoint
thermostat on-off	affects on/off state of thermostat
HVAC Control	follows DPT_HVACContrMode (20.105)

Front Panel

KNX PARAMETER	SETTINGS
Brightness	100%, 75%, 50%, 25%
This parameters affects the brightness of frontal LEDs; by acting on this value, the brightness of LEDs is changed for either the ON or the OFF state. This value can be overwritten runtime by the object 46 : "<General> Brightness"	
 SEGMENT DISPLAY is not affected by the brightness setting.	
Sleep Mode (proximity)	disabled / enabled
When this option is enabled, the device enters economy mode after a configurable time with the "Standby time (sec)" parameter. When the device enters in sleep mode all the LEDs are switched off,	

the device is awakened by the proximity function simply by approaching the front panel. If you want one or more LEDs to stay on when the device goes into sleep mode, simply set the "Led <x> ON behavior in sleep mode" to the "stay on". The same can be done for the RGB bar if available (RGB range).

Button press release threshold	10 % to 100%
---------------------------------------	--------------

This parameter allows you to adjust the sensitivity of the capacitive keys, the higher the threshold the higher will be the sensitivity of the device. Setting the threshold to 100% will result in a very sensitive device while a 10% threshold will match the minimum sensitivity. Under normal environmental conditions leave the parameter to the default value (70%).

RGB behaviour in sleep mode	disabled / enabled
------------------------------------	--------------------

See parameter "Sleep Mode (proximity)"

Button <x> beep on press	disabled / enabled
---------------------------------------	--------------------

This parameter enable / disable the buzzer sound when button <x> is pressed.

5. Button <x> configuration

For each of the 7 buttons on the device, the selections are made through a configuration page.

Every single button can be configured to perform one of the following functions:

- Activation on press
- Activation on press / release
- Activation on short and long press
- Dimming
- Shutter and blinds
- Scene
- Command sequences (short and long press)
- Command sequences (toggle function)
- Command sequences 1 bit
- Set RGB color
- MUR/DND function
- Loop among values

KNX PARAMETER	SETTINGS
Function	Activation on press
	Activation on press / release
	Activation short and long press
	Dimming
	Shutter and blinds
	Scene
	Command sequences (short and long press)
	Command sequences (toggle function)
	Command sequences 1 bit
	Set RGB color
	MUR/DND function
	Loop among values
	See following paragraph:
<u>Activation on press</u>	
<u>Activation on press / release</u>	
<u>Activation on short and long press</u>	
<u>Dimming</u>	
<u>Shutter and Blinds</u>	
<u>Scene</u>	
<u>Commands sequences</u>	
<u>Set RGB color</u>	
<u>MUR / DND</u>	
<u>Loop among values</u>	

Configurations for 1 bit object:

On
Off
Toggle

Configurations for 1 byte object:

Value 0-255 (generic signed int)
Value 0-100% (scaling value in steps of 5%)
HVAC Mode (DPT_HVACMode 20.102)

KNX PARAMETER	SETTINGS
Cyclic sending when button pressed	Never
	0.3 sec.
	0.4 sec.
	0.5 sec.
	0.8 sec
	1.0 sec.
	1.2 sec.
	1.5 sec.
	2.0 sec.
	3.0 sec.
	5.0 sec.
8.0 sec.	
10 sec.	
As long as the button is pressed, the telegram with selected size and value is sent cyclically; this parameters defines the time interval between two sendings	

Activation on press

“Activation on press” allows you to configure the sending of telegrams when the button is pressed; device can also be configured to send periodic messages with repetition period.

KNX PARAMETER	SETTINGS
Telegram Associated	1 bit / 1 byte
It is possible to send 1 bit or 1 byte objects	

Activation on press / release

“Activation on press / release ” allows you to configure the sending of telegrams when the button is pressed and when it is released. Parameters are identical to the choice “activation on press”; one parameter is added:

KNX PARAMETER	SETTINGS
Communication object on release	disabled / enabled

if enabled, this parameter displays an additional communication object (<Button x> Release Action) that is transmitted on the release event, this object can be associated with a group address other than the one that sends the value associated with the pressure.

Activation on short and long press

The different duration between short and long press is defined by the parameter "Minimum time long press button".

You can set to send a telegrams with different values on short and long press or decide to send commands only on one of this events.

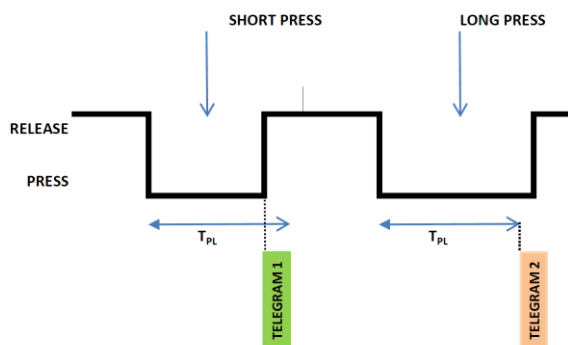

When button is pressed then counting time starts; if the button is released before time exceeds TPL time, device executes the command associated with the event of "short press" and if, on the contrary, TPL timeout expires and button is still pressed then the command associated with the event of "long press" is executed.

The parameters and mode of transmission of telegrams can be managed through "activation on long and short press" are the same set with the configuration "Activation of press / release " except for the function of cyclic sending that is not provided here.

Dimming

Through the dimming function it's possible to control a light dimmer using short and long press of the buttons.

Each button uses 2 communication objects:

- 1 bit dimension for ON /OFF command associated to short press operation
- 4 bit dimension for brightness regulation associated to long press operation

Parameter "Minimum time long press button" can set the minimum duration of long press; "Dimming mode" and "Dimming step" can define brighter or darker behaviour and step of each long press action.

Shutter and Blinds

Through the Shutter and Blind function it's possible to control Roller Shutters or Blinds using short and long press of the buttons.

Each input uses 2 communication objects:

- 1 bit dimension for STEP /STOP command associated to short press operation
- 1 bit dimension for UP / DOWN command associated to long press operation

Parameter "Minimum time long press button" can set the minimum duration of long press; "Command drive shutter" can define up or down behaviour associated to long press action.

Scene

In this configuration page it's possible to set the button for scene management: learn and recall scene commands.

These different behaviour (recall and learn) are performed through two different actions (short and long press) of the button.

Learn scene on long press action is enabled by a parameter; "Minimum time long press button" can set the minimum duration of long press.

KNX PARAMETER	SETTINGS
Scene Number	Number of the scene: 0 ÷ 63
This parameter sets the value of the scene you intend to learn / recall (one per channel). Remember that output devices (i.e. actuators, etc.) generally can manage several scenes, each identified by a value (that varies from 0 to 63); therefore is important to set this parameter correctly and matching the number set on the actuators.	
Store scene on long press	disabled / enabled
If disable, long press action is ignored and no telegram is sent to the bus; if enable on long press action a learn scene telegram is sent to the bus.	
Object enable scene learning from bus	disabled / enabled
If this parameter is enabled you have a communication object (size = 1 bit) in order to enable / disable runtime from bus the sending of the "learn scene telegram". When this object receives a telegram "1" then the function associated to the long press of the button (send the telegram storage scenario) is enabled, when it receives a telegram "0" the command associated with the long press is not sent.	

Commands sequences

This function allows you to associate to short and long press, sequences of different commands on the bus.

For each button this function is available for short and long press or as toggle function.

The sequence consists of 2 or 3 commands which can each be sized as 1 bit or 1 byte.

Once defined the number of elements in the sequence (2 or 3) and their size (1-bit / 1 byte), you can associate different commands to each

element of the sequence or decide to send commands only on one of the two events.

The waiting time between a command and the next is fixed in 1 second.

Each object communication can be connected to a different group address.

For example it is possible to define a sequence:

obj	dimension	short press (operation 1)	long press (operation 2)
A	1 bit	ON (to actuators)	OFF (to actuators)
B	1 byte	100% (to a dimmer)	0% (to a dimmer)
C	1 byte	COMFORT (to thermostat) a	ECONOMY (to thermostat) a

Set RGB color

This function allows you to associate a short press of the button to a command on the bus in order to set a RGB color. The "RGB object type" parameter defines whether the command is sent with a single 3-byte object or 3x1-byte objects. It is also possible to enable a feature associated with a long press that allows to change the color which is sent with a short press. During long press the RGB central bar displays the color transition and at the time of release the selected color is stored; this means that from now every time a short press is performed the new color is sent on the bus. When the device is powered off and on the last selected color is kept in memory.

The "Enable sending color during transition" option allows you to send all color transitions during long press so that each color can be displayed on another device, not just on the RGB bar.

MUR / DND

This function allows you to configure a key to send 1-bit commands with DND (do not disturb), MUR (make up room) or reset both signals - according to the sequence described below.

Value of parameter "command associated" (column "cmd") defines which values are sent on the 2 x 1 bit objects

cmd	Action	DND	MUR	Note
MUR	enable	0	1	MUR co sends "1" DND co sends "0"
MUR	disable	-	0	MUR co sends "0"
MUR	toggle	MUR enable/disable alternate		
DND	enable	1	0	DND co sends "1" MUR co sends "0"
DND	disable	0	-	DND co sends "0"
DND	toggle	DND enable/disable alternate		
Loop		0	1	Loop among these 3 sets
		1	0	
		0	0	

It is possible to associate a color to each of the 3 states (DND active, MUR active, MUR & DND not active); this color change the RGB bar (present on RGB range); it's also possible to send the same color to another device using a 3Byte Object DPT 232.600 RGB value 3x(0..255)

Loop among values

With this function you can configure a button to send a 1-byte value in sequence. The sequence is composed of a number of values between 3 and 9. Each time a pressure (or release according to the "active edge" parameter) is done a value is sent following the order set in ETS: from the first (A) to the last (I).

Two object are available:

<Button x> Loop value Output:

this object is for sending the step by step sequence

<Button x> Loop value feedback:

this object is to receive a value from the bus ; if it corresponds to any value set in the sequence then it synchronize to the related step.

6. Led

Each button has an associated white led that can be configured by ETS as:

Always OFF	Led is OFF
Always ON	Led is ON
Bus controlled	Led is lit on or off upon the telegram receive from bus ; initial state and led behaviour (fixed or blink) can be configured

7. RGB Led

This page is always available but the RGB bar is present only on the 9025 RGB range. For the standard range the RGB bar is not present and all the RGB effects cannot be performed.

RGB General

KNX PARAMETER	SETTINGS
Brightness limit	none day-night percentage
none: no limit day-night: a default value for night and day can be set and 1 bit object can be addressed to switch from night to day and vice versa percentage: this option enables a 1-byte communication object to change the LED illumination value by using a command %	

RGB Function

KNX PARAMETER	SETTINGS
RGB main function	nothing classic RGB KNX feedback physical dimension thermostat feedback [1] demo color loop
[1] visible only if thermostat function is enabled	
nothing: no function classic RGB: with this option you can change the color of the RGB bar by 3x1 byte obj or by a 3byte object. It is also possible to set the RGB LED in blink mode or turn it on / off by bus KNX feedback: with this option you can display up to five 1-bit objects on which send on / off telegrams. When the "0" or "1" value (according to parameter setting) is received, you can bring the color of the RGB bar to a defined - fixed or blinking - value. Receiving a new telegram on another object 1 bit of the KNX feedback function cause the RGB bar to light a new color.	

physical dimension: with this option, you can use the RGB bar to display the value associated with a physical size. The color of the RGB bar will change based on the received value to give a visual indication. You can choose a standard size (temperature, energy, etc.) or a generic datapoint (1,2 and 4 bytes available) and assign a color to the minimum value and another to the maximum value. The intermediate values between min and max will be displayed with colors between the selected ones, according to the color wheel - clockwise (CW) or counter clockwise (CCW). If the min and max values are exceeded the RGB bar blink can be activated to indicate alarms or malfunctions.

demo color loop: this feature activates an automatic color change sequence; you can define the color range (warm / cold colors or all colors) and the transition time between two colors. With the CO object #59 <RGB> Stop Color Loop it's possible to stop the loop with telegram "0" and then to start it again with telegram "1". When the loop is stopped you can define a fixed color for this status. When it's needed to have more than one 9025 device with demo color loop running and keep them synchronized you can select one device as a "master" by setting "T" flag = 1 in object #59 and link them with all the other objects #59 of the others 9025 (slaves). Every time the master change color will keep the other device synchronized. Please check to set all the parameters "color led" and "time of color change" to the same value and to start them at the same time.

thermostat feedback^[1]: with this option, the RGB bar will display a color related with the thermostat and defined by the parameter "thermostat data to show"

RGB temporary function	nothing button press thermostat feedback [1]
[1] visible only if thermostat function is enabled	
<p>This parameter sets the behaviour of the RGB bar in temporary mode; in this mode the RGB color change temporarily according to the parameters and after that it returns into the previous mode.</p> <p>nothing: no function button press: a color is displayed each time the key is pressed for a defined time. thermostat feedback [1]: here the RGB bar shows the HVAC mode or the Heat/Cool mode or the Setpoint every time that these values changes due to a button press.</p>	
RGB step light mode	disabled / enabled
<p>Enabling this function a 1 bit communication object is shown, it has the highest priority in the color setting of the RGB bar. When an activation telegram is received on this object, the RGB bar assumes the color set by parameter and this value does not change until it receives a deactivation telegram.</p>	

8. Temperature

The "Temperature" page allows you to configure the temperature measurement source to be used. This page is visible only if the "thermostat" or the "control panel" or "temperature sensor" is selected.

KNX PARAMETER	SETTINGS
Temperature source	frontal probe rear probe mix frontal/rear probe KNX probe mix frontal/KNX probe mix rear/KNX probe

<p>Frontal probe: is the embedd sensor included in the device</p> <p>Rear probe: is the additional probe that can be connected to the 2 poles terminal present on the back of the product. The sensor shall be selected between eelectron codes TS001A01ACC or TS01B01ACC and in page "Input" the rear input shall be set as "additional probe"</p> <p>KNX probe: with KNX probe is intended a remote sensor that send cyclically the temperature measurement via bus.</p>	
Temperature sensor calibration	-10°C ÷ +10°C with resolution, 0,1°C
<p>It's possible to add an offset to the temperature value measured by the probe before it is sent on the bus or made available for reading.</p>	
Sending interval	never 30 min
	1 min 1 h
	5 min 4 h
	10 min 12 h
<p>15 min 24 h</p>	
<p>If you enable the periodic sending the sending interval is set by this parameter.</p>	
Sending on variation	never / from 0.1 to 1.5°C
<p>Sending of values can be set also by checking the difference between current and previous value.</p>	

9. Temperature Probes

NTC temperature probe: eelectron code TS01A01ACC or TS01B01ACC.



TS01A01ACC (from -20°C to +100°C)

TS01B01ACC (from -50°C to +60°C)

Max. length of Connecting Cable: ≤ 20 m (twisted cable)

TS01A01ACC	
Dimensions in millimetres NTC resistance tolerance: $\pm 3\%$ Measure range $-20^{\circ}\text{C} \div +100^{\circ}\text{C}$ Cable: 2 wire single insulation Cable colour: Black NTC colour: Black ⚠ Warning: keep at least 6 mm from all live parts	

TS01B01ACC	
D1 = 9 mm D2 = 4 mm L2 = 49 mm L1 = 1250 mm NTC resistance tolerance: $\pm 2\%$ Measure range $-50^{\circ}\text{C} \div +60^{\circ}\text{C}$ Cable: 2 wire double insulation Cable colour: White NTC colour: White ⚠ Warning: keep at least 3 mm from all live parts	

10. Temperature Sensor Function

KNX PARAMETER	SETTINGS
Enable threshold T1 (low)	disabled / enabled
Two different thresholds for temperature can be enabled and, for each thresholds, send a telegram command telegram (1 bit) whenever the measured temperature exceeds or falls below the threshold. For each threshold can be set whether to send the telegram "1" when the measured temperature "T" exceeds the threshold temperature "Tx" and then send the telegram "0" when the measured temperature "T" becomes less than the threshold temperature "Tx" or vice versa.	
Enable threshold T2 (high)	disabled / enabled
See description of "Enable threshold T1 (low)".	
Value threshold T1	$-40^{\circ}\text{C} \div +90^{\circ}\text{C}$
Value threshold T2	$-40^{\circ}\text{C} \div +90^{\circ}\text{C}$
Telegram to send when T < T1	Telegram "0" Telegram "1"
Telegram to send when T > T2	Telegram "0" Telegram "1"
Object enable for Trigger 1 and 2	hide / show
It's possible to enable/disable the threshold function with a communication object. When this object is enabled and receives a telegram "1" the temperature probe is active and sends trigger telegrams according to thresholds T1 and T2 values; otherwise only temperature value is periodically sent.	
Initial value for object enable (1) / disable (0)	0 / 1
Allows to initialize enable object as active (1) or inactive (0) after power on, reset or download.	

11. Thermostat Function

The temperature function can be configured as a thermostat to control the temperature of a room or area by driving heating or cooling equipment / air conditioning fan coils / valves or through commands on / off to heating /cooling elements such as radiators, heat pumps, split, etc. ..



Thermostat operates temperature in a range from -9.9 ° C to + 99.9 ° C with 0.1°C resolution.

Setpoint values (including SETPOINT MODE) from the bus are accepted in a range from 10°C to 50°C

Target Setpoint Settings

The control setpoint can be changed by bus in two different ways, via one of these objects:

HVAC Mode
SETPOINT Mode

The right policy to adopt depend from the device that acts as a master, a time thermostat, a control panel or a SW supervisor. Here the list of object for changing the active mode or setpoint value by bus.

SETPOINT MODE object

When "Thermostat control mode" parameter is selected with the value SETPOINT MODE, object HVAC Mode is no longer visible.

Each time the thermostat receives a value on object SETPOINT MODE (2 byte size), it is used as setpoint for temperature control.

HVAC MODE object (switched heat / cool)

Using the object HVAC MODE (1 byte size), you can set the thermostat in one of the following

modes: OFF; ECONOMY; STANDBY; COMFORT; each mode is associated with a setpoint set by a ETS parameter.

OFF mode is associate to setpoint antifreeze in heating mode and high temperature protection in cooling mode.

HVAC MODE object (automatic heat / cool)

Behaviour for this value of parameter "Thermostat control mode" is the same as above described but the switching from heating to cooling mode and vice versa is automatic. With this setting it is necessary to set an insensitive zone as in parameter "Dead zone".

Whenever temperature becomes greater than : **Setpoint comfort heating + (Dead Band / 2)** active control is cooling; when temperature becomes less than: **Setpoint comfort cooling - (Dead Band / 2)** active control is heating.

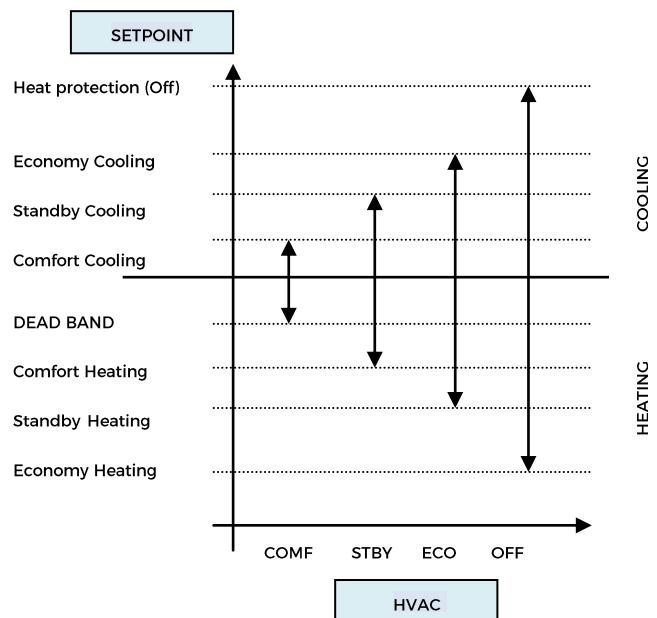

SETPOINT COMFORT object

SETPOINT STANDBY object

SETPOINT ECONOMY object

These 2 byte objects are used to set the setpoint values for COMFORT, STAND-BY, ECONOMY mode.

Whenever change, the setpoint are in saved in memory.

After download these setpoint are reset to values according to ETS parameter; on power up these object are set according to last values before power down.



Use these communication objects to change current setpoint for every HVAC Mode according to the current active control (heating or cooling)

SETPOINT OBJECTS	
Telegram received on:	Setpoint changed:
ECONOMY (OBJ # 82)	Setpoint economy cooling
STANDBY (OBJ # 83)	Setpoint standby cooling
COMFORT (OBJ # 84)	Setpoint comfort cooling
COMFORT (OBJ # 81)	Setpoint comfort heating
STANDBY (OBJ # 80)	Setpoint standby heating
ECONOMY (OBJ # 79)	Setpoint economy heating

COMFORT object

COMFORT object (1 bit size) is visible only when "Thermostat control mode" parameter is selected with the value HVAC MODE.

When a telegram "1" is received thermostat goes in COMFORT mode (it applies for both heating and cooling)

On receipt of a telegram "0", thermostat returns to the mode set by HVAC MODE object.

COMFORT mode can be set also with timing: after a time set by a parameter thermostat returns in the previous mode.

KNX PARAMETER	SETTINGS
Comfort Object	Time limited Time unlimited
Comfort Overwrite Time	1.. 255 (minutes)

WINDOW CONTACT object

This object, if enabled, has higher priority than HVAC MODE, SETPOINT MODE, COMFORT objects.

When a telegram is received ("0" or "1") on the communication object WINDOW CONTACT thermostat enters a power saving mode:

BUILDING PROTECTION (if running in HVAC MODE) or Setpoint antifreeze /high temperature protection (if running in SETPOINT MODE)

If the telegram received indicates that the window is opened, thermostat change its mode or setpoint after 1 minute from the reception of the telegram.

When it receive a telegram corresponding to state "window closed" it restores the previous mode, always with a delay of 1 minute . The value of SETPOINT ADJUSTMENT (if enabled) is always restored.

SETPOINT ADJUSTMENT object

The object SETPOINT ADJUSTMENT allows you to temporarily change the setpoint value used by the thermostat applying an offset to the current value.

If the thermostat is operating in "HVAC MODE" the offset value is applied from the time of receipt of a valid telegram on object SETPOINT ADJUSTMENT until this value does not change, even in case of change of the active mode (Comfort and Standby); when device enters Economy mode this value can be reset or not according to the parameter "Reset delta setpointon HVAC economy). Entering Building Protection mode the value of object SETPOINT ADJUSTMENT is forced to 0.

Similarly, if the thermostat is operating in SETPOINT MODE the offset value is applied also when the setpoint value received on this object changes.

ADDITIONAL TEMPERATURE object

It is possible to enable the reading of a second external probe which sends the measurement data to the thermostat via the communication object ADDITIONAL TEMPERATURE of size 2 bytes.

Surveillance time for KNX probe	10..255 (min)
Whenever the thermostat receive a valid data from KNX probe it consider this value in the calculation of the measured temperature and reset the internal time (monitoring time).	



If KNX probe is enabled the monitoring time is used to check if the additional temperature sensor periodically sends valid data to the thermostat. This mechanism avoids to consider as valid some data which can be old hours or days, for example if the additional sensor should fail or the thermostat could not receive data for long time.



It is strongly recommended to set a value for surveillance time of the additional sensor more than twice of the period set for the cyclical sending of the additional sensor.

ACTUAL SETPOINT object

The ACTUAL SETPOINT object send the setpoint in use and is sent every time:

- The value of HVAC mode object changes
- The value BASE SETPOINT changes
- The value of SETPOINT ADJUSTMENT object changes
- After download
- One minute after power on

Two points on/off

Control algorithm "2 points on / off" is used to control heating or cooling elements that can be controlled by switching on and off of the same elements, radiators, under floor heating with on-off valves, boilers, etc. ..

When the thermostat switches to "winter mode" (heat mode) sends a off command on object ON/OFF COOLING and operates the control only through the object ON/OFF HEATING (the object ON/OFF COOLING is therefore not updated anymore until it returns in "cooling mode").

Therefore in the transition from " winter" to "summer" mode sends a off command on ON/OFF HEATING commands and activates the control through the object ON/OFF COOLING.

on/off control in heating mode:

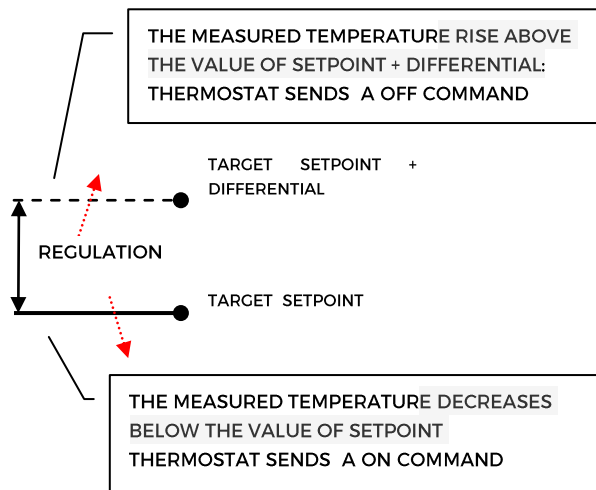

on/off control in cooling mode:

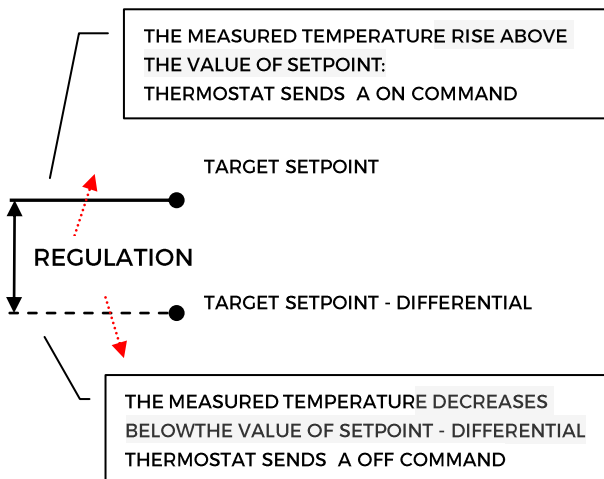

Integral proportional control PWM

Integral proportional control with PWM is an algorithm that reduces the effects of hysteresis around the set point value by adjusting the controls on the values ranging from 0% to 100% where 0% means “control off” and 100% means “maximum control action”.

Once a cycle time is defined the thermostat sets the actuator to ON for a fraction of the cycle time and OFF for the remaining part. Driving the actuator with the control value of 80% means that it is active (i.e., ON) for 80% of cycle time and OFF for the remaining 20%.

KNX PARAMETER	SETTINGS
Cycle time (TCp)	10, 20, 30, 60 min
It defines the time interval.	
Proportional band (Bp)	1, 2, 3, 4, 5 °C
The proportional band BP is a range of temperatures between “Setpoint” and “Setpoint-Bp” in heating mode and between “Setpoint” and “Setpoint+Bp” in cooling mode, within this interval thermostat controls the temperature using the proportional algorithm; outside It drives actuator always in ON or OFF. When temperature is inside this range device wait the end of the cycle time before calculating the duty cycle of the next cycle. When temperature is outside of this range : below “Setpoint-Bp” in heating mode or above “Setpoint+Bp” in cooling mode it starts a new cycle as soon as temperature enters the Bp	
Integration time (Ti)	5 .. 250 min
Defines the integration time	

Integral proportional contr. continuous

This setting is very similar to “Integral proportional control with PWM” in terms of algorithm and parameters. This mode uses a 1 byte object (% value) to send the command on the bus .

Fan coil on/off

Fan coil is a device that controls the flow of cooling / heating liquid driving a valve (2-pipe fan coil) or two valves (4-pipe fan coil).

Liquid exchanges heat/cool with the environment through a ventilation system controlled by a fan. The fan is driven by an engine that typically has 3 windings that can be enabled at 3 distinct speeds.

Control logic for a 3 speed fan coil in heating:
When temperature increasing

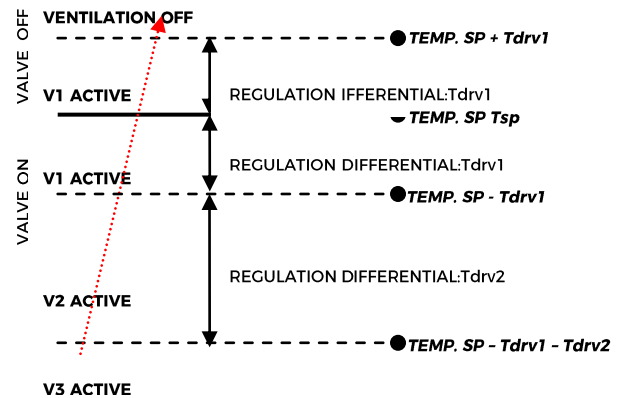

When temperature decreasing

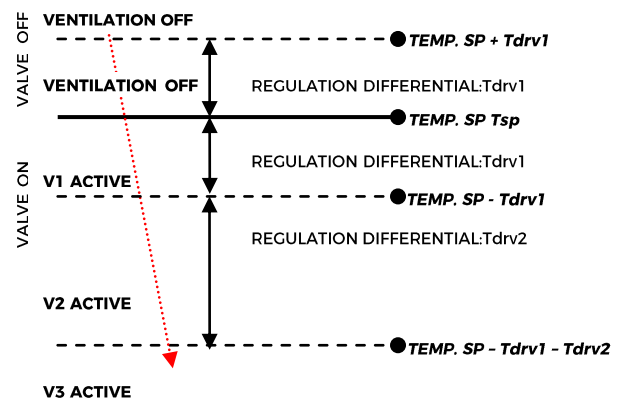

Where:

T_{sp} : Target setpoint temperature

T_{drv1} : regulation differential in heating for V1
Speed

T_{drv2} : regulation differential in heating for V2
Speed

Control logic for a 3 speed fan coil in cooling:
When temperature decreasing

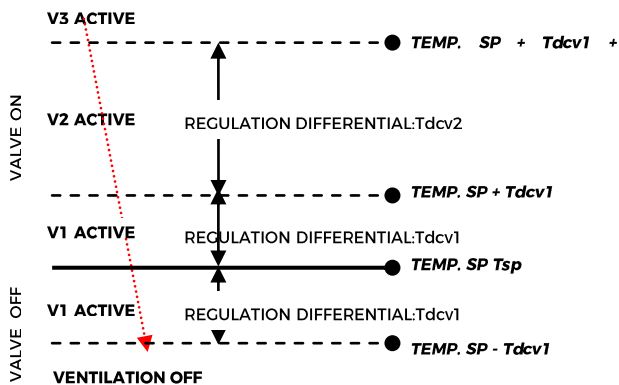

When temperature decreasing

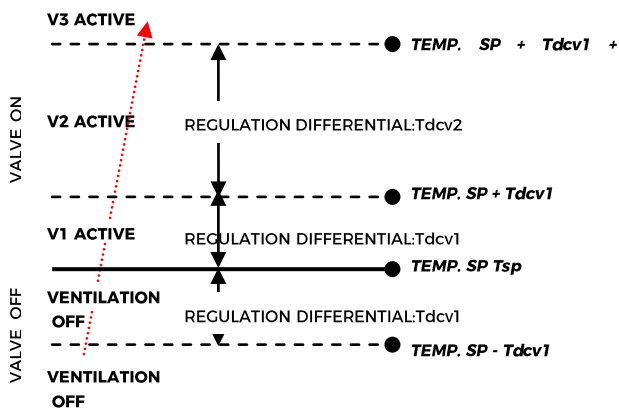

Where:

- T_{sp} : Target setpoint temperature
 T_{dcv1} : regulation differential in cooling for V1 Speed
 T_{dcv2} : regulation differential in cooling for V2 Speed

Fan coil control %

Logic and parameters are the same used in On/off with PWM control mode; the difference is that now the proportional value is sent to the bus via a 1 byte object format as a % value from 0% to 100%.

This mode is useful to control fan coils (selecting 2 or 4 pipes) or generic proportional actuators as valve drivers only linking the 1 byte communication object and avoiding to link the valve objects.

CONTINUOUS CONTROL object

This 1 Byte object send % control value to actuator.

Additional valve



In fan coil mode it is possible, in 4 pipes systems to enable an additional valve object. This object is used when the thermostat has to manage 2 different system , one in heating and one in cooling .

Suppose to have a system when floor heating is required in heating mode and a 3 speed fan coil system is required in cooling mode.

To manage this system it is necessary to :

- Set parameter “Thermostat option > use thermostat to control fan coil” = yes
- Set parameter “Fan coil ON - OFF control>Enable fan speed on” or “Fan coil continuous control > Enable fan speed on” =cooling
- Set parameter “Fan coil ON - OFF control > System type” or “Fan coil continuous control > System type” = 4 pipes
- Set parameter “Enable additional valve”=enabled

- Set parameter “Additional valve>Enable valve when”=heating
- Set parameter “Additional valve>Control algorithm” = *according to your system request*

is 0 °C (according to KNX DPT_Value_Temp 9.001)

Force fan coil speed

In fan coil operation (in 1-bit or 1-byte mode), you can force the use of just one speed and bypass the automatic speed selection. This mode is useful, for example, in small rooms such as hotel rooms, for example or in any case where the fan speed may bring noise. To activate forcing, you must act on the 1-bit object that selects AUTO / MAN and then on the object that activates the desired speed (3x1 1-bit object or 1 object at 1-byte in% mode)

Ventilation mode

When using fan coil, you can also activate "fan" or "ventilation" mode. In this mode, the fan coil will never turn off the fan even when, after reaching the desired setpoint, the heat / cool valve closes. To select the fan speed used in ventilation mode the “force fan speed object” must be set, in fact in AUTO mode the ventilation stops when setpoint is reached. It is also possible to make the "ventilation" mode always active without having to turn it on / off via a communication object.

Temperature probe failure / out of range measurement



If the temperature probe is disconnected or in short circuit the control action is interrupted and the controlled actuators are switched off.



The value of temperature sent on the bus in case of probe disconnection or short circuit or for out of range measured value

<General> ALARM object

In event of temperature probe failure / out of range measurement a telegram from 1 bit communication object - obj #47: <General> Alarm” - is sent on the bus with value 1. As soon the temperature sensor works good again a value “0” is transmitted.

To correctly manage the use of internal / rear / KNX probe refers to the following possible configuration modes:

CONFIGURATION MODE 1
Frontal probe
if the temperature probe is disconnected or in short circuit the control action is interrupted and the controlled actuators are switched off.
probe disconnection / short circuit / out of range measurement:
Obj #71 “Actual temperature” is not sent Obj #47 “Alarm” transmits “1”

CONFIGURATION MODE 2
Rear probe only
if the temperature probe is disconnected or in short circuit the control action is interrupted and the controlled actuators are switched off.
probe disconnection / short circuit / out of range measurement:
Obj #71 “Actual temperature” is not sent Obj #47 “Alarm” transmits “1”

CONFIGURATION MODE 3

KNX probe only

The KNX probe is read by considering last value received on Obj #72 “KNX probe temperature”.

If the KNX probe value is out of range or the surveillance time expires without any message received, thermostat start considering only the internal probe until it receives a new valid value from the KNX probe; in this case the additional value is taken in count again.

Obj #47 “Alarm” transmits “1” until the KNX probe is received again

CONFIGURATION MODE 4

Mix of frontal and rear probe

The value of temperature sent on the bus is the pounded average between frontal and rear probe values.

If one of the 2 probes is not working (probe disconnection / short circuit / out of range measurement) thermostat start considering only the other probe.

Obj #47 “Alarm” transmits “1”

CONFIGURATION MODE 5

Mix of frontal and KNX probe

Mix of rear and KNX probe

The KNX probe is read by considering last value received on Obj #72 “KNX probe temperature”.

The value of temperature sent on the bus is the pounded average between frontal and KNX probe values.

If the KNX probe value is out of range or the surveillance time expires without any message received, thermostat start considering only the other probe until it receives a new valid value from the KNX probe; in this case the additional value is taken in count again.

12. Thermostat behaviour on bus failure, recovery and download.

Behaviour on bus voltage failure

On failure of bus voltage no actions are executed by the device; behaviour of controlled actuators must be set using their own parameters.

Behaviour on bus voltage recovery

On bus voltage recovery all the communication objects are set to 0 except for objects for which a parameter is defined for the initial value; thermostat keeps these values in memory and restore them after recovery:

- Heat / Cool mode
- HVAC Mode
- Base Setpoint
- Setpoint Adjustment
- Force value in manual mode
- Ventilation

Control values (i.e. commands to actuators) are calculated using actual setpoint and temperature.



After power on device recalculates the commands to actuators and switch them on, if necessary, otherwise does not carry out any action; you are recommended to set the behaviour of actuator in order to switch the heating / cooling equipment off after bus power on.

Behaviour ETS Download

After download it's possible to set initial value of:
 Heat / Cool mode
 HVAC Mode
 Ventilation

For other communications objects the behaviour is identical to bus voltage recovery.

13. Control panel

If you enable the control panel you have a set of communication objects that allow the button to exchange data with a room temperature controller device. This mode allows you to provide a button set to interface with a device that has the on-board temperature control algorithms. Using the "special button" is recommended.

Available objects for Control Panel:

Function	Description		Direction
OFF management	command	Send command	→ to bus
	feedback	Receive status	← from bus
	toggle	when 1 bit is received then command is toggled and sent	← from bus
Heat/Cool	command	Send command	→ to bus
	feedback	Receive status	← from bus
	toggle	when 1 bit is received then command is toggled and sent	← from bus
	Valve heat	receive valve status	← from bus
	Valve cool	receive valve status	← from bus
AUTO/MAN management	command	Send command	→ to bus
	feedback	Receive status	← from bus
	toggle	when 1 bit is received then command is toggled and sent	← from bus
SETPOINT management	SP reference	receive the ref. temperature	← from bus
	SP actual	send Actual Setpoint	→ to bus
	decrease / increase	when 1 bit is received then actual setpoint is increased/decreased and sent	← from bus
	reset adjustment	when received the setpoint adj. is reset	← from bus

Function	Description		Direction
HVAC and HVAC CONTROL management	command	send command	→ to bus
	feedback	receive status	← from bus
	decrease / increase	when 1 bit is received then HVAC value is increased/decreased	← from bus
FANCOIL ON/OFF management	Speed <x> command	send command	→ to bus
	Speed <x> Feedback	receive status	← from bus
	decrease / increase	when 1 bit is received then fan speed s increased/decreased	← from bus
FANCOIL % management	Speed value command	send command	→ to bus
	Speed value Feedback	receive status	← from bus
	decrease / increase	when 1 bit is received then fan speed s increased/decreased	← from bus

14. Input

The rear input can be configured as analogical or digital input. When configured as an analogical input can be connected to a temperature probe (code TS00A01KNX or TS00B01KNX) and used to make a mix of the measurement with the front probe or to handle with on / off a load such as a towel heater etc.

As digital input it can have all the features that are listed for the front buttons.

15. Humidistat

Version RH07A01KNX includes a humidity sensor to perform ambient humidity measurement with a tolerance of $\pm 2\%$ between 0% and 90% RH. It is possible to set 2 different threshold of relative humidity and send 1 bit commands of ON and OFF when trespassing the both thresholds from down to up and vice versa. These 1 bit objects and all the commands can be enabled and disabled runtime using a 1 bit communication object.

16. Logics

The logic functions are organized into groups of 3 objects: 2 inputs and 1 output, except the one called "logic expression" that will be described later. The scheme of logics is as follows:

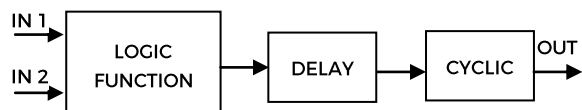

Inputs

Input datatypes can be bit, byte, float etc according to the selected logic.

IN1 is always present. IN2 maybe unused (or hidden directly by ETS).

Delay

The logic output can be delayed according to the ETS parameter, if a new value is received, the output is overwritten and the delay reset.

Cyclic

The delayed output can be retransmitted n times according to ETS parameters

Logic function

Logic function type is defined by an ETS parameter; here the list of functions:

FUNCTION NAME	DESCRIPTION
Disabled	The logic block is disabled, no parameter / object is visible.
bit no transfer	Only delay and retransmission. IN1 is a bit. IN2 is disabled. OUT is a bit.
byte no transfer	Only delay and retransmission. IN1 is a byte. IN2 is disabled. OUT is a byte.
bit NOT	OUT = NOT IN1 IN1 is a bit. IN2 is disabled. OUT is a bit.

bit AND	OUT = IN1 AND IN2 IN1 is a bit IN2 is a bit OUT is a bit.
bit OR	OUT = IN1 OR IN2 IN1 is a bit IN2 is a bit OUT is a bit.
bit NAND	OUT = NOT (IN1 AND IN2) IN1 is a bit IN2 is a bit OUT is a bit.
bit NOR	OUT = NOT (IN1 OR IN2) IN1 is a bit IN2 is a bit OUT is a bit.
bit XOR	OUT = IN1 XOR IN2 IN1 is a bit IN2 is a bit OUT is a bit.
bit XNOR	OUT = NOT (IN1 XOR IN2) IN1 is a bit IN2 is a bit OUT is a bit.
bit to byte conversion	2 ETS parameters: BYTE_0, BYTE_1. When 0 is received, BYTE_0 is sent. When 1 is received, BYTE_1 is sent. IN1 is a bit. IN2 is disabled. OUT is a byte.
byte to bit conversion	1 ETS parameter: BYTE_V. When a value equal to BYTE_V is received then a telegram 0,1, or nothing is sent. When a value different from BYTE_V is received then a telegram 0,1, or nothing is sent IN1 is a byte. IN2 is disabled. OUT is a bit.
byte threshold	1 ETS parameter: BYTE_V. When a value less or equal to BYTE_V is received then a telegram 0,1, or nothing is sent. When a value greater than BYTE_V is received then a telegram 0,1, or nothing is sent IN1 is a byte. IN2 is disabled. OUT is a bit.
2 byte float threshold	1 ETS parameter: 2BYTE_F. When a value less or equal to 2BYTE_F is received then a telegram 0,1, or nothing is sent. When a value greater than 2BYTE_F is received then a telegram 0,1, or nothing is sent IN1 is a 2 bytes float.

	IN2 is disabled. OUT is a bit.
4 byte float threshold	1 ETS parameter: 4BYTE_F. When a value less or equal to 4BYTE_F is received then a telegram 0,1, or nothing is sent. When a value greater than 4BYTE_F is received then a telegram 0,1, or nothing is sent IN1 is a 4 bytes float. IN2 is disabled. OUT is a bit.
Expression	See next paragraph

Expression

Logic expression can be used to implement custom logic and arithmetic operation between values received on the KNX bus.

The logic expression has 5 objects: 4 inputs and 1 output. The scheme of logic expression is as follows:

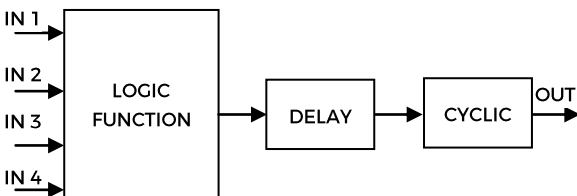

Inputs (A, B, C, D) and output (OUT) objects

The datapoints can be configured through an ETS parameter:

- bit
- unsigned byte
- signed byte
- unsigned 2 bytes
- signed 2 bytes
- float 2 bytes (eg. temperature, humidity, ...)
- unsigned 4 bytes
- signed 4 bytes
- float 4 bytes (eg. power, energy, ...)

Expression

Configurable through an ETS parameter of 16 (maximum) character string. The output of the logic is the arithmetic evaluation of this expression.

Inputs objects can be accessed through their letters (A, B, C, D), the result is sent to the delay block.

Permitted operands:

"+"	arithmetic sum
"-"	arithmetic subtraction
"*"	arithmetic multiplication
"/"	arithmetic division
"&"	logic AND
" "	logic OR
"^"	logic XOR
"!"	logic NOT
"(" and ")"	grouping operands

Expression examples:

"(A+B+C)/3"	calculate the mean of the A, B, C objects
"A*9/5+32"	convert object A Celsius degrees to Fahrenheit degrees
"A*1000"	convert object A KW to W
"A*3.6"	convert object A m/s to Km/h

- Quotation marks must not be included in expressions
- If wrong or unrecognized characters are used in expression then it will be not processed and discarded.

17. Virtual holder

Virtual holder is enabled by enabling corresponded parameter in page "General Settings".

The application field is typically the hotel room where, by using this feature, you can remove the Holder for access control.

This logical module provides a set of parameters and communication objects that, suitably configured, allow you to set up whether or not a person is occupying the room.

Definitions:

VH = Virtual Holder

CO = Communication Object

IN = CO that receives telegram from the bus

OUT = CO to send telegram on the bus

Welcome = event triggered when someone enters the room which was not occupied

Goodbye = event triggered when the room goes in status “unoccupied”

How it works

When one or more people enter the room, that event is recognized by the door opening and if, after it is closed, the customer's presence is still identified, then the logical module decides that the client is in the room otherwise it determines that he is out of the room. The minimum set of sensor requested for this logic to work properly is:

- one door contact for each door of the room, this contact must be detected by a KNX device in order to send on the bus the value “0” when door is closed and value 1 when door is opened
- at least one presence detector for each area; this presence detector can be KNX or conventional with dry contact output to be connected a KNX input. This device must send on the bus the value “1” when presence is detected and value 0 when presence is not detected.

Communication Objects

<VH> Room Booked	IN	1 bit
By setting this CO to “1” the status of the VH is set to “room booked”; when set to “0” the status is “room not booked”. The VH module can have different behaviour if the room is booked or not; default value for this status can be set using the “Booked state after download” parameter.		
<VH> Signal for guest (Type1)	IN	1 bit
<VH> Signal for service (Type2)	IN	1 bit
<VH> Signal for maintenance (Type3)	IN	1 bit
This COs can be used to communicate to the VH module who is entering the room. This can be		

achieved by using a KNX Access Control Reader (<i>Synchronicity</i> by eelectron) or by interfacing other access systems with KNX bus		
<VH> Presence for guest (Type1)	OUT	1 bit
<VH> Presence for service (Type2)	OUT	1 bit
<VH> Presence for maintenance (Type3)	OUT	1 bit
This COs can be used to send from VH module information about who entered the room to a supervisor or similar sw.		
<VH> Remote Inputs Enable (Global Enable)	IN	1 bit
See paragraph Remote Inputs Enable (Global Enable).		
<VH> Presence Output	OUT	1 bit
This CO send “1” when someone is detected inside the room (presence) and “0” when nobody is detected inside the room and the “presence wait time” has expired (absence).		
<VH> HVAC Output	OUT	1 byte
This CO is used to send HVAC commands in event of presence and absence. Commands can be set different if the room in booked or not and if the person who enter the room is guest, service or maintenance.		
<VH> Additional Output	OUT	1 byte
This CO is used to send commands in event of presence and absence. Commands can be set different if the room in booked or not and if the person who enter the room is guest, service or maintenance.		

Parameters - General



KNX PARAMETER	SETTINGS
Presence wait time	1 min to 3 hours
This parameter set the “wait time” for the VH module. The “wait time” is the time triggered by the opening and consequent closing of the door. During this time the room is in “wait “ mode and after this can go in “occupied” or “non	

occupied” status. Use values for this parameter that are not too small to avoid not recognizing people in the room and not too big to avoid to kkeep room service active for too long after customers leave.	
Cyclic presence send time	No cyclic send, 1 min to 1 hour
Object <VH> Presence Output can be send cyclically if this parameter is set different from “No cyclic send”.	
Presence sensor OFF latency	10 to 63 sec.
This parameter is related to the time set on the presence detector. The most of presence detectors keep the presence status for a configurable amount of seconds; set this parameter to the same value. It’s recommended to set this time duration at the minimum. If the presence detector is a conventional one (dry contact output connected to a KNX input) this time duration is the relay time. If the knob of the conventional presence detector is set to 10 sec. then set this parameter to 10 sec. as well.	
Send welcome on unexpected presence	do not send / send
This parameter defines the behavior when the VH module detects a presence inside the room and is in “not occupied” status (unexpected presence). It’s possibile to send or not the welcome event.	
Remote input state after download	disabled / enabled
See paragraph Remote Sensor inputs (Global Enable).	
Booked status after download	not booked / booked
Set the initial value for the object <VH> Room Booked	
Absence with door open (deny=if door open presence is active)	allow / deny
This parameter defines the behavior when the VH module detects the open port. If the door remains open longer than the wait time, this parameter defines whether to keep the room in	

“occupied” state or not.

Parameters – Remote inputs

In this page the installer must set which type of sensor are linked to the VH module

KNX PARAMETER	SETTINGS
Remote input <x>	disabled door presence bus sniffer
<p>disabled: non used</p> <p>door: set this option if the communication object <VH> Remote Input x Door is linked to a door contact KNX input.</p> <p>presence: set this option if the communication object <VH> Remote Input x Presence is linked to a presence detector KNX communication object.</p> <p>Bus sniffer: set this option if the communication object <VH> Remote Input x Sniffer is linked to a generic CO used in the room.</p>	
 <p>Usage of the Bus Sniffer Option.</p> <p>When a person occupies a room interacts with it. Turning on or off a light in the main room or in the bathroom gives indication of the presence of people inside the room. To reduce the risk of not correctly identifying the "occupied room" status, it is recommended to connect a "bus sniffer" input to all the 1 bit objects that can be sent to the bus only by the presence of a person in the room such as bathroom or mirror lights or window contact or bedside light, etc ...</p>	
 <p>WARNING ON REMOTE INPUT <X> CO</p> <ul style="list-style-type: none"> - a Remote Input CO (type door) must be connected only to one single door contant on/off telegram; - a Remote Input CO (type presence) must be connected only to one single device with 	

presence on/off telegram; - a Remote Input CO (type bus sniffer) can be connected to more than one devices.	
Local input	disabled door presence
Local input can be connected either to a door contact or conventional presence detector ; by setting this input as “digital input” and “activation press/release” it’s possible to send also telegram on the KNX bus for other purposes.	

Remote Inputs Enable (Global Enable)

This CO is used when you need to consider 2 adjacent rooms as separated or joined as if they were a single room (suite room).

This possibility must be considered during installation, so communication objects must be connected as described below if you want to switch from one configuration (2 single rooms) to another (one double room) and vice versa.

To handle this situation both "Virtual Holder" modules of the 2 single rooms must be activated and configured.

The principle is to connect the sensors (door, presence and sniffer) of room 1 to room 2 and vice versa; however, the "Subordinate to Remote Inputs Enable" parameter for each single Remote Input should be properly configured.

For sensors located in Room 1, this parameter must be set to "not subordinate" on room 1 "Virtual Holder" while should be “subordinated” to room 2 Virtual Holder.

The same principle must be applied to room 2 sensors that are "subordinate" only for the connections to room 1.

Setting the value "1" on the "Remote Inputs Enable" object for the "Virtual Holder" of each room each module will consider all sensors connected to it; by setting this CO to "0" each

"Virtual Holder" only considers the sensors connected to its “remote inputs” set as "not subordinate"

For a connection diagram of this function see Fig. 2

18. Wrong application download

If the wrong ETS application is downloaded then KNX/EIB led starts blinking and device is not operative on the bus. A power reset must be done or the correct ETS application must be downloaded.

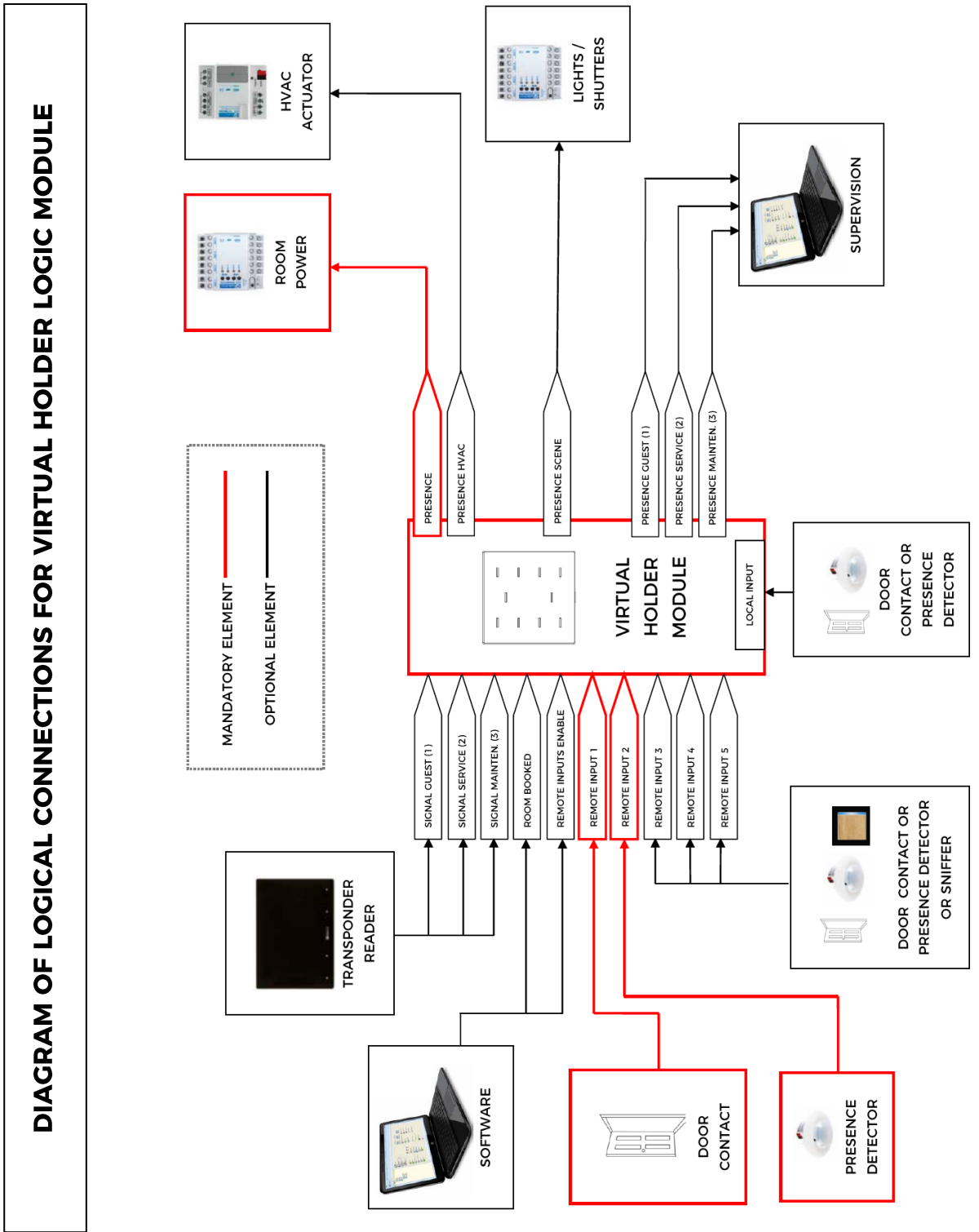

FIG. 1

DIAGRAM OF LOGICAL CONNECTIONS FOR REMOTE SENSOR INPUT ENABLE (GLOBAL ENABLE)

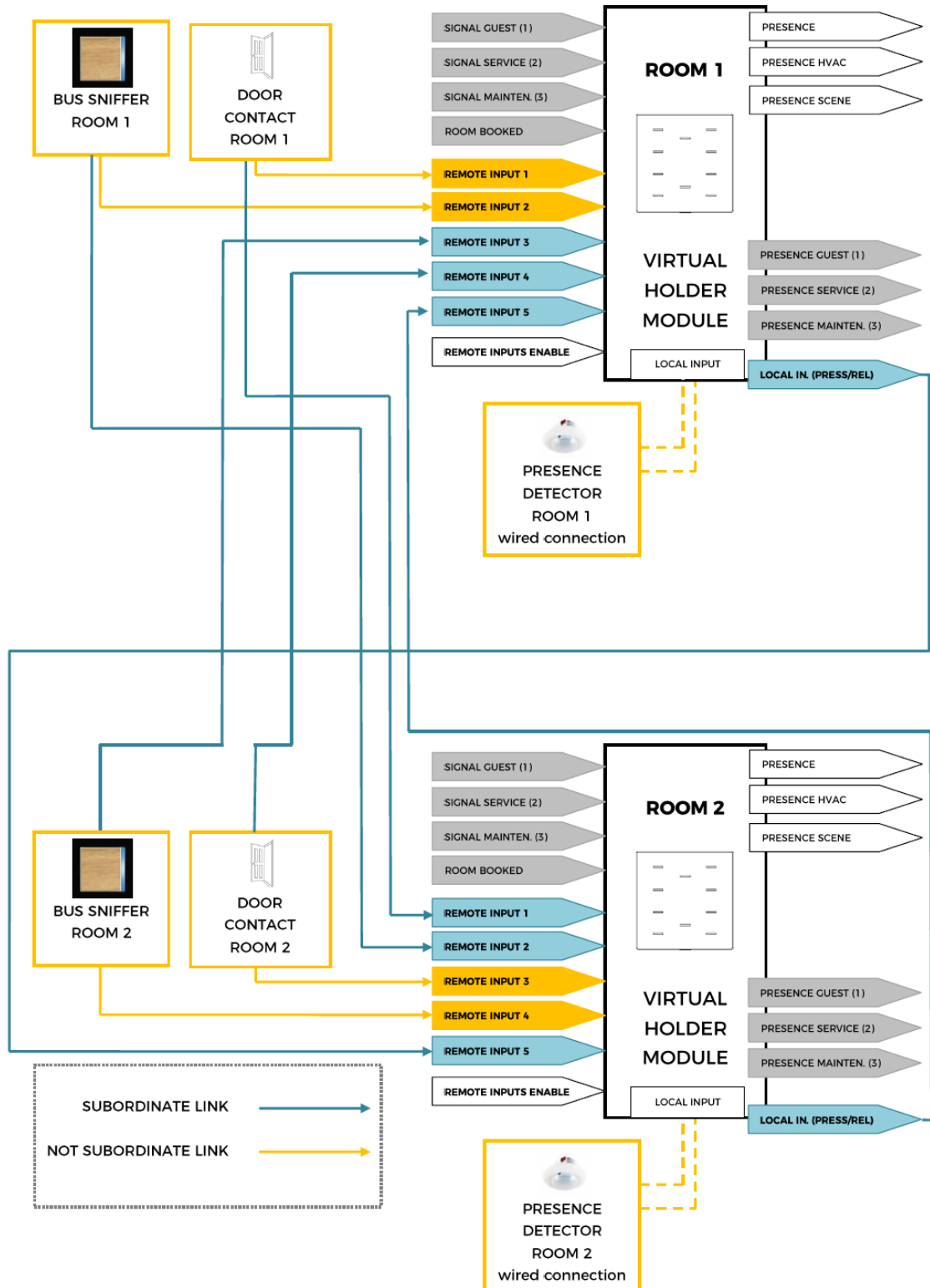

FIG. 2