



MINiBOX 40 v2

Multifunction Actuator with 4 Outputs and a Fan Coil Module

ZIOMN40V2

Application programme version: [1.2]

User manual edition: [1.2]_a

CONTENTS

Contents	2
1 Introduction	3
1.1 MINiBOX 40 v2	3
1.2 Installation	4
1.3 Start-Up and Power Loss	5
2 Configuration	6
2.1 General	6
2.2 Outputs	8
2.3 Logic Functions	9
2.4 Scene Temporisatation	10
2.5 Manual Control	12
ANNEX I. Communication Objects	17

1 INTRODUCTION

1.1 MINiBOX 40 v2

MINiBOX 40 v2 from Zennio is a versatile KNX actuator featuring a wide variety of functions and four relay outputs for a variety of applications, such as controlling shutter drives or a fan coil unit.

The most outstanding features are:

- **4 relay outputs**, configurable as:
 - Up to **2 independent shutter channels** (with or without slats),
 - Up to **4 individual ON/OFF outputs**,
 - Up to **1 two-pipe fan coil module** where both the fan speed control and the valve control are performed through relays,
 - A combination of the above.
- **10 customisable, multi-operation logic functions.**
- **Scene-triggered action control**, with an optional delay in the execution.
- **Manual operation / supervision** of the 4 relay outputs through the on-board pushbuttons and LEDs.
- **Heartbeat** or periodical “still-alive” notification.
- **Relay Switches Counter.**

1.2 INSTALLATION

MINiBOX 40 v2 connects to the KNX bus through the on-board KNX connector.

Once the device is provided with power from the KNX bus, both the individual address and the associated application programme may be downloaded.

This device does not need any additional external power since it is entirely powered through the KNX bus.

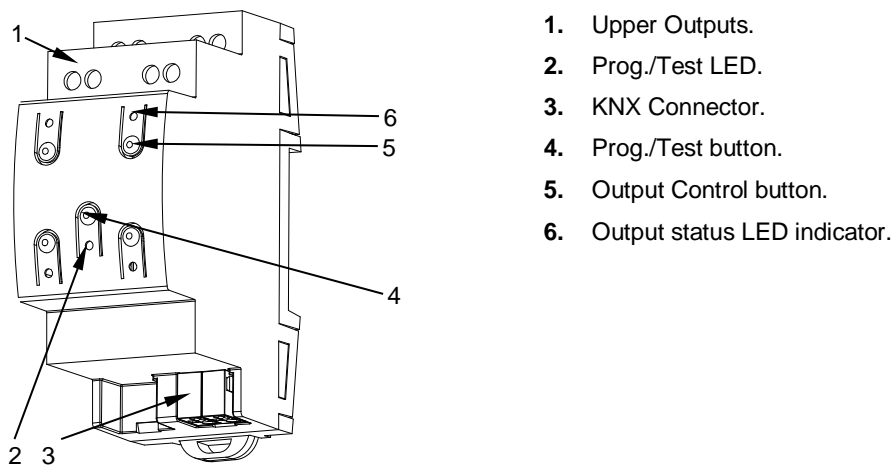

Figure 1. MINiBOX 40 v2. Elements

The main elements of the device are described next.

- **Prog./Test Pushbutton (4):** a short press on this button sets the device into the programming mode, making the associated LED (5) light in red.

Note: if this button is held while plugging the device into the KNX bus, the device will enter into **safe mode**. In such case, the LED will blink in red every 0.5 seconds.

- **Outputs (1):** output ports for the insertion of the stripped cables of the systems being controlled by the actuator (see section 2.2). Please secure the connection by means of the on-board screws.

To get detailed information about the technical features of this device, as well as on the installation and security procedures, please refer to the corresponding **Datasheet**, bundled with the original package of the device and also available at www.zennio.com.

1.3 START-UP AND POWER LOSS

During the start-up of the device, the Prog./Test LED will blink in blue colour for a few seconds before the device is ready. External orders will not be executed during this time, but afterwards.

Depending on the configuration, some specific actions will also be performed during the start-up. For example, the integrator can set whether the output channels should switch to a particular state and whether the device should send certain objects to the bus after the power recovery. Please consult the next sections of this document for further details.

On the other hand, when a bus power failure takes place, the device will interrupt any pending actions, and will save its state so it can be recovered once the power supply is restored.

For safety reasons, all **shutter channels** will be stopped (i.e., the relays will open) if a power loss takes place, while the individual outputs and the fan coil outputs will switch to the specific state configured in ETS (if any).

2 CONFIGURATION

2.1 GENERAL

After importing the corresponding database in ETS and adding the device into the topology of the desired project, the configuration process begins by entering the Parameters tab of the device.

ETS PARAMETERISATION

The only parameterisable screen that is always available is General. From this screen it is possible to activate/deactivate all the required functionality.

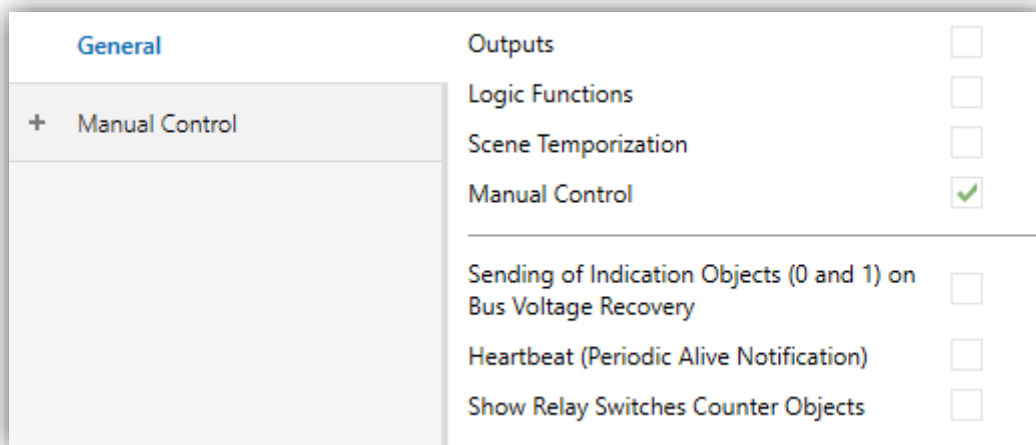

Figure 2. General

- **Outputs** [*disabled/enabled*]¹: enables o disables the “Outputs” tab on the left menu. See section 2.2 for more details.
- **Logic Functions** [*disabled/enabled*]: enables o disables the “Logic Functions” tab on the left menu. See section 2.3 for more details.
- **Scene Temporization** [*disabled/enabled*]: enables o disables the “Scene Temporization” tab on the left menu. See section 2.4 for more details.

¹ The default values of each parameter will be highlighted in blue in this document, as follows: [*default/rest of options*].

- **Manual Control** [*disabled/enabled*]: enables o disables the “Manual Control” tab on the left menu. See section 2.5 for more details.
- **Sending of Indication Objects (0 and 1) on Bus Voltage Recovery** [*disabled/enabled*]: this parameter lets the integrator activate two new communication objects (“Reset 0” and “Reset 1”), which will be sent to the KNX bus with values “0” and “1” respectively whenever the device begins operation (for example, after a bus power failure). It is possible to parameterise a certain **delay** [*0...255*] to this sending.

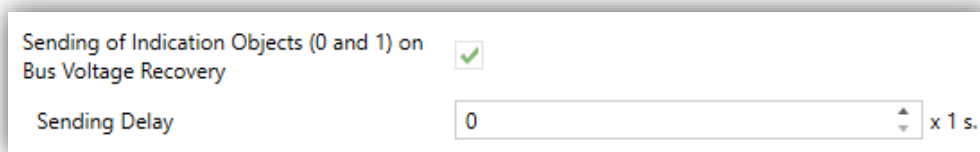

Figure 3. Sending of Indication objects on bus voltage recovery

- **Heartbeat (Periodic Alive Notification)** [*disabled/enabled*]: this parameter lets the integrator incorporate a one-bit object to the project (“[Heartbeat] Object to Send ‘1’”) that will be sent periodically with value “1” to notify that the device is still working (*still alive*).

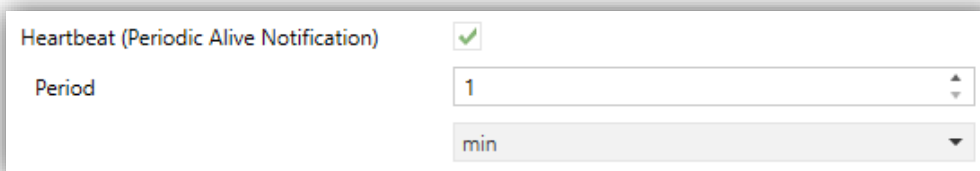

Figure 4. Heartbeat (Periodical Alive Notification).

Note: *The first sending after download or bus failure takes place with a delay of up to 255 seconds, to prevent bus overload. The following sendings match the period set.*

- **Show Relay Switches Counter Objects** [*disabled/enabled*]: enables two communication objects to keep track of the number of switches performed by each of the relays (“[Relay X] Number of Switches”) and the maximum number of switches carried out in a minute (“[Relay X] Maximum Switches per Minute”).

2.2 OUTPUTS

MINiBOX 40 v2 incorporates **4 relay outputs**, each configurable as a:

- **Individual binary outputs**, which allows an independent control of loads.
- **Shutter channels**, which allow controlling the motion of shutters or blinds.
- **One fan coil module**, which allows the control of the fan and the valve of two-pipe fan coil units.

For detailed information about the functionality and the configuration of the related parameters, please refer to the following specific manuals, all of them available in the MINiBOX 40 v2 product section at the Zennio homepage (www.zennio.com):

- **Individual outputs.**
- **Shutter channels.**
- **'Relays' fan coil.** Note that MINiBOX 40 v2 is only compatible with two-pipe fan coils and On/Off valves. Therefore, any references to four-pipe fan coils and 3-Point valves do not apply to this device.

2.3 LOGIC FUNCTIONS

This module makes it possible to perform numeric and binary operations to incoming values received from the KNX bus, and to send the results through other communication objects specifically enabled for this purpose.

MINiBOX 40 v2 can implement **up to 10 different and independent functions**, each of them entirely customisable and consisting in **up to 4 consecutive operations each**.

The execution of each function can depend on a configurable **condition**, which will be evaluated every time the function is **triggered** through specific, parameterisable communication objects. The result after executing the operations of the function can also be evaluated according to certain **conditions** and afterwards sent (or not) to the KNX bus, which can be done every time the function is executed, periodically or only when the result differs from the last one.

Please refer to the “**Logic Functions**” user manual, available within the MINiBOX 40 v2 product section at the Zennio homepage, www.zennio.com, for detailed information about the functionality and the configuration of the related parameters.

2.4 SCENE TEMPORISATION

The scene temporisation allows imposing **delays over the scenes of the outputs**. These delays are defined in parameters, and can be applied to the execution of one or more scenes that may have been configured.

Please bear in mind that, as multiple delayed scenes can be configured for each individual output / shutter channel / fan coil module, in case of receiving an order to execute one of them when a previous temporisation is still pending for that output / channel / module, such temporisation will be interrupted and only the delay and the action of the new scene will be executed.

ETS PARAMETERISATION

Prior to setting the **scene temporisation**, it is necessary to have one or more scenes configured in some of the outputs. When entering the Configuration window under Scene Temporization, all configured scenes will be listed, together with a few checkboxes to select which of them need to be temporised, as shown in Figure 5.

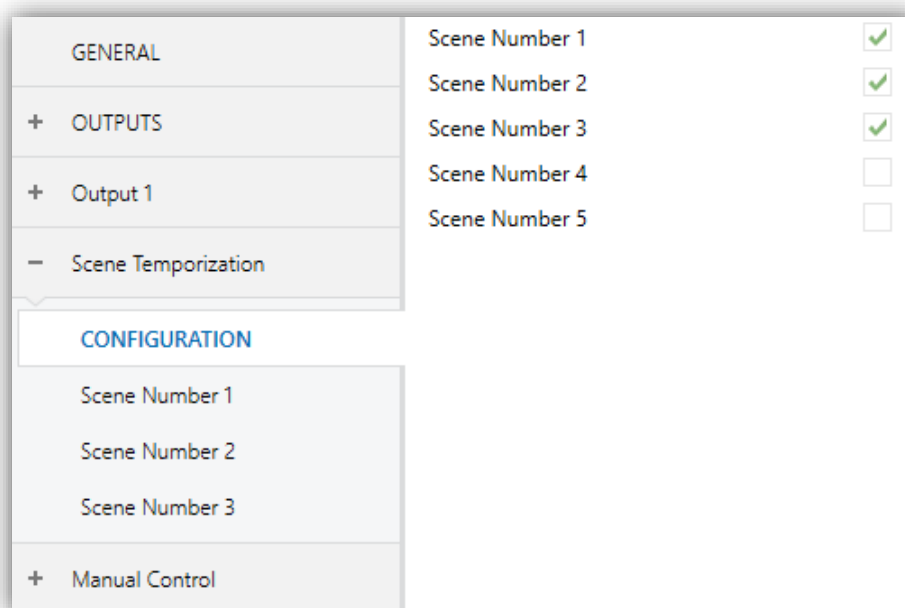

Figure 5. Scene temporisation

Enabling a certain scene number n brings a new tab with such name to the menu on the left, from which it is possible to configure the temporisation of that scene for each of the outputs where it has been configured.

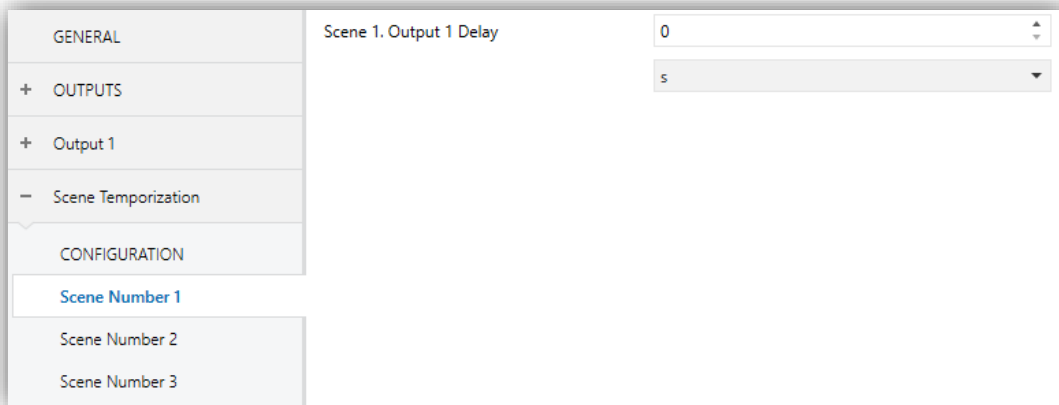

Figure 6. Configuration of the scene temporisation

Therefore, parameter “**Scene m. Z Delay**” [$0\dots3600$ [s] / $0\dots1440$ [min] / $0\dots24$ [h]], defines the delay that will be applied to the action defined in Z for the execution of scene m (where Z may be a specific individual output, shutter channel or fan coil module).

Note: *In the configuration of a scene of an output / shutter channel / fancoil it is possible to parameterize several scenes with the same scene number. This means that several delay parameters associated with the same output appear in the configuration tab of the delays of that scene. With this parameterization, the behavior will be as follows: the action and delay of the first scene parameterized with the same scene number will always prevail, where the highest priority scene is 1 (the first in the scene configuration tab) and the lowest priority is the last.*

2.5 MANUAL CONTROL

MINiBOX 40 v2 allows manually switching the state of its output relays through the respective pushbuttons on the top of the device. A specific pushbutton is therefore available per output.

Manual operation can be done in two different ways, named as **Test On mode** (for testing purposes during the configuration of the device) and **Test Off mode** (for a normal use, anytime). Whether both, only one, or none of these modes should be accessible needs to be parameterised in ETS. Moreover, it is possible to enable a specific binary object for locking and unlocking the manual control in runtime.

Notes:

- *The **Test Off mode** will be active (unless it has been disabled by parameter) after a download or a reset with no need of a specific activation – the pushbuttons will respond to user presses from the start.*
- *On the contrary, switching to the **Test On mode** (unless disabled by parameter) needs to be done by long-pressing the Prog/Test button (for at least three seconds), until the LED is no longer red and turns yellow. From that moment, once the button is released, the LED light will remain green to confirm that the device has switched from the Test Off mode to the Test On mode. After that, an additional press will turn the LED yellow and then off, once the button is released. This way, the device leaves the Test On mode. Note that it will also leave this mode if a bus power failure takes place or if a manual control lock is sending from KNX bus.*

Test Off Mode



Under the Test Off Mode, the outputs can be controlled through both their communication objects and the actual pushbuttons located on the top of the device.

When one of these buttons is pressed, the output will behave as if an order had been received through the corresponding communication object, depending on whether the output is configured as either an individual output, as a shutter channel or as a fan coil.

- **Individual output:** a simple press (short or long) will make the output switch

its on-off state, which will be reported to the KNX bus through the corresponding status object, if enabled.

- **Shutter Channel:** when the button is pressed, the device will act over the output according to the length of the button press and to the current state.
 - A **long press** makes the shutter start moving (upwards or downwards, depending on the button being pressed). The LED will light in green until the end of the motion. If the button gets pressed being the shutter already at the top or bottom positions, nothing will happen (the LED will not light).
 - A **short press** will make the shutter drive stop (if in motion), as it normally does when a step/stop order is received from the KNX bus. In case of not being the shutter in motion, pressing the button does not cause any action, unless slats/lamellas have been parameterized – in such case, a step movement (up/down, depending on the button pressed) will take place. The status objects will be sent to the bus when corresponding.

- **Fan Coil module:** the behaviour will depend on whether a fan-labelled  or a valve-labelled  button is pressed:
 - **Fan:** for this type of buttons, it must be taken into account that there are two types of control for the fan speed:
 - **Switching control:** a short or long press will switch the relays to set the selected speed, unless it matches the current speed – in such case all the relays will be opened (speed 0). The associated LEDs will indicate the state of the fan speed control relays (on = relay closed; off = relay open).
 - **Accumulation control:** a short or long press switch to the selected speed, closing the relay associated with that speed, and also the relays assigned to the lower speeds, unless it matches the current speed – in such case all the relays will be opened (speed 0). The associated LEDs will indicate the state of the fan speed control relays (on = relay closed; off = relay open).

Note: *the behaviour of the relays will depend on the parameterisation, i.e., on the **number of fan speeds**, and on the **delay** between switches.*

- **Valve:** a short or long press will switch the current status of the relay and therefore of the valve. The LED will show the state of the relay anytime (on = relay closed; off = relay open).
- **Disabled output:** outputs disabled by parameter will not react to button presses under the Test Off mode.

Regarding the lock, timer, alarm and scene functions, the device will behave under the Test Off mode as usual. Button presses during this mode are entirely analogous to the reception of the corresponding orders from the KNX bus.

Test On Mode

After entering the Test On mode, it will only be possible to control the outputs through the on-board pushbuttons. Orders received through communication objects will be ignored, with independence of the channel or the output they are addressed to.

Depending on whether the output has been parameterized as an individual output or as part of a shutter channel, the reactions to the button presses will differ.

- **Individual output:** short or long pressing the button will commute the on-off state of the relay.
- **Shutter channel:** pressing the button will make the shutter drive move upward or downward (depending on the button) until the button is released again, thus ignoring the position of the shutter and the parameterized times. For safety reasons, only one closed relay per shutter channel is allowed.

Note: *after leaving the Test On mode, the status objects will recover the values they had prior to entering Test On. As the device is never aware of the actual position of the shutter (as the shutter drive does not provide any feedback), these values may not show the real position. This can be solved by performing a complete move-up or move-down order, or by calibrating the shutter position in the Test On mode until it matches the status objects.*

- **Fan Coil module:** the behaviour is similar to that of the Test Off mode, although in this case the three fan speeds are supposed available.

- **Disabled output:** short and long presses will switch the state of the corresponding relay. In case this consists in closing the relay, then the remaining relays of its block will open, for safety reasons.

As described previously if the device is in Test On mode, any command sent from the KNX bus to the actuator will not affect the outputs and no status objects will be sent (only periodically timed objects such as Heartbeat or logic functions will continue to be sent to the bus) while Test ON mode is active. However, in the case of the "Alarm" and "Block" objects, although in Test ON mode the actions received by each object are not taken into account, the evaluation of their status is carried out when exiting this mode, so that any change in the alarm status or blocking of the outputs while Test ON mode is active is taken into account when exiting this mode and is updated with the last status detected.

Important: *the device is delivered from factory with all the outputs disabled, and with both manual modes (Test Off and Test On) enabled.*

ETS PARAMETERISATION

The **Manual Control** is configured from the Configuration tab itself under Manual Control.

The only two parameters are:

Manual Control	Test Off Mode + Test On Mode
Manual Control Lock	<input checked="" type="checkbox"/>
Value	<input type="radio"/> 0 = Lock; 1 = Unlock <input checked="" type="radio"/> 0 = Unlock; 1 = Lock
Initialization	Last Value

Figure 7. Manual Control

- **Manual Control** [*Disabled / Only Test Off Mode / Only Test On Mode / [Test Off Mode + Test On Mode](#)*]. Depending on the selection, the device will permit using the manual control under the Test Off, the Test On, or both modes. Note that, as stated before, using the Test Off mode does not require any

special action, while switching to the Test On mode does require long-pressing the Prog/Test button.

- **Manual Control Lock** [*enabled/disabled*]: unless the above parameter has been “Disabled”, the Lock Manual Control parameter provides an optional procedure for locking the manual control in runtime. When this checkbox is enabled, object “**Manual Control Lock**” turns visible, as well as two more parameters:
 - **Value** [*0 = Lock; 1 = Unlock / 0 = Unlock; 1 = Lock*]: defines whether the manual control lock/unlock should take place respectively upon the reception (through the aforementioned object) of values “0” and “1”, or the opposite.
 - **Initialization** [*Unlocked / Locked / Last Value*]: sets how the lock state of the manual control should remain after the device start-up (after an ETS download or a bus power failure). “Last Value” (default; on the very first start-up, this will be Unlocked).

ANNEX I. COMMUNICATION OBJECTS

- “**Functional range**” shows the values that, with independence of any other values permitted by the bus according to the object size, may be of any use or have a particular meaning because of the specifications or restrictions from both the KNX standard or the application programme itself.

Number	Size	I/O	Flags	Data type (DPT)	Functional Range	Name	Function
1	1 Bit		CT---	DPT_Trigger	0/1	Reset 0	Voltage Recovery -> Sending of 0
2	1 Bit		CT---	DPT_Trigger	0/1	Reset 1	Voltage Recovery -> Sending of 1
3	1 Bit	I	C--W-	DPT_Enable	0/1	Lock Manual Control	0 = Lock; 1 = Unlock
	1 Bit	I	C--W-	DPT_Enable	0/1	Lock Manual Control	0 = Unlock; 1 = Lock
4	1 Bit		CT---	DPT_Trigger	0/1	[Heartbeat] Object to Send '1'	Sending of '1' Periodically
5, 16, 27, 38, 49, 60, 71, 82, 93, 104, 115, 126, 137, 148, 159, 170, 181, 192, 203, 214, 225, 236, 247, 258	1 Byte	I	C--W-	DPT_SceneControl	0-63; 128-191	[Ox] Scenes	0 - 63 (Execute 1 - 64); 128 - 191 (Save 1 - 64)
6, 17, 28, 39, 50, 61, 72, 83, 94, 105, 116, 127, 138, 149, 160, 171, 182, 193, 204, 215, 226, 237, 248, 259	1 Bit	I	C--W-	DPT_BinaryValue	0/1	[Ox] On/Off	N.O. (0=Open Relay; 1=Close Relay)
	1 Bit	I	C--W-	DPT_BinaryValue	0/1	[Ox] On/Off	N.C. (0=Close Relay; 1= Open Relay)
7, 18, 29, 40, 51, 62, 73, 84, 95, 106, 117, 128, 139, 150, 161, 172, 183, 194, 205, 216, 227, 238, 249, 260	1 Bit	O	CTR--	DPT_BinaryValue	0/1	[Ox] On/Off (Status)	0=Output Off; 1=Output On
8, 19, 30, 41, 52, 63, 74, 85, 96, 107, 118, 129, 140, 151, 162, 173, 184, 195, 206, 217, 228, 239, 250, 261	1 Bit	I	C--W-	DPT_Enable	0/1	[Ox] Lock	0=Unlock; 1=Lock
9, 20, 31, 42, 53, 64, 75, 86, 97, 108, 119, 130, 141, 152, 163, 174, 185, 196, 207, 218, 229, 240, 251, 262	1 Bit	I	C--W-	DPT_Start	0/1	[Ox] Timer	0=Switch Off; 1=Switch On
10, 21, 32, 43, 54, 65, 76, 87, 98, 109, 120, 131, 142, 153, 164, 175, 186, 197, 208, 219, 230, 241, 252, 263	1 Bit	I	C--W-	DPT_Start	0/1	[Ox] Flashing	0=Stop; 1=Start
11, 22, 33, 44, 55, 66, 77, 88,	1 Bit	I	C--W-	DPT_Alarm	0/1	[Ox] Alarm	0=Normal; 1=Alarm

99, 110, 121, 132, 143, 154, 165, 176, 187, 198, 209, 220, 231, 242, 253, 264	1 Bit	I	C--W-	DPT_Alarm	0/1	[Ox] Alarm	0=Alarm; 1=Normal
12, 23, 34, 45, 56, 67, 78, 89, 100, 111, 122, 133, 144, 155, 166, 177, 188, 199, 210, 221, 232, 243, 254, 265	1 Bit	I	C--W-	DPT_Ack	0/1	[Ox] Unfreeze Alarm	Alarm=0 + Unfreeze=1 => End Alarm
13, 24, 35, 46, 57, 68, 79, 90, 101, 112, 123, 134, 145, 156, 167, 178, 189, 200, 211, 222, 233, 244, 255, 266	1 Bit	O	CTR--	DPT_State	0/1	[Ox] Warning Time (Status)	0=Normal; 1=Warning
14, 25, 36, 47, 58, 69, 80, 91, 102, 113, 124, 135, 146, 157, 168, 179, 190, 201, 212, 223, 234, 245, 256, 267	4 Bytes	I/O	CTRW-	DPT_LongDeltaTimeSec	-2147483648, 2147483647	[Ox] Operating Time (s)	Time in Seconds
15, 26, 37, 48, 59, 70, 81, 92, 103, 114, 125, 136, 147, 158, 169, 180, 191, 202, 213, 224, 235, 246, 257, 268	2 Bytes	I/O	CTRW-	DPT_TimePeriodHrs	0 - 65535	[Ox] Operating Time (h)	Time in Hours
269	1 Byte	I	C--W-	DPT_SceneControl	0-63; 128-191	[Shutter] Scenes	0 - 63 (Execute 1 - 64); 128 - 191 (Save 1 - 64)
270, 298, 326, 354, 382, 410, 438, 466, 494, 522, 550, 578	1 Bit	I	C--W-	DPT_UpDown	0/1	[Cx] Move	0=Raise; 1=Lower
271, 299, 327, 355, 383, 411, 439, 467, 495, 523, 551, 579	1 Bit	I	C--W-	DPT_Step	0/1	[Cx] Stop/Step	0=Stop/StepUp; 1=Stop/StepDown
	1 Bit	I	C--W-	DPT_Trigger	0/1	[Cx] Stop	0=Stop; 1=Stop
272, 300, 328, 356, 384, 412, 440, 468, 496, 524, 552, 580	1 Bit	I	C--W-	DPT_Enable	0/1	[Cx] Lock	0=Unlock; 1=Lock
273, 301, 329, 357, 385, 413, 441, 469, 497, 525, 553, 581	1 Byte	I	C--W-	DPT_Scaling	0% - 100%	[Cx] Shutter Positioning	0%=Top; 100%=Bottom
274, 302, 330, 358, 386, 414, 442, 470, 498, 526, 554, 582	1 Byte	O	CTR--	DPT_Scaling	0% - 100%	[Cx] Shutter Position (Status)	0%=Top; 100%=Bottom
275, 303, 331, 359, 387, 415, 443, 471, 499, 527, 555, 583	1 Byte	I	C--W-	DPT_Scaling	0% - 100%	[Cx] Slats Positioning	0%=Open; 100%=Closed
276, 304, 332, 360, 388, 416, 444, 472, 500, 528, 556, 584	1 Byte	O	CTR--	DPT_Scaling	0% - 100%	[Cx] Slats Position (Status)	0%=Open; 100%=Closed
277, 305, 333, 361, 389, 417, 445, 473, 501, 529, 557, 585	1 Bit	O	CTR--	DPT_Switch	0/1	[Cx] Rising Relay (Status)	0=Open; 1=Closed
278, 306, 334, 362, 390, 418, 446, 474, 502, 530, 558, 586	1 Bit	O	CTR--	DPT_Switch	0/1	[Cx] Lowering Relay (Status)	0=Open; 1=Closed
279, 307, 335, 363, 391, 419, 447, 475, 503, 531, 559, 587	1 Bit	O	CTR--	DPT_Switch	0/1	[Cx] Movement (Status)	0=Stopped; 1=Moving
280, 308, 336, 364, 392, 420,	1 Bit	O	CTR--	DPT_UpDown	0/1	[Cx] Movement Direction (Status)	0=Upward; 1=Downward

448, 476, 504, 532, 560, 588							
281, 309, 337, 365, 393, 421, 449, 477, 505, 533, 561, 589	1 Bit	I	C - - W -	DPT_Switch	0/1	[Cx] Auto: On/Off	0=On; 1=Off
	1 Bit	I	C - - W -	DPT_Switch	0/1	[Cx] Auto: On/Off	0=Off; 1=On
282, 310, 338, 366, 394, 422, 450, 478, 506, 534, 562, 590	1 Bit	O	CTR - -	DPT_Switch	0/1	[Cx] Auto: On/Off (Status)	0=On; 1=Off
	1 Bit	O	CTR - -	DPT_Switch	0/1	[Cx] Auto: On/Off (Status)	0=Off; 1=On
283, 311, 339, 367, 395, 423, 451, 479, 507, 535, 563, 591	1 Bit	I	C - - W -	DPT_UpDown	0/1	[Cx] Auto: Move	0=Raise; 1=Lower
284, 312, 340, 368, 396, 424, 452, 480, 508, 536, 564, 592	1 Bit	I	C - - W -	DPT_Step	0/1	[Cx] Auto: Stop/Step	0=Stop/StepUp; 1=Stop/StepDown
	1 Bit	I	C - - W -	DPT_Step	0/1	[Cx] Auto: Stop	0=Stop; 1=Stop
285, 313, 341, 369, 397, 425, 453, 481, 509, 537, 565, 593	1 Byte	I	C - - W -	DPT_Scaling	0% - 100%	[Cx] Auto: Shutter Positioning	0%=Top; 100%=Bottom
286, 314, 342, 370, 398, 426, 454, 482, 510, 538, 566, 594	1 Byte	I	C - - W -	DPT_Scaling	0% - 100%	[Cx] Auto: Slats Positioning	0%=Open; 100%=Closed
287, 315, 343, 371, 399, 427, 455, 483, 511, 539, 567, 595	1 Bit	I	CT - W U	DPT_Scene_AB	0/1	[Cx] Sunshine/Shadow	0=Sunshine; 1=Shadow
	1 Bit	I	CT - W U	DPT_Scene_AB	0/1	[Cx] Sunshine/Shadow	0=Shadow; 1=Sunshine
288, 316, 344, 372, 400, 428, 456, 484, 512, 540, 568, 596	1 Bit	I	CT - W U	DPT_Heat_Cool	0/1	[Cx] Cooling/Heating	0=Heating; 1=Cooling
	1 Bit	I	CT - W U	DPT_Heat_Cool	0/1	[Cx] Cooling/Heating	0=Cooling; 1=Heating
289, 317, 345, 373, 401, 429, 457, 485, 513, 541, 569, 597	1 Bit	I	CT - W U	DPT_Occupancy	0/1	[Cx] Presence/No Presence	0=Presence; 1=No Presence
	1 Bit	I	CT - W U	DPT_Occupancy	0/1	[Cx] Presence/No Presence	0=No Presence; 1=Presence
290, 318, 346, 374, 402, 430, 458, 486, 514, 542, 570, 598	1 Bit	I	C - - W -	DPT_Alarm	0/1	[Cx] Alarm 1	0=No Alarm; 1=Alarm
	1 Bit	I	C - - W -	DPT_Alarm	0/1	[Cx] Alarm 1	0=Alarm; 1=No Alarm
291, 319, 347, 375, 403, 431, 459, 487, 515, 543, 571, 599	1 Bit	I	C - - W -	DPT_Alarm	0/1	[Cx] Alarm 2	0=No Alarm; 1=Alarm
	1 Bit	I	C - - W -	DPT_Alarm	0/1	[Cx] Alarm 2	0=Alarm; 1=No Alarm
292, 320, 348, 376, 404, 432, 460, 488, 516, 544, 572, 600	1 Bit	I	C - - W -	DPT_Ack	0/1	[Cx] Unfreeze Alarm	Alarm1=Alarm2=No Alarm + Unfreeze (1) => End Alarm
293, 321, 349, 377, 405, 433, 461, 489, 517, 545, 573, 601	1 Bit	I	C - - W -	DPT_Scene_AB	0/1	[Cx] Move (Reversed)	0=Lower; 1=Raise
294, 322, 350, 378, 406, 434, 462, 490, 518, 546, 574, 602	1 Bit	I	C - - W -	DPT_Ack	0/1	[Cx] Direct Positioning 1	0=No Action; 1=Go to Position
295, 323, 351, 379, 407, 435, 463, 491, 519, 547, 575, 603	1 Bit	I	C - - W -	DPT_Ack	0/1	[Cx] Direct Positioning 2	0=No Action; 1=Go to Position
296, 324, 352, 380, 408, 436, 464, 492, 520, 548, 576, 604	1 Bit	I	C - - W -	DPT_Ack	0/1	[Cx] Direct Positioning 1 (Save)	0=No Action; 1=Save Current Position
297, 325, 353, 381, 409, 437, 465, 493, 521, 549, 577, 605	1 Bit	I	C - - W -	DPT_Ack	0/1	[Cx] Direct Positioning 2 (Save)	0=No Action; 1=Save Current Position
606	1 Byte	I	C - - W U	DPT_SceneControl	0-63; 128-191	[Fan Coil] Scenes	0 - 63 (Execute 1 - 64); 128 - 191 (Save 1 - 64)
607, 640, 673, 706, 739, 772	1 Bit	I	C - - W U	DPT_Switch	0/1	[FCx] On/Off	0 = Off; 1 = On
608, 641, 674, 707, 740, 773	1 Bit	O	CTR - -	DPT_Switch	0/1	[FCx] On/Off (Status)	0 = Off; 1 = On

609, 642, 675, 708, 741, 774	1 Bit	I	C--WU	DPT_Heat_Cool	0/1	[FCx] Mode	0 = Cool; 1 = Heat
610, 643, 676, 709, 742, 775	1 Bit	O	CTR--	DPT_Heat_Cool	0/1	[FCx] Mode (Status)	0 = Cool; 1 = Heat
611, 644, 677, 710, 743, 776	1 Bit	I	C--WU	DPT_Switch	0/1	[FCx] Fan: Manual/Automatic	0 = Automatic; 1 = Manual
	1 Bit	I	C--WU	DPT_Switch	0/1	[FCx] Fan: Manual/Automatic	0 = Manual; 1 = Automatic
612, 645, 678, 711, 744, 777	1 Bit	O	CTR--	DPT_Switch	0/1	[FCx] Fan: Manual/Automatic (Status)	0 = Automatic; 1 = Manual
	1 Bit	O	CTR--	DPT_Switch	0/1	[FCx] Fan: Manual/Automatic (Status)	0 = Manual; 1 = Automatic
613, 646, 679, 712, 745, 778	1 Bit	I	C--WU	DPT_Step	0/1	[FCx] Manual Fan: Step Control	0 = Down; 1 = Up
614, 647, 680, 713, 746, 779	1 Bit	I	C--WU	DPT_Switch	0/1	[FCx] Manual Fan: Speed 0	0 = Off; 1 = On
615, 648, 681, 714, 747, 780	1 Bit	I	C--WU	DPT_Switch	0/1	[FCx] Manual Fan: Speed 1	0 = Off; 1 = On
616, 649, 682, 715, 748, 781	1 Bit	I	C--WU	DPT_Switch	0/1	[FCx] Manual Fan: Speed 2	0 = Off; 1 = On
617, 650, 683, 716, 749, 782	1 Bit	I	C--WU	DPT_Switch	0/1	[FCx] Manual Fan: Speed 3	0 = Off; 1 = On
618, 651, 684, 717, 750, 783	1 Bit	O	CTR--	DPT_Switch	0/1	[FCx] Fan: Speed 0 (Status)	0 = Off; 1 = On
619, 652, 685, 718, 751, 784	1 Bit	O	CTR--	DPT_Switch	0/1	[FCx] Fan: Speed 1 (Status)	0 = Off; 1 = On
620, 653, 686, 719, 752, 785	1 Bit	O	CTR--	DPT_Switch	0/1	[FCx] Fan: Speed 2 (Status)	0 = Off; 1 = On
621, 654, 687, 720, 753, 786	1 Bit	O	CTR--	DPT_Switch	0/1	[FCx] Fan: Speed 3 (Status)	0 = Off; 1 = On
622, 655, 688, 721, 754, 787	1 Byte	I	C--WU	DPT_Value_1_Ucount	0 - 255	[FCx] Manual Fan: Enumeration Control	S0 = 0; S1 = 1; S2 = 2; S3 = 3
	1 Byte	I	C--WU	DPT_Value_1_Ucount	0 - 255	[FCx] Manual Fan: Enumeration Control	S0 = 0; S1 = 1; S2 = 2
	1 Byte	I	C--WU	DPT_Value_1_Ucount	0 - 255	[FCx] Manual Fan: Enumeration Control	S0 = 0; S1 = 1
623, 656, 689, 722, 755, 788	1 Byte	O	CTR--	DPT_Value_1_Ucount	0 - 255	[FCx] Fan: Speed Enumeration (Status)	S0 = 0; S1 = 1; S2 = 2; S3 = 3
	1 Byte	O	CTR--	DPT_Value_1_Ucount	0 - 255	[FCx] Fan: Speed Enumeration (Status)	S0 = 0; S1 = 1; S2 = 2
	1 Byte	O	CTR--	DPT_Value_1_Ucount	0 - 255	[FCx] Fan: Speed Enumeration (Status)	S0 = 0; S1 = 1
624, 657, 690, 723, 756, 789	1 Byte	I	C--WU	DPT_Scaling	0% - 100%	[FCx] Manual Fan: Percentage Control	S0 = 0%; S1 = 0,4-33,3%; S2 = 33,7-66,7%; S3 = 67,1-100%
	1 Byte	I	C--WU	DPT_Scaling	0% - 100%	[FCx] Manual Fan: Percentage Control	S0 = 0%; S1 = 1-50%; S2 = 51-100%
	1 Byte	I	C--WU	DPT_Scaling	0% - 100%	[FCx] Manual Fan: Percentage Control	S0 = 0%; S1 = 1-100%
625, 658, 691, 724, 757, 790	1 Byte	O	CTR--	DPT_Scaling	0% - 100%	[FCx] Fan: Speed Percentage (Status)	S0 = 0%; S1 = 33,3%; S2 = 66,6%; S3 = 100%
	1 Byte	O	CTR--	DPT_Scaling	0% - 100%	[FCx] Fan: Speed Percentage (Status)	S0 = 0%; S1 = 1-50%; S2 = 51-100%
	1 Byte	O	CTR--	DPT_Scaling	0% - 100%	[FCx] Fan: Speed Percentage (Status)	S0 = 0%; S1 = 1-100%
626, 659, 692, 725, 758, 791	1 Byte	I	C--WU	DPT_Scaling	0% - 100%	[FCx] Cooling Fan: Continuous Control	0 - 100%
	1 Byte	I	C--WU	DPT_Scaling	0% - 100%	[FCx] Cooling Valve: PI Control (Continuous)	0 - 100%
627, 660, 693, 726, 759, 792	1 Byte	I	C--WU	DPT_Scaling	0% - 100%	[FCx] Heating Fan: Continuous Control	0 - 100%

	1 Byte	I	C--WU	DPT_Scaling	0% - 100%	[FCx] Heating Valve: PI Control (Continuous)	0 - 100%
628, 661, 694, 727, 760, 793	1 Bit	I	C--WU	DPT_OpenClose	0/1	[FCx] Cooling Valve: Control Variable (1 bit)	0 = Open Valve; 1 = Close Valve
	1 Bit	I	C--WU	DPT_Switch	0/1	[FCx] Cooling Valve: Control Variable (1 bit)	0 = Close Valve; 1 = Open Valve
629, 662, 695, 728, 761, 794	1 Bit	I	C--WU	DPT_OpenClose	0/1	[FCx] Heating Valve: Control Variable (1 bit)	0 = Open Valve; 1 = Close Valve
	1 Bit	I	C--WU	DPT_Switch	0/1	[FCx] Heating Valve: Control Variable (1 bit)	0 = Close Valve; 1 = Open Valve
630, 663, 696, 729, 762, 795	1 Bit	O	CTR--	DPT_OpenClose	0/1	[FCx] Cooling Valve (Status)	0 = Open; 1 = Closed
	1 Bit	O	CTR--	DPT_Switch	0/1	[FCx] Cooling Valve (Status)	0 = Closed; 1 = Open
	1 Bit	O	CTR--	DPT_OpenClose	0/1	[FCx] Valve (Status)	0 = Open; 1 = Closed
	1 Bit	O	CTR--	DPT_Switch	0/1	[FCx] Valve (Status)	0 = Closed; 1 = Open
631, 664, 697, 730, 763, 796	1 Bit	O	CTR--	DPT_OpenClose	0/1	[FCx] Heating Valve (Status)	0 = Open; 1 = Closed
	1 Bit	O	CTR--	DPT_Switch	0/1	[FCx] Heating Valve (Status)	0 = Closed; 1 = Open
632, 665, 698, 731, 764, 797	1 Bit	O	CTR--	DPT_Switch	0/1	[FCx] Cooling Valve: Anti-Seize Protection (Status)	0 = Not Active; 1 = Active
	1 Bit	O	CTR--	DPT_Switch	0/1	[FCx] Valve: Anti-Seize Protection (Status)	0 = Not Active; 1 = Active
633, 666, 699, 732, 765, 798	1 Bit	O	CTR--	DPT_Switch	0/1	[FCx] Heating Valve: Anti-Seize Protection (Status)	0 = Not Active; 1 = Active
634, 667, 700, 733, 766, 799	1 Byte	O	CTR--	DPT_Scaling	0% - 100%	[FCx] Valve (Status)	0 - 100%
	1 Byte	O	CTR--	DPT_Scaling	0% - 100%	[FCx] Cooling Valve (Status)	0 - 100%
635, 668, 701, 734, 767, 800	1 Byte	O	CTR--	DPT_Scaling	0% - 100%	[FCx] Heating Valve (Status)	0 - 100%
636, 669, 702, 735, 768, 801	1 Bit	O	CTR--	DPT_Bool	0/1	[FCx] Control Value - Error	0 = No Error; 1 = Error
637, 670, 703, 736, 769, 802	2 Bytes	I	C--WU	DPT_Value_Temp	-273.00° - 670760.00°	[FCx] Ambient Temperature	Ambient Temperature
638, 671, 704, 737, 770, 803	2 Bytes	I	C--WU	DPT_Value_Temp	-273.00° - 670760.00°	[FCx] Setpoint Temperature	Setpoint Temperature
639, 672, 705, 738, 771, 804	2 Bytes	I/O	CTRWU	DPT_TimePeriodMin	0 - 65535	[FCx] Duration of Manual Control	0 = Endless; 1 - 1440 min
	2 Bytes	I/O	CTRWU	DPT_TimePeriodHrs	0 - 65535	[FCx] Duration of Manual Control	0 = Endless; 1 - 24 h
805, 806, 807, 808, 809, 810, 811, 812, 813, 814, 815, 816, 817, 818, 819, 820, 821, 822, 823, 824, 825, 826, 827, 828, 829, 830, 831, 832, 833, 834, 835, 836, 837, 838, 839, 840,	1 Bit	I	C--W-	DPT_Bool	0/1	[LF] (1-Bit) Data Entry x	Binary Data Entry (0/1)

841, 842, 843, 844, 845, 846, 847, 848, 849, 850, 851, 852, 853, 854, 855, 856, 857, 858, 859, 860, 861, 862, 863, 864, 865, 866, 867, 868							
869, 870, 871, 872, 873, 874, 875, 876, 877, 878, 879, 880, 881, 882, 883, 884, 885, 886, 887, 888, 889, 890, 891, 892, 893, 894, 895, 896, 897, 898, 899, 900	1 Byte	I	C--W-	DPT_Value_1_Ucount	0 - 255	[LF] (1-Byte) Data Entry x	1-Byte Data Entry (0-255)
901, 902, 903, 904, 905, 906, 907, 908, 909, 910, 911, 912, 913, 914, 915, 916, 917, 918, 919, 920, 921, 922, 923, 924, 925, 926, 927, 928, 929, 930, 931, 932	2 Bytes	I	C--W-	DPT_Value_2_Ucount	0 - 65535	[LF] (2-Byte) Data Entry x	2-Byte Data Entry
				DPT_Value_2_Count	-32768 -32767		
				DPT_Value_Tempo	-273,00 - 670760,00		
933, 934, 935, 936, 937, 938, 939, 940, 941, 942, 943, 944, 945, 946, 947, 948	4 Bytes	I	C--W-	DPT_Value_4_Count	-2147483648 - 2147483647	[LF] (4-Byte) Data Entry x	4-Byte Data Entry
949, 950, 951, 952, 953, 954, 955, 956, 957, 958, 959, 960, 961, 962, 963, 964, 965, 966, 967, 968, 969, 970, 971, 972, 973, 974, 975, 976, 977, 978	1 Bit	O	CTR--	DPT_Bool	0/1	[LF] Function x - Result	(1-Bit) Boolean
	1 Byte	O	CTR--	DPT_Value_1_Ucount	0 - 255	[LF] Function x - Result	(1-Byte) Unsigned
	2 Bytes	O	CTR--	DPT_Value_2_Ucount	0 - 65535	[LF] Function x - Result	(2-Byte) Unsigned
	4 Bytes	O	CTR--	DPT_Value_4_Count	-2147483648 - 2147483647	[LF] Function x - Result	(4-Byte) Signed
	1 Byte	O	CTR--	DPT_Scaling	0% - 100%	[LF] Function x - Result	(1-Byte) Percentage
	2 Bytes	O	CTR--	DPT_Value_2_Count	-32768 - 32767	[LF] Function x - Result	(2-Byte) Signed
	2 Bytes	O	CTR--	DPT_Value_Temp	-273.00° - 670760.00°	[LF] Function x - Result	(2-Byte) Float
979, 981, 983, 985, 987, 989, 991, 993, 995, 997, 999, 1001, 1003, 1005, 1007, 1009, 1011, 1013, 1015, 1017, 1019, 1021, 1023, 1025	4 Bytes	O	CTR--	DPT_Value_4_Ucount	0 - 4294967295	[Relay x] Number of Switches	Number of Switches
980, 982, 984, 986, 988, 990, 992, 994, 996, 998, 1000, 1002, 1004, 1006, 1008, 1010, 1012, 1014, 1016, 1018, 1020, 1022, 1024, 1026	2 Bytes	O	CTR--	DPT_Value_2_Ucount	0 - 65535	[Relay x] Maximum Switches per Minute	Maximum Switches per Minute

Join and send us your inquiries
about Zennio devices:

<http://support.zennio.com>

Zennio Avance y Tecnología S.L.
C/ Río Jarama, 132. Nave P-8.11
45007 Toledo (Spain).

Tel. +34 925 232 002

www.zennio.com
info@zennio.com



RoHS