

Switch actuator REG-K/2x230/16 with manual mode

Operating instructions

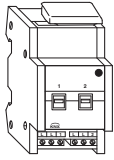

Art. no. MTN647393

For your safety



DANGER

Risk of fatal injury from electrical current.

The device may only be installed and connected by trained electricians. Observe the country-specific regulations as well as the valid KNX guidelines.



CAUTION

The device could be damaged.

- Only operate the device according to the specifications stated in the Technical data.
- All devices that are installed next to the actuator must be equipped with at least basic insulation.

Getting to know the switch actuator

The switch actuator REG-K/2x230/16 with manual mode (referred to below as the **actuator**) can switch two loads via separate, floating make contacts.

You can also manually switch the connected loads with manual switches on the actuator without bus voltage.

The actuator has a bus coupler. It is installed on a DIN rail, with the bus connection made via a bus connecting terminal. It is supplied with power from the bus voltage. A data rail is not required.

Connections, displays and operating elements

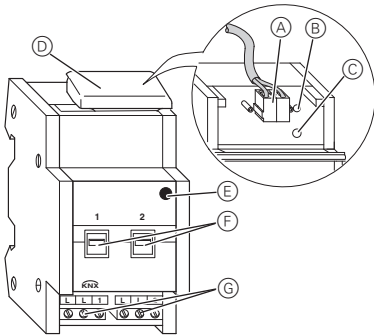

- (A) Bus connecting terminal, max. 4 core pairs
- (B) Programming LED (red LED)
- (C) Programming button
- (D) Cable cover
- (E) Operating LED (green LED)
- (F) Manual switch
- (G) Screw terminals

Mounting the actuator

- Set the actuator onto the DIN rail.

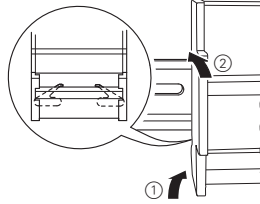

- Connect KNX.

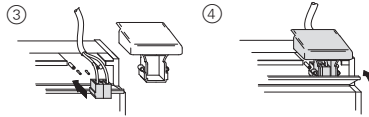
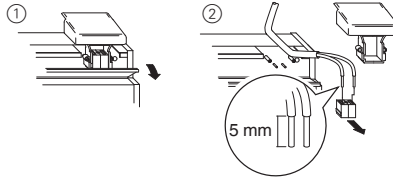

WARNING

Risk of fatal injury from electrical current. The device could become damaged.

Safety clearance must be guaranteed in accordance with IEC 60664-1. There must be at least 4 mm between the individual cores of the 230 V supply cable and the KNX line.

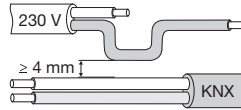

DANGER

Risk of fatal injury from electrical current.

Voltage may be present at the outputs when the mains voltage is connected to the system. If subjected to strong vibrations during transportation, the switch contacts might change to the enabled state. After connecting the bus voltage, set the relays of the channels to the position desired simply by switching "On/Off" or by changing the manual switch to "OFF".

- Connect the bus voltage.
- Wait at least 30 seconds.
- Set the relays of the channels to the position desired simply by switching "On/Off" or by changing the manual switch to "OFF".



CAUTION

The actuator can be damaged.

Protect the switch contacts with a series-connected 16 A circuit breaker.

- Connect the load.

The cables to the loads as well as the system voltages (L1, L2 or L3) are connected via screw terminals for max. 16 A. Every two L connections are bridged internally.

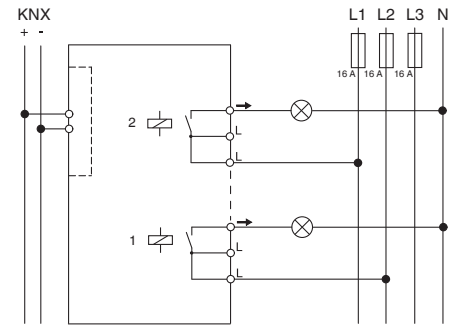

- Connect the mains voltage.

Now you can check the functionality of the actuator and the connected loads without having to load the application from the ETS. (See the "Operating the actuator" section.)

Putting the actuator into operation

- Press the programming button.

The programming LED lights up.

- Load the physical address and application into the device from the ETS.

The programming LED goes out.

The operating LED lights up: The application was loaded successfully, the device is ready for operation.

Operating the actuator

Normally, you control connected devices using push-buttons or by remote control. However, you can manually switch each of the actuator's channels on and off directly at the manual switches.

Technical data

Supply from KNX:	DC 24 V / approx. 12.5 mA
Switch contacts 1 to 2:	2 x make contacts, floating
Nominal voltage:	AC 230 V, 50 to 60 Hz
Nominal current:	16 A, $\cos \varphi = 0.6$
Connected load	
Incandescent lamps:	AC 230 V, max. 3600 W with 10,000 switching cycles
Halogen lamps:	AC 230 V, max. 2500 W with 10,000 switching cycles
Fluorescent lamps:	AC 230 V, max. 2500 VA, parallel-compensated, with 5,000 switching cycles
Capacitive load:	AC 230 V, 16 A max. 200 μ F with 5,000 switching cycles
Switching frequency:	max. 10 per minute at nominal load
Ambient temperature	
Operation:	-5 °C to +45 °C
Storage:	-25 °C to +55 °C
Transport:	-25 °C to +70 °C
Environment:	can be used at up to 2000 m above sea level (MSL)
Max. humidity:	93 %, no moisture condensation
Connections	
Bus:	via two 1 mm pins for bus connecting terminal
Outer conductor:	two 3-gang screw terminals for max. 2.5 mm ²
Device width:	2.5 depth units = approx. 45 mm

Schneider Electric Industries SAS

If you have technical questions, please contact the Customer Care Center in your country.
www.schneider-electric.com

This product must be installed, connected and used in compliance with prevailing standards and/or installation regulations. As standards, specifications and designs develop from time to time, always ask for confirmation of the information given in this publication.

Switch Logic Time Scene Dis. Prio. Init.

4810/1.1

Dynamic administration of group addresses
Maximum no. of group addresses and associations:
104

Device selection:



The application must first be adapted to the hardware in use. When changing over the device selection, parameter settings and linked group addresses are modified by the ETS program. For this reason, the device selection should be set before configuring the device.

Parameters

Device selection	
Parameter	Setting
Device selection	1-gang switch actuator, flush-mounted/230/16
	2-gang switch actuator REG-K/2x230/16 with manual mode
	4-gang switch actuator REG-K/4x230/16 with manual mode
	8-gang switch actuator REG-K/8x230/6

Function

When the application is loaded, the following functions can be implemented and controlled via the bus:

Block diagram:

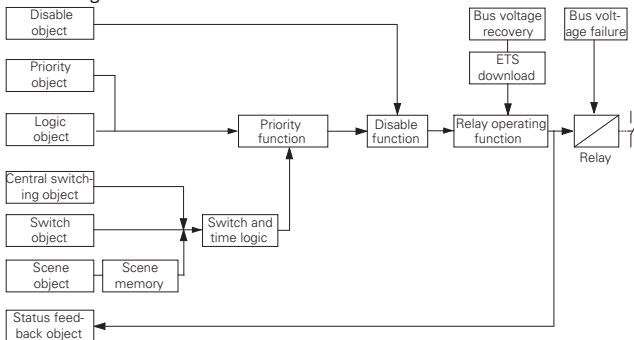

With regard to the switching behaviour of the actuator, each function has a certain priority. The weighting of the functions can be taken from the following table:

Priorities:

Priority	Function
Highest priority	Relay state after bus voltage failure
	Disable function
	Priority function
	Logic operation
Lowest priority	Priority control
	Relay state after bus voltage recovery/ETS download
	Switching, time, central and scene functions

Behaviour on bus voltage failure/reset

● Behaviour on bus voltage failure

When the bus voltage drops below 18 V, the relay can adopt a parameterised state. The relay can either be closed, opened or remain in the position it occupied prior to the failure. At the same time, the current switching position of the relay is stored in the device. Only the actual relay state ("1" for closed; "0" for opened) at the time of the voltage failure is saved and not any active time delays. No further status response telegrams are sent. This function has the highest priority.

Parameters

Channel X: General	
Parameter	Setting
Relay state after bus voltage failure	no change
	opened
	closed

● Behaviour on bus voltage recovery

On bus voltage recovery, the relay can adopt a parameterised state. The following options are available for selection.

In the settings "opened" or "closed", the relay contact is opened or closed. An inversion does not take place in the "break contact" relay mode.

Staircase lighting functions: In the "make contact" mode, the staircase lighting function starts with the setting "closed". This also happens in the "break contact" mode with the setting "opened".

In the setting "no change", the relay remains in the current state. Any manual operation that occurs in the meantime (with 2-gang and 4-gang switch actuators) is retained. The device does not know the status of the channel at this point and therefore no status signal can take place. The status is only available following a switching action of the channel.

In the setting "as for bus voltage failure", the relay adopts the state which was stored in the device on bus voltage failure. Any manual operations that occur (with 2-gang and 4-gang switch actuators) are overwritten. There are no stored states once the application has been downloaded. This means that the

output is opened in the "make contact" mode while the relay closes in the "break contact" mode.

If the setting "flash" is selected, the relay starts to flash on bus voltage recovery. The flashing interval can be set.



Important

No short switching times may be parameterised under load (see the technical data for the switch output)

Before triggering the relay, a check is made to determine whether there is sufficient energy to operate the relay. If there is sufficient energy, the relay immediately switches to the parameterised state. Otherwise there is a delay until sufficient energy is available.



Important:

Relay states that are caused by functions with a higher priority (higher priority function) take precedence over the behaviour after bus voltage recovery.

Example: OR logic operation with parameterised value of the logic object after bus voltage recovery = 1 takes priority and switches the output.

Status response

Each channel can deliver a status response, depending on the parameter settings. An exception is made in the setting "no change": since the current status cannot be reliably determined, no status telegram is sent.

Parameters

Channel X: General	
Parameter	Setting
Relay state after bus voltage recovery	no change
	as for bus voltage failure
	opened
	closed
	flash

If "flash" is selected, the flashing interval must be set.

Flashing interval	
Parameter	Setting
Flashing interval base	100 ms
	1 s
	1 min
	1 hr
Flashing interval factor [5-255]	10 adjustable in single steps

● **Behaviour after ETS download**

After the ETS download, the relay can adopt a parameterised state. The following options are available for selection.

In the settings "opened" or "closed", the relay contact is opened or closed. An inversion does not take place in the "break contact" relay mode.

Staircase lighting functions: In the "make contact" mode, the staircase lighting function starts with the setting "closed". This also happens in the "break contact" mode with the setting "opened".

In the setting "no change", the relay remains in the state it occupied prior to the download. Any manual operation that occurs in the meantime (with 2-gang and 4-gang switch actuators) is not overwritten. This function is conceived for the reconfiguration of switch actuators in occupied buildings so that the outputs do not switch in the event of a download. The device does not know the status of the channel at this point and therefore no status signal can take place. The status is only available following a switching action of the channel.

If the option "as for bus voltage recovery" is selected, the setting for the parameter "Relay state after bus voltage recovery" is adopted.

See: Behaviour on bus voltage recovery

Before triggering the relay, a check is made to determine whether there is sufficient energy to operate the relay. If there is sufficient energy, the relay immediately switches to the parameterised state. Otherwise there is a delay until sufficient energy is available.



Important:

Relay states that are caused by functions with a higher priority (higher priority function) take precedence over the behaviour after ETS download.

Example: OR logic operation with parameterised value of the logic object after bus voltage recovery = 1 takes priority and switches the output.

Status response

Each channel can deliver a status response, depending on the parameter settings. An exception is made in the setting "no change": since the current status cannot be reliably determined, no status telegram is sent.

Parameters

Channel X: General	
Parameter	Setting
Relay state after ETS download	no change
	opened
	closed
	as for bus voltage recovery

Relay operation

The operation mode of the relay can be set via the parameter "Relay operation". The relay can be used as a "break contact", "make contact", "changeover contact" or as a flashing indicator. The changeover function is only available for the odd-numbered channels i.e. 1, 3, etc. The even-numbered channels are integrated in the changeover function as a second contact.



When changing over the relay operation mode, parameter settings and linked group addresses are modified by the ETS program. For this reason, the relay operation mode should be set before configuring the device.

● Relay operation: make contact

The relay in the switch actuator has a make contact. The switching state is transmitted directly to the relays.

Switch (make function) (EIB=KNX)

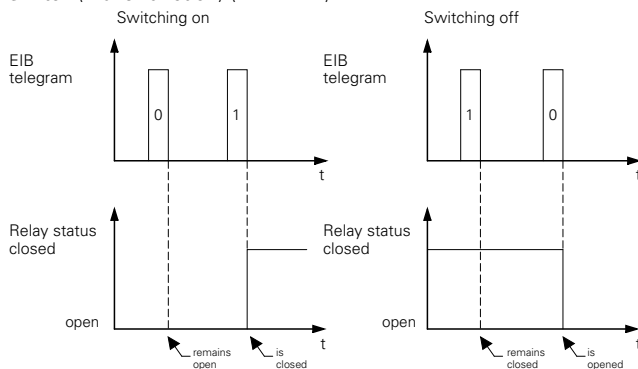

Status response

Each channel can deliver a status response, depending on the parameter settings. This always conveys the actual state of the output (1= relay closed; 0= relay opened).

After bus voltage recovery, the relay is normally opened in the "make contact" function. When the contact is opened and the status feedback function is active, no "0" telegrams are generated. In this case, a function with a higher priority enforces a different state and the corresponding status response telegram is produced.

Parameters

① Per channel: Select the "make contact" relay mode

Channel X: General	
Parameter	Setting
Relay operation	make contact
	break contact
	changeover contact (channel 1: make contact / channel 2: break contact)
	flash for ON
	flash for OFF

● Relay operation: break contact

The relay contact can be operated logically as a break contact (via software). The relay position is inverted and issued.

Switch (break function))

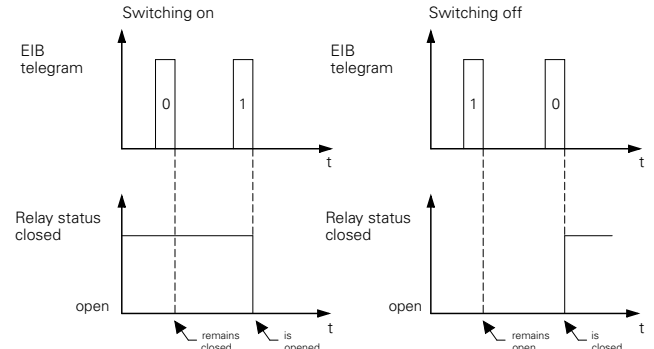

The fixed relay positions (open, closed) within the other functions are triggered directly. An inversion by means of the break contact function is no longer carried out for these fixed relay positions.

Status response

Each channel can deliver a status response, depending on the parameter settings. This always conveys the actual state of the output (1= relay closed; 0= relay opened).

After bus voltage recovery, the relay is normally closed in the "break contact" function and if the status feedback function is active, a status response telegram is generated with the value "1" after approx. 17 s. In this case, a function with a higher priority enforces a different state and the corresponding status response telegram is produced.

Parameters

① Per channel: Select the "break contact" relay mode

Channel X: General	
Parameter	Setting
Relay operation	make contact
	break contact
	changeover contact (channel 1: make contact / channel 2: break contact)
	flash for ON
	flash for OFF

● Relay operation: changeover contact

The changeover function is only available for the odd-numbered channels i.e. 1, 3, 5, 7, etc. The even-numbered channels are integrated in the changeover function as a second contact.

In this operation mode, the two adjacent channels e.g. "1" and "2" are combined logically as a changeover contact. The two relays then work inversely to each

other. The switching state is determined by the odd-numbered channel "1".

Switch (changeover contact for channel 1/2) (EIB=KNX)

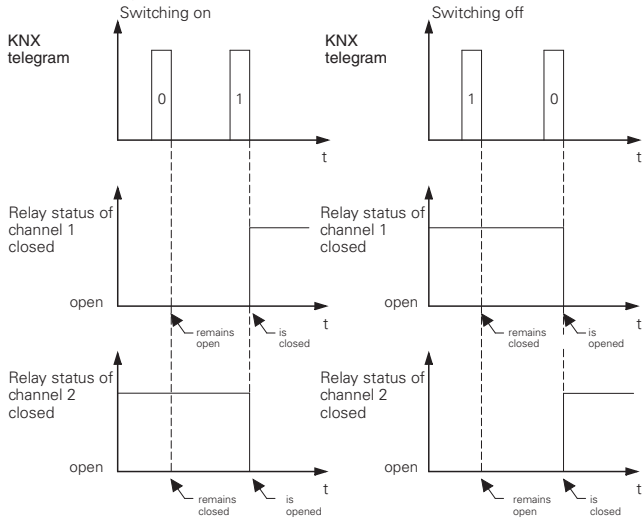

Status response

If two channels are combined into a changeover contact, there is only one status feedback object when the status response function is active.

This object always conveys the switching state of the odd-numbered channel e.g. "1" (1= relay closed; 0= relay opened).

Parameters

- ① Per pair of channels: Select the relay mode "changeover contact (channel 1: make contact / channel 2: break contact)"

Channel X: General	
Parameter	Setting
Relay operation	make contact
	break contact
	changeover contact (channel 1: make contact / channel 2: break contact)
	flash for ON
	flash for OFF

● Relay operation: flashing indicator

In the flashing indicator function, the relay opens and closes automatically. A common flashing rate can be set for all the channels via the "Flashing interval" parameter. The frequency is calculated by multiplying a base value with a factor.



Important

No short switching times may be parameterised under load (see the technical data for the switch output)

It can be selected whether the channel flashes for the value "ON" (actuated) or "OFF" (not actuated). The value is the product of combining the disable/higher priority function with the switch object.

Flash for ON

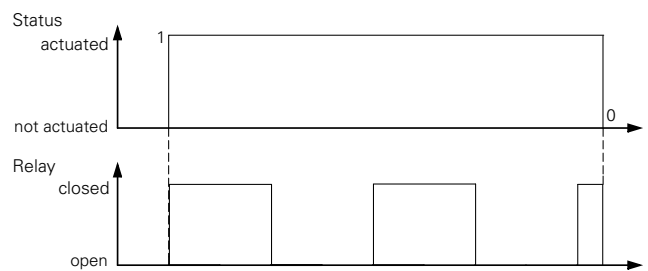

Status response

Each channel can deliver a status response, depending on the parameter settings. This always conveys the actual state of the output (1= relay closed; 0= relay opened).

Parameters

- ① Per channel: Select the relay mode "flash for ON" or "flash for OFF"

Channel X: General	
Parameter	Setting
Relay operation	make contact
	break contact
	changeover contact (channel 1: make contact / channel 2: break contact)
	flash for ON
	flash for OFF

- ② Set the flashing interval for the device.

Flashing interval	
Parameter	Setting
Flashing interval base	100 ms
	1 s
	1 min
1 hr	
Flashing interval factor [5-255]	10 adjustable in single steps

Switching functions

● Switching

Binary bus telegrams (EIS1 telegrams, 1 bit) are received via the "Switch object" and converted into switching states (relay open/relay closed). The application changes the value of the "Switch object" during operation. Reading out the "Switch object" via the bus does not convey the status of the relay. The status should always be read out via the "Status feedback object".

i The switching behaviour of the normal switch function can be modified by activating functions with a higher priority (see 'Priorities').

Switch (make function) (EIB=KNX)

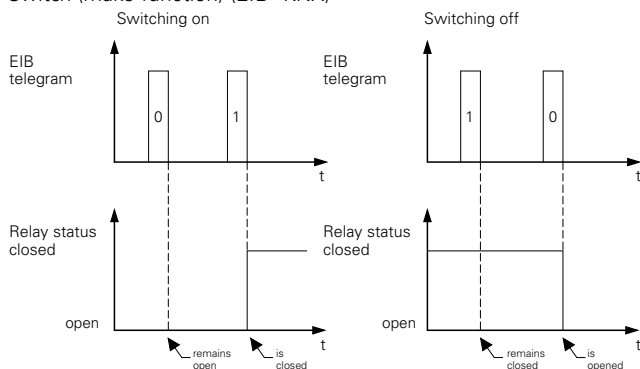

Switch (break function)

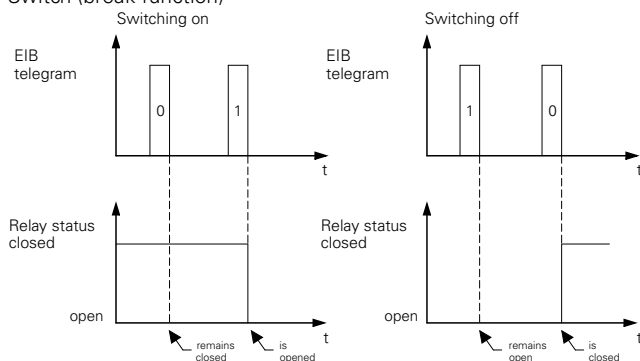

After bus voltage recovery, the relay is closed in the "break contact" mode and a status response telegram is generated with the value "1" if the status response function is activated. In this case, a different response is carried out e.g. by a higher priority function or due to the behaviour on bus voltage recovery at the output.

Before triggering the relay, a check is made to determine whether there is sufficient energy to operate the relay. If there is sufficient energy, the relay immediately switches to the parameterised state. Otherwise there is a delay until sufficient energy is available.

The fixed relay positions (open, closed) within the other functions are triggered directly. An inversion by the break contact function is not carried out for fixed relay positions.

Communication objects

The following communication objects can be selected:

Per channel:

Function	Object name	Type	Prio	Flags	Behaviour
Channel X	Switch object	1 bit	Low	CW	Receive

Parameters

- ① Per channel: Set the required relay operation mode.

Channel X: General	
Parameter	Setting
Relay operation	make contact
	break contact
	changeover contact
	flash for ON
	flash for OFF

● Central switching function

The central switching function has its own communication object (1 bit central object) It can be set for each channel of the actuator whether and how the channel should react to the central switch object. Using the parameters, you can set whether only the state "actuated" (make contact => closed and break contact => opened), only the state "not actuated" or both states of the central switch object for the channel should be evaluated.

The central function has a low priority. Telegrams from the central switch objects activate the set switching/ time functions and higher priority functions in the same way as telegrams from the corresponding switch object.

The last telegram from the individual switch object or the central object always activates the functions that have been set for the channel.

Communication objects

The following communication objects can be selected:

Common for all channels

Function	Object name	Type	Prio	Flags	Behaviour
Central function	Central object	1 bit	Low	CW	Receive

Parameters

- ① Switch on the central switching function (active).

Central function	
Parameter	Setting
Central function is	active
	not active

② Per channel: Set the central switching function.

Central function	
Parameter	Setting
Channel X	OFF at 0 or 1
	ON at 0 or 1
	ON at 0 / OFF at 1
	OFF at 0 / ON at 1
	OFF at 0 / no reaction at 1
	ON at 0 / no reaction at 1
	no reaction at 0 / OFF at 1
	no reaction at 0 / ON at 1
	no reaction at 0 or 1

Time functions

● ON delay

The output is switched on with a delay. The delay can be parameterised. The delay period is calculated by multiplying a base value with a factor. The set period can be defined via parameter as "retriggerable" or "not retriggerable". In the case of retriggerable time delays, the delay is restarted on receipt of a "1" telegram (switch object). If the delay is not retriggerable, the relay is opened once the period has elapsed.

If the output of the actuator is forced into a new switching position by a higher priority function while a delay is still running, the relay is switched without a delay.

Retriggerable ON delay (EIB=KNX)

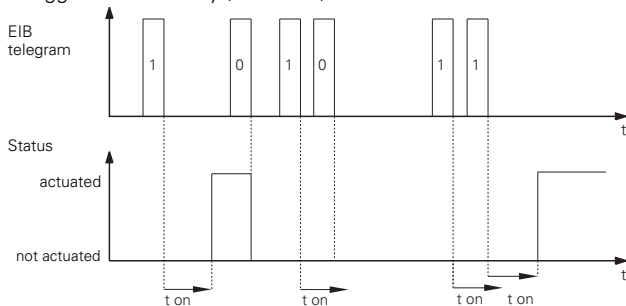

Non-retriggerable ON delay

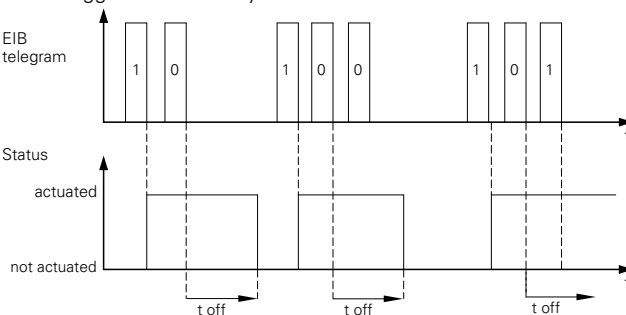

Actuated

The relay is closed in the make function. The relay is opened in the break function.

Communication objects

The following communication objects can be selected:

Per channel:

Function	Object name	Type	Prio	Flags	Behaviour
Channel X	Switch object	1 bit	Low	CW	Receive

Parameters

① Per channel: Switch on the ON delay.

Channel X: General	
Parameter	Setting
ON delay	switched on
	switched off

② Per channel: Set the ON delay.

Channel X: Times	
Parameter	Setting
Time base for ON delay	100 ms
	1 s
	1 min
	1 hr
Factor for ON delay (1-255)	3 adjustable in single steps
ON delay is	not retriggerable retriggerable

● OFF delay

The output is switched off without a delay. The delay can be parameterised. The delay period is calculated by multiplying a base value with a factor. The set period can be defined via parameter as "retriggerable" or "not retriggerable". In the case of retriggerable time delays, the delay is restarted on receipt of a "0" telegram (switch object). If the delay is not retriggerable, the relay is opened once the period has elapsed.

If the output of the actuator is forced into a new switching position by a higher priority function while a delay is still running, the relay is switched without a delay.

Retriggerable OFF delay

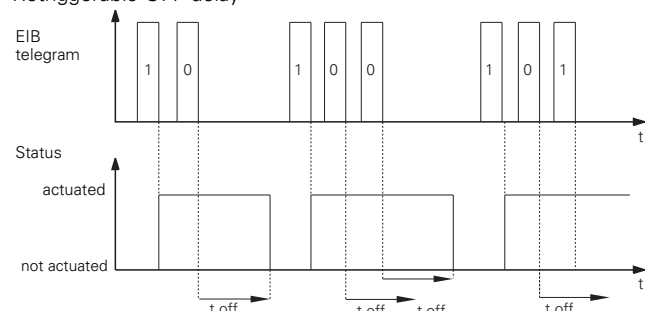

Non-retriggerable OFF delay (EIB=KNX)

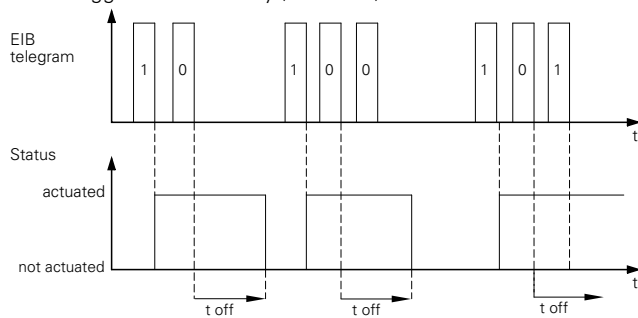

Actuated

The relay is closed in the make function. The relay is opened in the break function.

Communication objects

The following communication objects can be selected:

Per channel:

Function	Object name	Type	Prio	Flags	Behaviour
Channel X	Switch object	1 bit	Low	CW	Receive

Parameters

- ① Per channel: Switch on the OFF delay.

Channel X: General	
Parameter	Setting
OFF delay	switched on
	switched off

- ② Per channel: Set the OFF delay.

Channel X: Times	
Parameter	Setting
Time base for OFF delay	100 ms
	1 s
	1 min
	1 hr
Factor for OFF delay (1-255)	120 adjustable in single steps
OFF delay is	not retriggerable retriggerable

● ON delay and OFF delay

The combination of an ON delay and an OFF delay results in the output being switched on and off with a delay.

ON and OFF delay

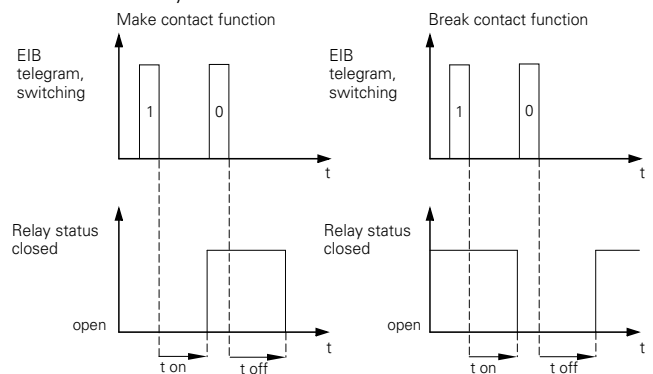

Communication objects

The following communication objects can be selected:

Per channel:

Function	Object name	Type	Prio	Flags	Behaviour
Channel X	Switch object	1 bit	Low	CW	Receive

Parameters

- ① Per channel: Switch on the ON and OFF delay.

Channel X: General	
Parameter	Setting
ON delay	switched on
	switched off
OFF delay	switched on
	switched off

- ② Per channel: Set the ON and OFF delay.

Channel X: Times	
Parameter	Setting
Time base for ON delay	100 ms
	1 s
	1 min
	1 hr
Factor for ON delay (1-255)	3 adjustable in single steps
ON delay is	not retriggerable retriggerable
Time base for OFF delay	100 ms
	1 s
	1 min
	1 hr
Factor for OFF delay (1-255)	120 adjustable in single steps
OFF delay is	not retriggerable retriggerable

● Staircase lighting function (staircase timer)

In the staircase lighting function, once the device has been switched on via the "Switch object", it switches itself off automatically after an adjustable period. In the "make contact" relay mode, the switch output is closed when the staircase timer is activated. The relay is opened in the "break contact" mode. In the relay mode "flash for ON", the switch output flashes while the staircase lighting function is active. In the relay mode "flash for OFF", the output flashes whenever the staircase lighting function is not activated.

Staircase lighting function (EIB=KNX)

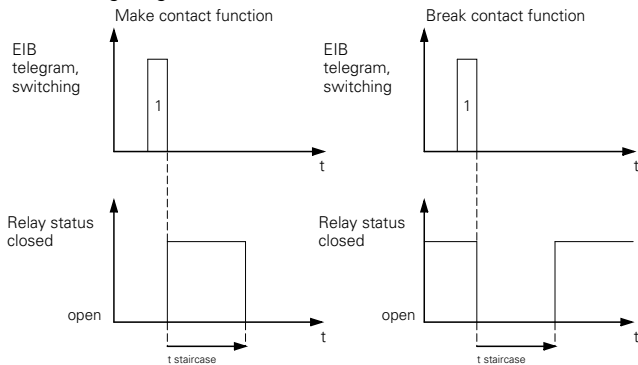

The period ($t_{\text{staircase}}$) is calculated by multiplying a base value by a factor.

The settings "retriggerable" or "not retriggerable" define whether the staircase timer is restarted by means of a further "1" telegram. If the staircase lighting function is "retriggerable", the period can be extended via the bus.

Retriggerable staircase lighting function without manual OFF function

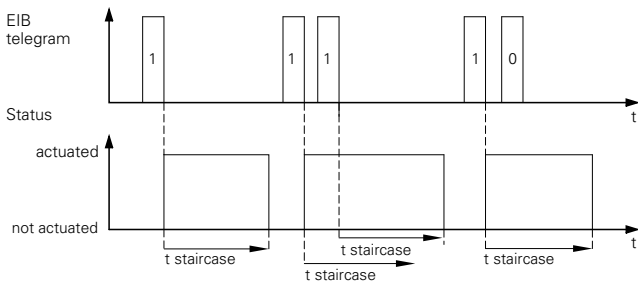

Non-retriggerable staircase lighting function without manual OFF function

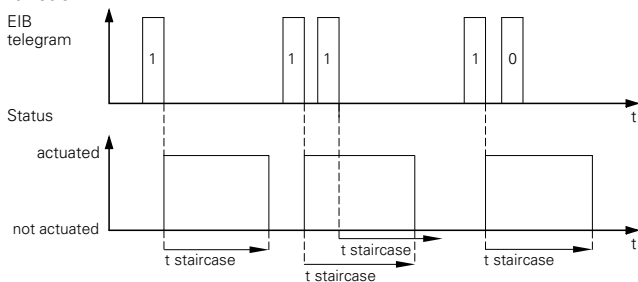

For the staircase lighting function, you can use the parameter "with / without manual OFF function" to set whether the timer is switched off prematurely after a

"0" telegram is received or whether the "0" telegram is ignored and the staircase timer continues to run.

Retriggerable staircase lighting function with manual OFF function

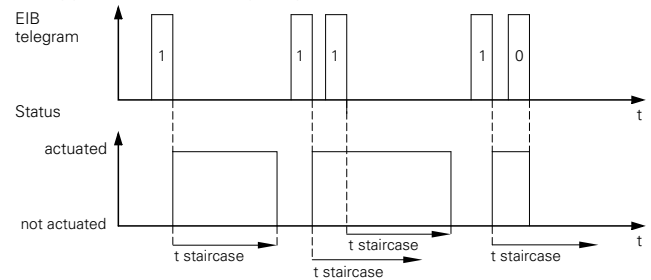

Non-retriggerable staircase lighting function with manual OFF function

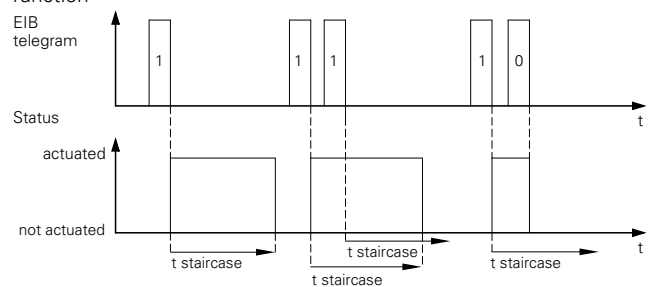

The staircase lighting function can indicate that the end of the staircase timer is imminent by causing the luminaire to flicker. It is possible to select between one and three warnings. It is possible to set the time (t_{warning}) when the warnings should start before the staircase timer has elapsed. The length of the interruptions (t_{I}) and the interval between two warnings (t_{int}) can also be set.

Staircase timer with prewarning

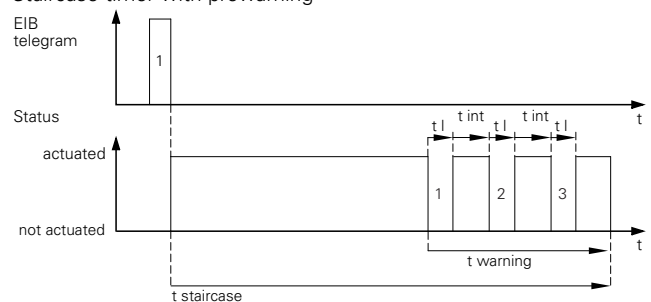

i In the case of staircase lighting functions with a manual OFF function and active prewarning, the staircase lighting function with prewarning is immediately deactivated when an OFF telegram is received.

If the output of the actuator is brought into a new switching position by a function with a higher priority while the staircase timer is active, the relay is immediately switched to this position. The last switching telegram is stored and any delay periods or staircase timers continue to run.

i Switching functions and staircase lighting functions cancel each other out i.e. they cannot be active at the same time. If the staircase

lighting function is parameterised, the channel only operates as a staircase timer. If the staircase lighting function is not set, the switching function is automatically active.

Communication objects

The following communication objects can be selected:

Per channel:

Function	Object name	Type	Prio	Flags	Behaviour
Channel X	Switch object	1 bit	Low	CW	Receive

Parameters

- Per channel: Switch on the staircase lighting function.

Channel X: General	
Parameter	Setting
Staircase lighting function	switched on switched off

- Per channel: Set the staircase lighting function.

Channel X: Staircase timer	
Parameter	Setting
Base for staircase timer	100 ms
	1 s
	1 min
	1 hr
Factor for staircase timer (1-255)	85 adjustable in single steps
Staircase time is	not retriggerable
	retriggerable
Staircase timer	with manual OFF
	without manual OFF
Prewarning at end of staircase time	OFF
	ON
Number of prewarnings	1
	2
	3
	Prewarning time (1-255), factor x 1 s
Time for interruptions (1-20), factor x 100 ms	5 adjustable in single steps
Time between prewarnings (1-255), factor x 1 s	5 adjustable in single steps

● ON delay and staircase lighting function

The combination of an ON delay with the staircase lighting function results in the delayed start of the staircase lighting function.

ON delay with staircase lighting function (EIB=KNX)

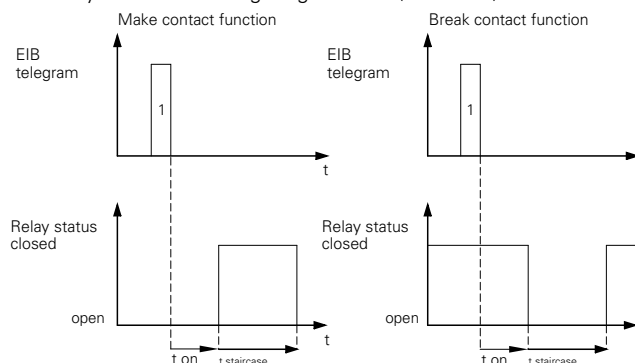

Communication objects

The following communication objects can be selected:

Per channel:

Function	Object name	Type	Prio	Flags	Behaviour
Channel X	Switch object	1 bit	Low	CW	Receive

Parameters

- Per channel: Switch on the ON delay and staircase lighting function.

Channel X: General	
Parameter	Setting
ON delay	switched on switched off
Staircase lighting function	switched on switched off

- Per channel: Set the ON delay.

Channel X: Times	
Parameter	Setting
Time base for ON delay	100 ms
	1 s
	1 min
	1 hr
Factor for ON delay (1-255)	3 adjustable in single steps
ON delay is	not retriggerable retriggerable

- Per channel: Set the staircase lighting function.

Channel X: Staircase timer	
Parameter	Setting
Base for staircase timer	100 ms
	1 s
	1 min
	1 hr
Factor for staircase timer (1-255)	85 adjustable in single steps
Staircase time is	not retriggerable
	retriggerable
Staircase timer	with manual OFF
	without manual OFF

Channel X: Staircase timer	
Parameter	Setting
Prewarning at end of staircase time	OFF ON
Number of prewarnings	1
	2
	3
Prewarning time (1-255), factor x 1 s	30 adjustable in single steps
Time for interruptions (1-20), factor x 100 ms	5 adjustable in single steps
Time between prewarnings (1-255), factor x 1 s	5 adjustable in single steps

● OFF delay and staircase lighting function

The OFF delay can only be activated when a pure switching function is selected or when combined with the setting "staircase lighting function with manual OFF". The parameters for the OFF delay are not displayed in the setting "staircase lighting function without manual OFF". The set OFF delay is started on receipt of an OFF telegram while the staircase timer is running.

Staircase lighting function with OFF delay (EIB=KNX)

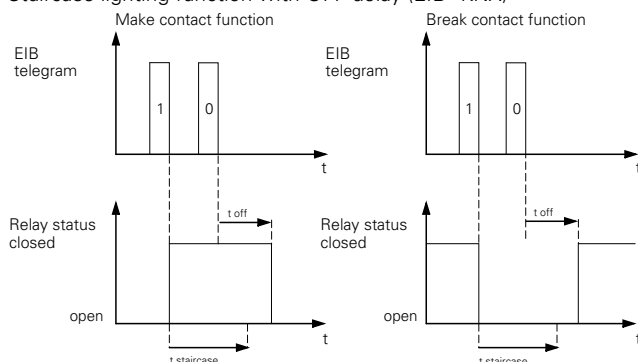

Staircase lighting function with prewarning and OFF delay

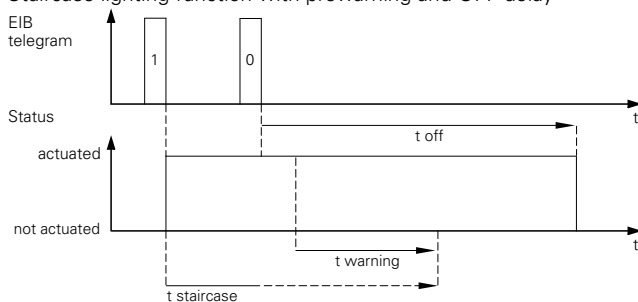

In the case of staircase lighting functions with a manual OFF function and active prewarning, the staircase lighting function with prewarning is immediately deactivated on receipt of an OFF telegram. The OFF delay elapses. No prewarning takes place.

Communication objects

The following communication objects can be selected:

Per channel:

Function	Object name	Type	Prio	Flags	Behaviour
Channel X	Switch object	1 bit	Low	CW	Receive

Parameters

- ① Per channel: Switch on the OFF delay and staircase lighting function.

Channel X: General	
Parameter	Setting
OFF delay	switched on switched off
Staircase lighting function	switched on switched off

- ② Per channel: Set the OFF delay.

Channel X: Times	
Parameter	Setting
Time base for OFF delay	100 ms
	1 s
	1 min
	1 hr
Factor for OFF delay (1-255)	120 adjustable in single steps
OFF delay is	not retriggerable retriggerable

- ③ Per channel: Set the staircase lighting function.

Channel X: Staircase timer	
Parameter	Setting
Base for staircase timer	100 ms
	1 s
	1 min
	1 hr
Factor for staircase timer (1-255)	85 adjustable in single steps
Staircase time is	not retriggerable retriggerable
Staircase timer	with manual OFF without manual OFF
Prewarning at end of staircase time	OFF ON
Number of prewarnings	1
	2
	3
Prewarning time (1-255), factor x 1 s	30 adjustable in single steps
Time for interruptions (1-20), factor x 100 ms	5 adjustable in single steps
Time between prewarnings (1-255), factor x 1 s	5 adjustable in single steps

Higher-level functions

With regard to the switching behaviour of the actuator, the higher priority functions take precedence over the switching function, staircase lighting function and time delays. If a higher priority function is active, changes to the switch object no longer affect the relay output. The status of the relay remains in the position which was preselected by the higher priority function. Higher priority functions are carried out without a delay i.e. delay periods are not taken into account when switched to a higher priority state.

There are three higher priority functions available: the disable function, logic operations and the priority control function. Logic operations and priority control functions cancel each other out i.e. only one of the two functions can be used per channel.

The logic operation or priority control function has a lower priority than the disable function. If a logic operation and the disable function occur at the same time, the disable function takes priority. Each channel has an object for each higher priority function (logic, priority or disable object).

All three functions are activated by means of parameters.



When switching between the functions, the parameter settings and communication objects of these functions are modified by the ETS program. Linked group addresses are deleted. For this reason, the function should be defined first.

● Disable function

The functionality of the selected switch actuator channel can be deactivated with the help of the "Disable object". Telegrams via the "Switch object" or status changes from the logic/priority function are no longer converted into switching commands at the relay when the disable function is activated.

The disable function can be triggered by a "1" or by a "0" telegram. (Disable object = 1 or disable object = 0).

Using the parameter "Value of disable object after bus voltage recovery", you can define whether the disable function is only effective after receipt of a disable telegram via the "Disable object" or immediately after a RESET.

With the parameter "Reaction at blocking", the output is set to the required position for the disable function. Telegrams to the "Switch object" are received and the last telegram is saved each time. When the disable function is no longer active, it is possible to define the relay state with the parameter setting "Reaction at activation".

Disable function for: Disable object = 1; Value of disable object after bus voltage recovery: 0; Reaction at blocking: no change; Reaction at activation: follows switch object (EIB=KNX)

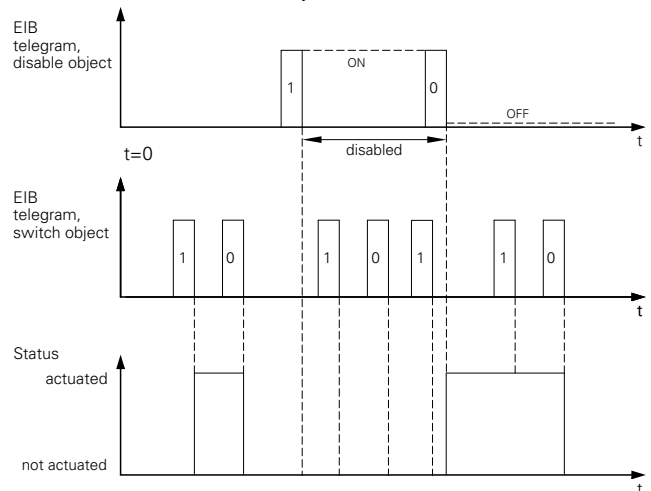

Communication objects

The following communication objects can be selected:

Per channel:

Function	Object name	Type	Prio	Flags	Behaviour
Channel X	Switch object	1 bit	Low	CW	Receive
Channel X	Disable object	1 bit	Low	CW	Receive

Parameters

- ① Per channel: Switch on the disable function.

Channel X: General	
Parameter	Setting
Disable function	switched off
	switched on

- ② Per channel: Set the disable function.

Channel X: Disable	
Parameter	Setting
Disable function for	Disable object = 0
	Disable object = 1
Value of disable object after bus voltage recovery	1 0
Reaction at blocking	no change
	changes state
	actuated
	not actuated flashes
Reaction at activation	no change
	follows switch object
	actuated not actuated
Reaction at activation (with active staircase lighting function)	follows switch object
	not actuated

③ Set the flashing interval for the device if required.

Flashing interval	
Parameter	Setting
Flashing interval base	100 ms
	1 s
	1 min
	1 hr
Flashing interval factor [5-255]	10 adjustable in single steps



Important

No short switching times may be parameterised under load (see the technical data for the switch output)

● Disable function with switching delay/staircase lighting function

When the disable function is activated, it always switches in the required direction without a delay. When it is deactivated, the actuator likewise switches to the required state without a delay. The last switching telegram is saved during a disable function and any delay periods or staircase timers continue to run.

Disable function for: Disable object = 1; Value of disable object after bus voltage recovery: 0; Reaction at blocking: no change; Reaction at activation: follows switch object; Relay: make contact (EIB=KNX)

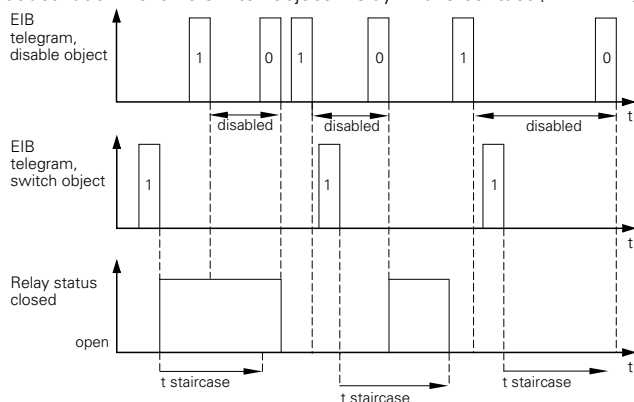

Communication objects

The following communication objects can be selected:

Per channel:

Function	Object name	Type	Prio	Flags	Behaviour
Channel X	Switch object	1 bit	Low	CW	Receive
Channel 1, 2, ...	Disable object	1 bit	Low	CW	Receive

Parameters

① Per channel: Switch on the ON/OFF delay, staircase lighting function and disable function.

Channel X: General	
Parameter	Setting
Disable function	switched off
	switched on
ON delay	switched on
	switched off
OFF delay	switched on
	switched off
Staircase lighting function	switched off
	switched on

② Per channel: Set the disable function.

Channel X: Disable	
Parameter	Setting
Disable function for	Disable object = 0
	Disable object = 1
Value of disable object after bus voltage recovery	1
Reaction at blocking	no change
	changes state
	actuated
	not actuated
Reaction at activation	no change
	follows switch object
	actuated
Reaction at activation (with active staircase lighting function)	follows switch object
	not actuated

③ Per channel: Set the ON and OFF delay.

Channel X: Times	
Parameter	Setting
Time base for ON delay	100 ms
	1 s
	1 min
	1 hr
Factor for ON delay (1-255)	3 adjustable in single steps
ON delay is	not retriggerable
	retriggerable
Time base for OFF delay	100 ms
	1 s
	1 min
	1 hr
Factor for OFF delay (1-255)	120 adjustable in single steps
OFF delay is	not retriggerable
	retriggerable

④ Per channel: Set the staircase lighting function.

Channel X: Staircase timer	
Parameter	Setting
Base for staircase timer	100 ms
	1 s
	1 min
	1 hr
Factor for staircase timer (1-255)	85 adjustable in single steps
Staircase time is	not retriggerable
	retriggerable
Staircase timer	with manual OFF
	without manual OFF
Prewarning at end of staircase time	OFF
	ON
Number of prewarnings	1
	2
	3
Prewarning time (1-255), factor x 1 s	30 adjustable in single steps
Time for interruptions (1-20), factor x 100 ms	5 adjustable in single steps
Time between prewarnings (1-255), factor x 1 s	5 adjustable in single steps

● **Logic operations**

With this functionality, the "Switch object" can be logically linked with the "Logic object". An AND or OR logic operation can be set. A parameter defines which value is preassigned to the logic object after bus voltage recovery.

For example, if the OR logic object is preset to "1" after bus voltage recovery, the output remains switched on until a "0" telegram has been received at the "Logic object". Any parameterised reaction after bus voltage recovery is only adopted once the logic operation has finished.

The logic function has a high priority. The actuator will thus always be set according to the logic result of the higher priority function and not the status of functions with a lower priority.

AND logic operation

If the "Logic object" is set to "1", switching can be carried out as usual via the address of the "Switch object". Any set delay periods and staircase timers are followed. Switching off via the "Logic object" takes place immediately (object with higher priority). An OFF delay is no longer carried out. If the "Logic object" is set to "1" again by a telegram, the output is also switched without a delay when the ON delay is activated.

Example:

A closing lock-out can be implemented with an AND logic operation. This means that it is not possible to switch on the output via the "Switch object" while the value of the "Logic object" remains set to "0". If the value of the "Switch object" is set to "1", the output is

switched on automatically following a change in the value of the logic object from "0" to "1" (output is set).

AND logic operation; Value of the logic object after bus voltage recovery: 1; Relay: make contact (EIB=KNX)

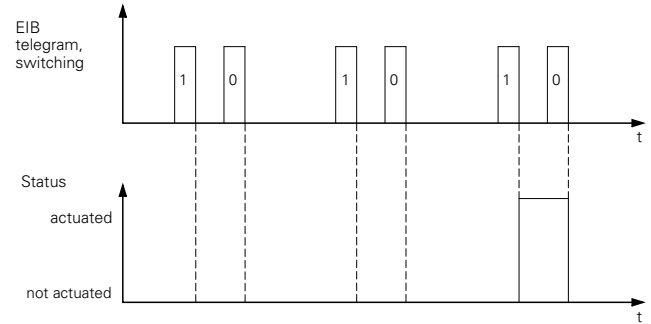
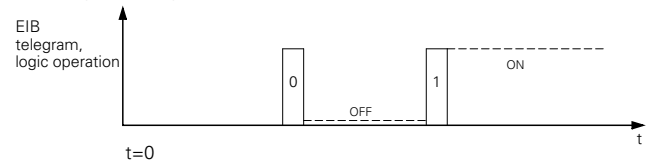

The logic object is preassigned the value "1" after a RESET. Switching can therefore be carried out as usual via the switch object. The closing lock-out is only active after the receipt of a "0" telegram via the logic object.

AND logic operation; Value of the logic object after bus voltage recovery: 0; Relay: make contact

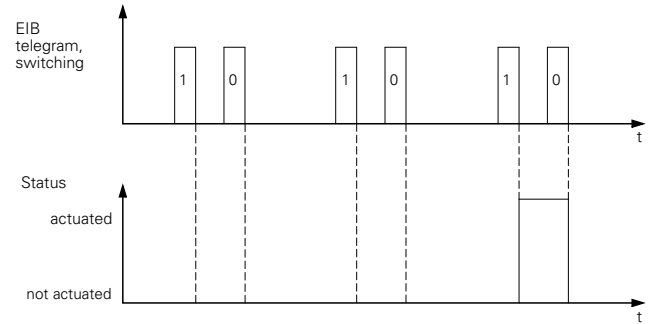
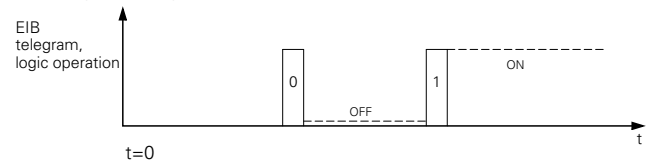

The parameter setting causes the "Logic object" to be set to the value "0". After a RESET, the actuator will not switch the output in the "make contact" mode nor with these settings, until a "1" telegram has been received at the "Logic object".

Communication objects

The following communication objects can be selected:

Per channel:

Function	Object name	Type	Prio	Flags	Behaviour
Channel X	Switch object	1 bit	Low	CW	Receive
Channel X	Logic object	1 bit	Low	CW	Receive

Parameters

- ① Per channel: Switch on the logic operation.

Channel X: General	
Parameter	Setting
Priority function	none
	Logic operation
	Priority control

- ② Switch on the AND logic operation and set the logic behaviour after a RESET.

Channel X: Logic function	
Parameter	Setting
Type of logic operation	OR
	AND
Value of logic object after bus voltage recovery	1
	0

OR logic operation

While the "Logic object" has the value "0", switching can be carried out as usual via the address of the "Switch object". Any set delay periods are still valid. The closing of the relay is carried out immediately via a "1" telegram to the "Logic object" (object with higher priority). A delay is no longer carried out. If the value of the "Logic object" is then set to "0" again, the actuator immediately switches to the required state.

Example:

An opening lock-out or central ON function (e.g. lighting for cleaning buildings) can be implemented with an OR logic operation. If the value of the "Switch object" is also set locally to "1", the relay remains closed when the opening lock-out is removed (value of the logic object changes from "1" to "0").

OR logic operation; Value of logic object after bus voltage recovery: 0; Relay: make contact (EIB=KNX)

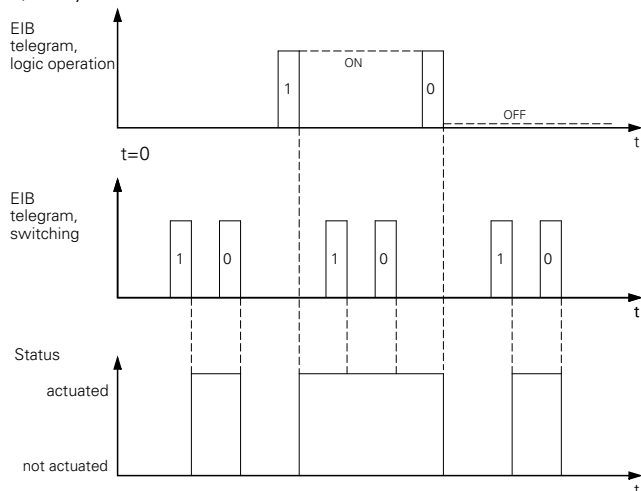

The relay can only be opened via the "Switch object" once a "0" telegram has been received via the "Logic object".

OR logic operation; Value of logic object after bus voltage recovery: 1; Relay: make contact

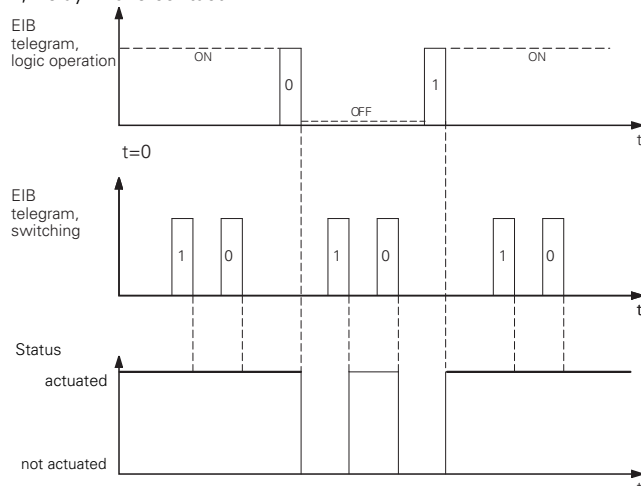

i The logic object is preassigned the value "1" after a RESET. The actuator will immediately switch on the output in the "make contact" mode. The OR logic function is only reset by a "0" telegram at the logic object.

Communication objects

The following communication objects can be selected:

Per channel:

Function	Object name	Type	Prio	Flags	Behaviour
Channel X	Switch object	1 bit	Low	CW	Receive
Channel X	Logic object	1 bit	Low	CW	Receive

Parameters

- ① Per channel: Switch on the logic operation.

Channel X: General	
Parameter	Setting
Priority function	none
	Logic operation
	Priority control

- ② Switch on the OR logic operation and set the logic behaviour after a RESET.

Channel X: Logic operation	
Parameter	Setting
Type of logic operation	OR
	AND
Value of logic object after bus voltage recovery	1
	0

● Priority control

There is a 2 bit priority object in addition to the 1 bit switch object. The switch actuator channel is switched to high priority switching states (relay opened / relay closed) with the 2 bit telegram. If the 2 bit priority object receives a telegram whose first bit (bit 1) has the value ON "1", the priority control function is active. In this case, the switch actuator switches to the state that was defined by the second bit (bit 0) of the telegram.

Bit 1	Bit 0	Function
1	1	Switched on with priority (output actuated)
1	0	Switched off with priority (output not actuated)
0	1	Priority control function not active (output behaves according to parameter "Reaction after priority")
0	0	Priority control function not active (output behaves according to parameter "Reaction after priority")

Bit 0=1 leads to the closing of the relay in the "make contact" relay mode and to the opening of the relay in the "break contact" relay mode.

Bit 0=0 leads to the output being switched off in the "make contact" relay mode and to the output being switched on in the "break contact" relay mode.

If the switch object receives switching telegrams during a priority control function, the last telegram is stored each time and is evaluated, if necessary, when the priority function is removed (according to the parameter settings).

Using the parameter "Reaction after priority", you can set how the respective channel should behave when the priority function is removed (first bit (bit 1) is set to zero "0"). The actuator can be switched on or off (actuated/not actuated), can follow the current state of the switch object or retain the current state (no change).

When the staircase lighting function is active, there are fewer options available for selection.

Priority control is carried out without a delay.

The function of the priority control after bus voltage recovery can be defined by means of a further parameter. The output can be "actuated with priority", "not actuated with priority" or no active priority can be selected.

Priority control (EIB=KNX)

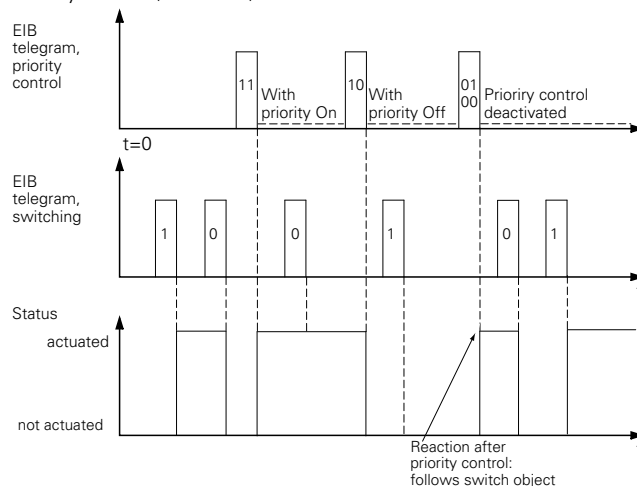

Communication objects

The following communication objects can be selected:

Per channel:

Function	Object name	Type	Prio	Flags	Behaviour
Channel X	Switch object	1 bit	Low	CW	Receive
Channel X	Priority control object	2 bit	Low	CW	Receive

Parameters

- ① Per channel: Switch on the priority control function.

Channel X: General	
Parameter	Setting
Priority function	none
	Logic operation
	Priority control

- ② Set the priority control function.

Channel X: Priority control	
Parameter	Setting
Reaction after priority	no change
	follows switch object
	actuated
	not actuated
Function of priority after bus voltage recovery	no active priority
	actuated with priority
	not actuated with priority

Scenes

● Scene

The scene function of the switch actuator has an 8 bit scene object. Using a parameter, you can define for each scene whether the scene should be inactive, active or active with a memory function for new actuator states. A parameter window appears for each active scene where the settings can be carried out. 8 independent values can be stored for each channel. When the scene is retrieved, it can be specified that the channel switches on, switches off or does not change its state.

A scene is activated when it receives its scene number (1 byte value starting with "0") at the scene object. If a scene is parameterised with a memory function, the storing of the current channel values is carried out using the object value of the scene (scene number) + 128 (see table).

Scene	Object value (scene number)	Function
1	0	Retrieve scene 1
1	128	Save scene 1
2	1	Retrieve scene 2
2	129	Save scene 2
3	2	Retrieve scene 3
3	130	Save scene 3
4	3	Retrieve scene 4
4	131	Save scene 4
5	4	Retrieve scene 5
5	132	Save scene 5
6	5	Retrieve scene 6
6	133	Save scene 6
7	6	Retrieve scene 7
7	134	Save scene 7
8	7	Retrieve scene 8
8	135	Save scene 8

The scene function has likewise a low priority. Its behaviour in combination with other functions corresponds to the behaviour of the central function.

Communication objects

The following communication objects can be selected:

Function	Object name	Type	Prio	Flags	Behaviour
Scene	Scene object	1 byte	Low	CW	Receive

Parameters

- ① Common for all scenes: Activate the scenes.
- ② Define for Scene 1-8:
not active / retrievable / retrievable and storable.

General scene	
Parameter	Setting
Scenes are	not active
	active

General scene	
Parameter	Setting
Scene 1-8 is	not active
	retrievable
	retrievable and storable

- ③ Per scene: Set the actuator channels.

Scene 1-8	
Parameter	Setting
Channel 1	ON
	no change
	OFF
Channel 2 (only when channel 1 not a changeover contact)	ON
	no change
	OFF
...	...
Channel X	ON
	no change
	OFF
Channel X+1 (only when channel X not a changeover contact)	ON
	no change
	OFF

● Status information (status response)

The status of the output can be read via its own communication object or actively sent. This means that the status of the relay is available as a telegram on the bus after each switching process. The value of the "Status feedback object" always conveys the current status of the relay. When the relay is closed, the value is "1" while the value is "0" when the relay is opened, regardless of the relay operation mode. After bus voltage recovery, a status feedback telegram with the value "1" is sent via the "Status feedback object" after approx. 17 s when the relay is closed and the active status response function is switched on. When the contact is opened, no "0" telegrams are generated.

If two channels are combined into a changeover contact, there is only one status feedback object.

i Manual operations (for 2-gang and 4-gang switch actuators) on the device were not recognised. The status therefore no longer corresponds to the status of the output. The correct status is only available again after a switching operation via the bus.

The passive status object conveys the status of the relay at any instant (e.g. for visualisation programs which actively read out the status).

Active feedback with a parameterised ON and OFF delay (EIB=KNX)

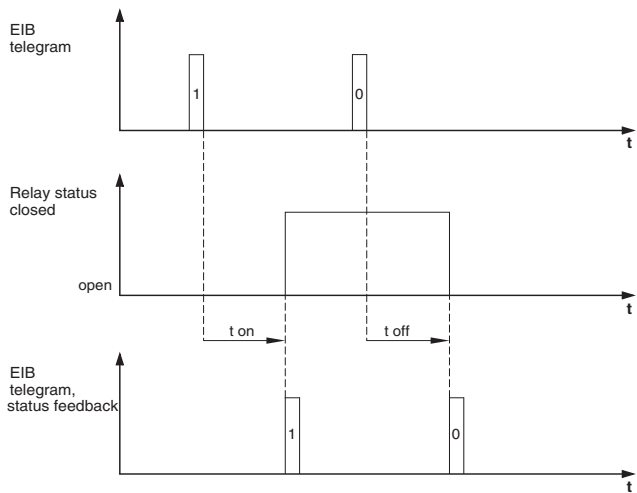

Communication objects

The following communication objects can be selected:

Per channel:

Function	Object name	Type	Prio	Flags	Behaviour
Channel X	Status object	1 bit	Low	CR	Receive
Channel X	Status feedback object	1 bit	Low	CT	Transmit

Parameters

- ① Per channel: Switch on the active status response or passive status information.

Channel X: General	
Parameter	Setting
Status information	switched off
	active status feedback object
	passive status object