

**Control unit 0-10 V REG-K/3-gang with manual mode**

Operating instructions

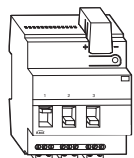

Art. no. MTN646991

**For your safety**

**DANGER**  
**Risk of fatal injury from electrical current.**  
 All work on the device should only be carried out by trained and skilled electricians. Observe the country-specific regulations as well as the valid KNX guidelines.

**CAUTION**  
**Damage to the device.**  
 - Only operate the device according to the specifications stated in the Technical data.  
 - All the devices that are mounted next to the control unit must at least be fitted with basic insulation.

**Control unit introduction**

The control unit 0-10 V REG-K/3-gang with manual mode dims and switches fluorescent lamps using electronic ballasts with a 0-10 V/1-10 V interface and LV halogen lamps using transformers with a 0-10 V/1-10 V interface.

**i** The control voltage range can be set with the ETS via a parameter.

You can also manually switch the connected loads with the manual switches on the control unit without bus voltage.

The control unit has a bus coupler. It is installed on a DIN rail acc. to EN 60715, with the bus connection made via a bus connecting terminal. A data rail is not required.

**Connections, displays and operating elements**

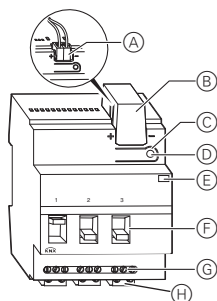

- (A) Bus connecting terminal
- (B) Cable cover
- (C) Programming button
- (D) Programming LED (red)
- (E) Operating LED "RUN" (green)
- (F) Manual switch
- (G) Channel terminals for load voltage
- (H) Outputs 1-10 V

**Installing the control unit**

① Set the control unit onto the DIN rail.

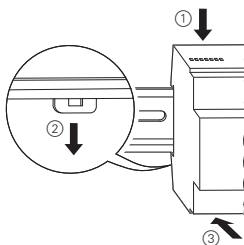

② Connect KNX.

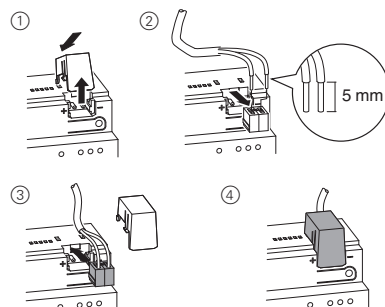

**WARNING**  
**Risk of fatal injury from electrical current. The device could become damaged.**  
 Safety clearance must be guaranteed in accordance with IEC 60664-1. There must be at least 4 mm between the individual cores of the 230 V supply cable and the KNX line.

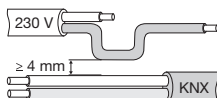

**WARNING**  
**Risk of fatal injury from electrical current. The device could become damaged.**  
 Disconnect the mains voltage before connecting the device to the load.  
 Terminals may not be inserted under load.

③ Connect the bus voltage.

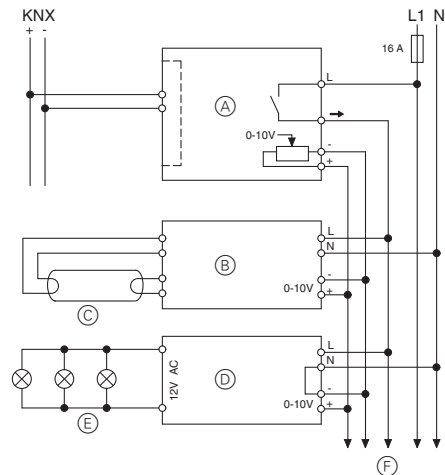

- (A) Control unit
- (B) Electronic ballast with 0-10 V/1-10 V interface
- (C) Fluorescent lamp
- (D) Electronic transformer with 0-10 V/1-10 V control input
- (E) LV halogen lamps
- (F) To other devices with 0-10 V/1-10 V interface

④ Connect the load.  
 ⑤ Connect the load voltage.

**Putting the actuator into operation**

① Press the programming button.  
 The programming LED lights up.  
 ② Load the physical address and application into the device from the ETS.  
 The programming LED goes out.  
 The operating LED lights up: The application was loaded successfully, the device is ready for operation.

## Technical data

Supply from KNX:	DC 24 V / approx. 17.5 mA
Insulation voltages:	AC 4 kV bus/mains voltage and bus/0-10 V AC 4 kV 0-10 V - mains voltage
Switch contact:	Make contact, floating

### Connection data for each channel:

Nominal current:	16 A, inductive $\cos \varphi = 0.6$
Incandescent lamps:	AC 230 V, 3600 W
Halogen lamps:	AC 230 V, 2500 W
LV halogen lamps:	max. 2000 VA via electronic transformers
Fluorescent lamps:	AC 230 V, 5000 W, uncompensated AC 230 V, max. 2500 VA parallel-compensated
Capacitive load:	AC 230 V, 3600 W, 200 $\mu\text{F}$
Protection:	The switch contact must be protected by a 16 A series-connected circuit-breaker.
Service life:	> 50,000 switching cycles at nominal load
0-10V/1-10V Interface:	0-10 V for dimming electronic ballasts
Loading capacity:	max. 100 mA (max. 50 electronic ballasts, depending on EB)
Min. control voltage:	0 V

### Ambient temperature

Operation:	-5 °C to +45 °C
Storage:	-25 °C to +55 °C
Transport:	-25 °C to +70 °C
Max. humidity:	93 %, no moisture condensation
Environment:	Can be used at up to 2000 m above sea level (MSL)
Operating elements:	1 programming button 1 manual switch per channel
Display elements:	1 red LED: programming check 1 green LED: ready for operation, "RUN"

### Connections

Bus:	via two 1 mm pins for bus connecting terminal
Live conductor and switch output:	3-gang screw terminals for max. 2.5 mm <sup>2</sup>
1-10 V output:	2-gang pluggable screw terminals for max. 2.5 mm <sup>2</sup>
EC directives:	complies with Low-Voltage Directive 73/23/EEC, complies with EMC Directive 89/336/EEC
Device width:	4 modules = approx. 72 mm

## Schneider Electric Industries SAS

If you have technical questions, please contact the Customer Care Center in your country.

[www.schneider-electric.com](http://www.schneider-electric.com)

This product must be installed, connected and used in compliance with prevailing standards and/or installation regulations. As standards, specifications and designs develop from time to time, always ask for confirmation of the information given in this publication.

## Universal dimming 3211/1.0

### ● General information on the application

You can use this software application to program the control unit from the REG-K range with a manual mode. The control unit controls the brightness of the connected lamp. You can configure the control functions separately for each control unit output channel.

You can also switch the control unit on or off via the channel switch on the front side of the device. For more information see the "Manual operation" section. Group addresses are managed dynamically. The maximum number of group addresses and assignments is 172.

The limit for the telegram rate of the device is set to 127 telegrams every 17 seconds.

Attention: If you switch back to the preset values in the ETS, all of the changes you have made so far will be reset.

**i** Note: Due to the fact that some functions depend on other functions, the corresponding tabs and parameters for these functions will only be visible for selection in the ETS when the respective functions are activated or have been enabled.

If you disable functions or change parameters, group addresses that have already been connected may be deleted again.

**i** Note: The values of some parameters only become active when the functions which are influenced by these parameters are activated.

**i** Configurable times (staircase timer, ON delay, OFF delay, etc.) are set via the time base and time factor parameters. The actual time is calculated by multiplying both values; e.g. time base 1 second multiplied by time factor 3 equals 3 seconds.

If only one of these parameters is displayed, it will not be possible to set the time for the selected parameter setting. However, if appropriate, other factors in other tabs may influence the times.

### ● Application functions

With this software application, the control unit is capable of executing the following functions:

#### - Basic functions

Switching (1 bit), relative dimming (4 bit), absolute dimming/value dimming (1 byte)

#### - Advanced functions

Time functions (ON/OFF delay, staircase timer), scenes, central function

#### - Higher priority functions

Logic operation or priority operation, disable function

The individual functions and the parameter setting options in the ETS are described in the sections below.

### ● Setting the dimming parameters

#### Dimming range

The range between the minimum and maximum brightness of a lamp which can be set with the aid of an electronic ballast is specified by the technical dimming range.

The minimum brightness value which can be set corresponds to a dimming value of 1%.

The maximum brightness value which can be set corresponds to a dimming value of 100%

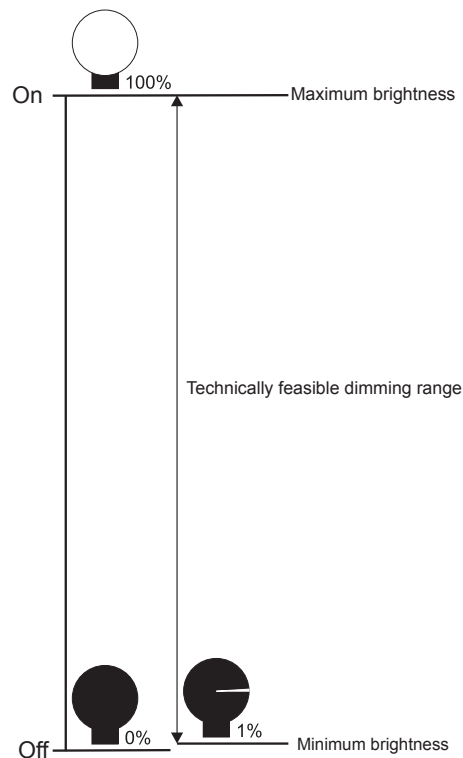

## Universal dimming 3211/1.0

Use the software application to limit the technically possible dimming range to a minimum and a maximum dimming value. This limitation can be set individually for each output channel.

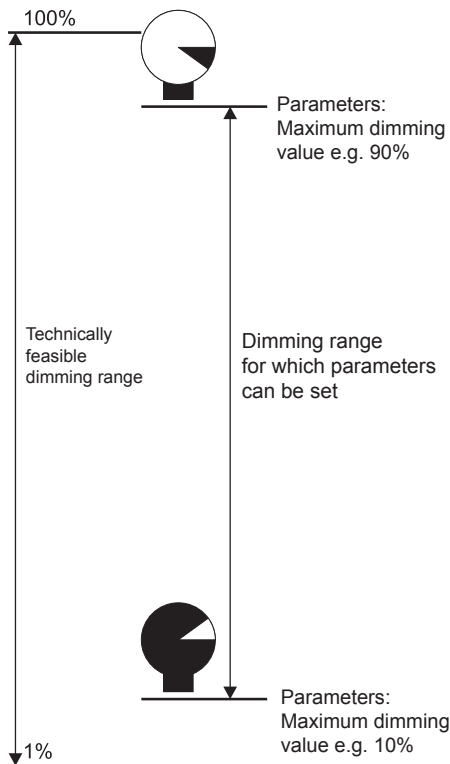

The parameterisable dimming range is set using the following parameters:

Tab	Parameter
X: General	Minimum dimming value in %
	Maximum dimming value in %

The limits of the parameterisable dimming range may not be crossed. If, regardless of the function, a telegram that demands a lower or a higher value is received, the respective minimum or maximum value will be set (for information on the function options, please refer to the section later on in this manual).

Example: minimum dimming value = 10%, maximum dimming value = 90%

Telegram value = 5% => output = 10%

Telegram value = 70% => output = 70%

Telegram value = 95% => output = 90%

### ● Basic dimming curve

You can use the basic dimming curve to adjust the control behaviour of a channel to the physical characteristics of different lamps.

Specific basic dimming curves are stored in the software application for incandescent lamps and halogen lamps. You can select the basic dimming curve for each channel via a parameter:

Tab	Parameter
X: General	Basic dimming curve

If you wish to set your own dimming curve, select "adjustable". You can then change the setting of the threshold values and the times of the dimming sections in the "Basic dimming curve" tab:

Tab	Parameter
X: Basic dimming curve	1st threshold value in %
	2nd threshold value in %
	3rd threshold value in %
	Time base for 1st dimming section
	Time factor for 1st dimming section (1 - 255)
	Time base for 2nd dimming section
	Time factor for 2nd dimming section (1 - 255)
	Time base for 3rd dimming section
	Time factor for 3rd dimming section (1 - 255)
	Time base for 4th dimming section
	Time factor for 4th dimming section (1 - 255)

The basic dimming curve is divided into four dimming sections. You can determine the initial value of the dimming curve via the parameter value "Minimum dimming value in %", and the final value via the "Maximum dimming value in %" parameter value. The stages in between are determined by three threshold values.

With the time base and time factor, you define the length of time until the next threshold value is reached.

This change to the dimming value over time equals the dimming speed.

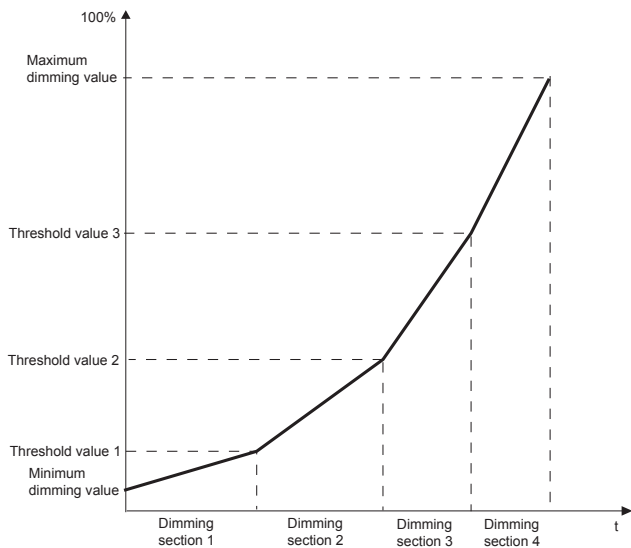

**i** Note: The dimming curve (the actual voltage curve applied to the output over the time period) is still influenced by the dimming time reductions of the dimming reduction sets and the dimming time reduction object; refer to the section on dimming speed.

When setting your own dimming curves, observe the following limitations:

- The period for running through an entire dimming curve is limited to 24 hours. Should longer running times result from the settings you have made, the software application will automatically determine a corrective factor to cut your settings back down to 24 hours.

- The following conditions apply for the set threshold values: The 1st threshold value must be larger than or equal to the set minimum dimming value. Otherwise, the 1st threshold value will be set equal to the minimum value. The 2nd threshold value must be larger than or equal to the 1st threshold value; otherwise, it will be set as equal to it. The 3rd threshold value must be larger than or equal to the 2nd threshold value; otherwise, it will be set as equal to it. If the 3rd threshold value is larger than the maximum dimming value, this maximum value will define the upper brightness limit.

**i** Brightness levels which are approximately the same are located between dimming values with the sequence 10, 20, 50, 100 (%).

**i** When the **Minimum dimming value in %** setting is equal to 10% the control range will be restricted to 1 V - 10 V. Here the **Dimming object switches channel** parameter must be parameterised to **only on, not off**. If an electronic ballast is connected which transforms a control voltage of less than 1 V, the minimum brightness can be reduced.

## ● Dimming speed

In the basic dimming curve, you define a basic dimming speed.

This basic dimming speed is then further increased by the reductions in dimming time.

The actual dimming speed therefore results from the time factors for the basic dimming curve and the parameters for the reductions in dimming time.

Here, you can set a dimming time reduction once, regardless of the function or telegram type, and you can also activate another dimming time reduction object via which the dimming time can again be reduced.

The reductions in dimming time always uniformly influence all dimming sections in the basic dimming curve.

You can use these parameters or this object to then reduce the dimming speed of the basic dimming curve. When the value for these parameters or for this object is 100% or 225, the dimming speed corresponds to the total of the basic dimming curve times. When the value is 50%, the dimming time of the basic dimming curve is halved, for example.

**i** Since the dimming time can only be reduced with these reductions in dimming time or the dimming time reduction object, it makes sense to parameterise the basic dimming curve to the maximum times required. The speeds can then be adapted to the respective functions using the dimming time reductions in the dimming time reduction sets.

**i** If the dimming time reduction object is deactivated, or dimming time reduction sets 1 to 3 are disabled, the basic dimming curve will be subjected to the dimming time reductions in set 0.

The preset values in this set thus always give different dimming speeds for different functions or incoming telegram types. Only when all dimming time reductions in set 0 are parameterised to 100% or 225 will the dimming speed for all incoming telegrams correspond to the basic dimming curve.

You can define a total of four dimming time reduction sets, which you can then activate using the set object.

You can use the dimming time reduction parameter format to select the input format for this parameter: input in percentage steps via a selection list (1% to 100% in defined steps), or numerical input (1 to 225). With numerical input, the value 225 corresponds to 100%.

Tab	Parameter
X: Dimming time reductions	Format for dimming time reductions for sets

## Universal dimming 3211/1.0

### Adapting the dimming speed in relation to the dimming function

The channel output is triggered differently depending on the incoming telegram type (according to the assigned communication object) and the set parameters.

The control unit (or the application) provides different functions for controlling the outputs. The way in which this dimming function operates will be described in the following chapters.

The dimming speed can be changed depending on the dimming function. You can change the dimming speed by reducing the dimming time. The different dimming time reductions for the different dimming functions are combined into sets. You can define four sets.

You can select which set is to be used via the set object. After initialising, set "0" is always active. The other sets must be enabled beforehand.

Tab	Parameter
X: Dimming time reductions	Sets 1 to 3

If the set object receives a value between "0" and "3", the respective set is activated. Values outside of this range (invalid values) will cause set "0" to be activated.

Each set has six dimming time reductions available which, depending on the dimming function or type of telegram, can influence the dimming curve for:

- Switching telegrams (switch object and central switch object), switch on the staircase lighting
- Dimming telegrams (dimming object and central dimming object)
- Switching off the staircase lighting
- Value telegrams (value object and central value object)
- Scene telegrams
- Higher-level functions (logic operation, priority operation or disable function)

Tab	Parameter
X: Dimming time reductions	Sets 0 to 3: Dimming time reduction for switching telegrams and switching on staircase lighting at
	Sets 0 to 3: Dimming time reduction for dimming telegrams at
	Sets 0 to 3: Dimming time reduction for switching off staircase lighting at
	Sets 0 to 3: Dimming time reduction for value telegrams at
	Sets 0 to 3: Dimming time reduction for scene telegrams at
	Sets 0 to 3: Dimming time reduction for higher-level functions at

You can use these parameters to modify the dimming speed (based on the basic dimming curve) for a large number of solutions. Some examples:

- Faster dimming brighter and darker when switching ON and OFF: dimming time reduction for switching telegrams and switching on staircase lighting at 50%.
- Faster dimming up and slower dimming down of the staircase lighting: dimming time reduction for switching telegrams and switching on staircase lighting at 30%, and dimming time reduction for switching off staircase lighting at 70%.
- Slower dimming up and down for value dimming: dimming time reduction for value telegrams at 80%.
- Faster setting of the scene values: dimming time reduction for scene telegrams at 40%.



With a set value of 100% or 225, the actual dimming curve precisely corresponds to the basic dimming curve.



The values for "Switching off staircase lighting" only have an influence when no cut-out warning has been parameterised; see the section "Staircase lighting function".

### Adapting the dimming speed using the "Dimming time reduction object"

When the dimming time reduction object is activated, the communication object "Dimming time reduction object" appears.

Tab	Parameter
X: Dimming time reductions	Dimming time reduction object

If the "dimming time reduction object" receives a valid object value between 1 and 255, the dimming time will result from: (Parameterised dimming time to date) x (value of "Dimming time reduction object") / 255.

e.g.

Dimming time parameterised to date = 20 s

Value of "Dimming time reduction object" = 25

=> Dimming time = 20 x 100 / 255 = 7.8 s

# Universal dimming 3211/1.0

## Functional change while a dimming function is being executed

If the application receives a telegram for another dimming function while a dimming function is running, the parameters for the new dimming function will be used immediately. The following illustrates an example of this principle.

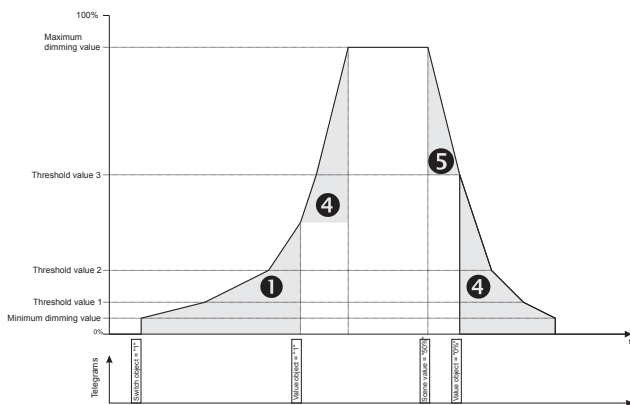

Image legend:

- 1: Dimming time reduction for switching telegrams and switching on staircase lighting.
- 4: Dimming time reduction for value telegrams.
- 5: Dimming time reduction for scene telegrams.

## Communication objects

You can select the following communication objects:

### Per input:

Function	Object name	Type	Prio	Flags	Behaviour
Channel X Dimming time reduction object for dimming curve	Dimming time reduction object	1 byte	Low	WC	Transmit/receive
Channel X sets 1-3	Set object	1 byte	Low	WC	Transmit/receive

## ● "Same dimming time" function

As we have seen earlier in this section, different lamps can have different dimming curves. The dimming speed is thus also different for these lamps, i.e. the time for going through the dimming range until the required dimming value is reached. Often, different lamps are combined together in a scene or a central function. If a function of this type is activated, the entire group of lamps begins to dim to the required value. Depending on the type of luminaire and the scene value, some lamps will reach the retrieved value earlier, others later. This effect will also arise when the luminaires addressed when a scene is activated have different brightness values.

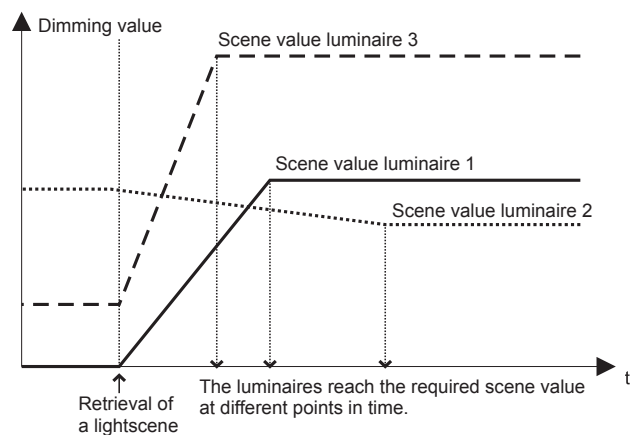

The "Same dimming time" function can be used to synchronise the different dimming times of the channels in such a way that all channels reach their setpoint value at the same time. Using the "Time factor modifiable via the bus" parameter (via the communication object "Factor same dimming time"), the dimming times can also be synchronised for several dimming actuators.

**i** The "Same dimming time" function is only used in connection with scenes and the central function. If no scene or central function has been activated, the parameters for the same dimming time will have no effect.

For the basic dimming curve, an offset factor is calculated when a scene or central function is retrieved, depending on the current output value and on the required function value. The basic dimming curve is extended or compressed, so that all the assigned luminaires reach the required function value at the same time.

# Universal dimming 3211/1.0

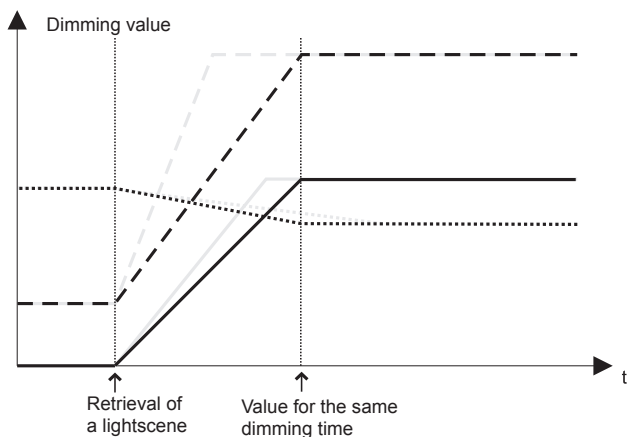

You can release the function globally for the device via a parameter, and set the corresponding dimming time after release:

Tab	Parameter
General	Same dimming time with central function and scenes

If the "Same dimming time" parameter has been activated, you can set the required dimming time in the "Same dimming time" tab and specify whether the time factor should be modifiable via the bus:

Tab	Parameter
Same dimming time	Time base for same dimming time
	Time factor for same dimming time 1 - 255
	Time factor modifiable via the bus

If you have activated the parameter "Time factor modifiable via the bus", a new communication object will now appear with the designation "Factor same dimming time". This object is now used to set the required time. In this case, the "Factor for same dimming time" parameter is only used for setting the time after a bus reset or download. As soon as the "Factor same dimming time" object has been described with a value for the first time, this value will be used to set the time.

The assignment of the individual channels to the "Same dimming time" function is carried out individually for each channel for the scene function and central function.

**i** The dimming time reduction object and dimming time reduction sets are not taken into account for scenes and the central function for the duration of the same dimming time!

If ON or OFF delays have been parameterised, these delay times will be taken into account when the offset factor is calculated, but will not be modified. These delay times retain their set value. Only the gradient of the dimming curve, and thus the dimming speed, is modified.

Example:

Current output status: switched off,  
 ON delay = 1 s,  
 Same dimming time = 5 s,  
 Retrieval of central function with output value 100%  
 With the basic dimming curve, the output channel requires 8 s in order to dim from the OFF status to 100%. Including the ON delay of 1 s, this gives 9 s.

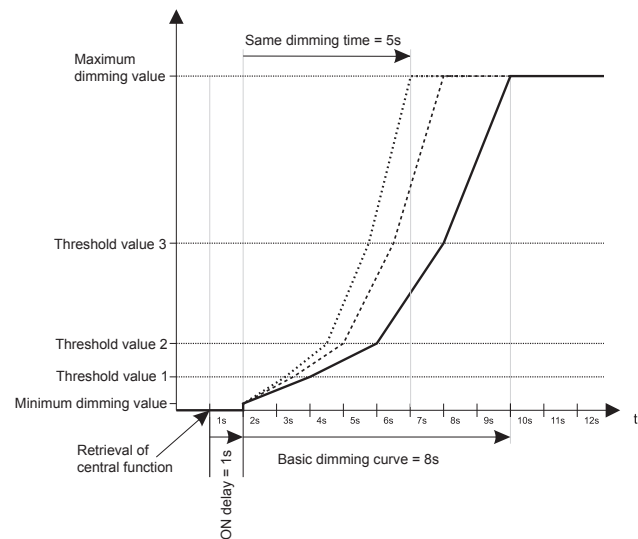

The ON delay is also retained even with a "same dimming time". The dimming curve is compressed or extended in such a way that the dimming value is reached after the same dimming time. In other words, calculation of the new dimming curve takes into account the pure dimming time (the same dimming time minus ON delay time).

**i** The set dimming time must be larger than 1 second and may not be smaller than any set ON and OFF delays with the individual output channels. If this is not the case, the same dimming time is ignored and the dimming curves will be executed normally with the time factors and dimming time reduction sets.



# Universal dimming 3211/1.0

## Communication objects

You can select the following communication objects:

### Per input:

Function	Object name	Type	Prio	Flags	Behaviour
Same dimming time	Factor same dimming time	1 byte	Low	WC	Transmit/receive

### ● Priorities

The functions of the application have different priorities in relation to their processing:

High priority

3	Disable function
2	Logic operation or priority operation
1	Switching, dimming, value dimming, time functions, scenes, central function

Low priority

#### Priority group 1:

In priority group 1, all functions have an equal status, i.e. they can be overwritten by other functions. A function which is currently active is ended when a new control telegram with the same priority is received. New set values for the scene function, the time functions or the central function act in the same way as an update for the "Switch object" of an output channel in relation to the specification of the priority.

#### Priority group 2:

When a function from priority group 2 is activated, the dimmer output is triggered according to the now active output value. The function values for priority group 1 are overwritten and are no longer forwarded to the output, as long as the priority function is active. However, all control functions in priority group 1 continue to be calculated and updated in the background.

You can determine the reaction of an output after deactivation of priority operation via a parameter (see the chapter in the manual on the priority operation function). After a logic operation function has been deactivated, the output is always set to the current output value which the device has calculated in the background.

#### Priority group 3:

The disable function with the highest priority level 3 overrides all other functions. The functions in priority levels 1 and 2 also continue to be evaluated in the background here, however, so that after the disable function has been deactivated, the dimmer output can be set to the current required value, or can adopt a status for which the parameters have been set. You can also determine this output behaviour via a parameter in the same way as for priority operation (see the chapter in the manual on the disable function).



Please note that any function changes can also lead to changes in the dimming curve and thus the dimming speed (see also the section on "dimming speed" earlier in this manual).

### ● Basic functions

The software application provides three basic functions for controlling the brightness of the connected luminaires: switching, relative dimming and value dimming.

For each output channel which you have activated via parameters, three communication objects for controlling these basic functions will appear:

Tab	Parameter
X: General	Channel X

If you have set the parameter "Channel X" to the value "activated", the following objects appear:

- for the "Switch" function: "Switch object", length: 1 bit
- for the "Relative dimming" function: "Dimming object", length: 4 bit
- for the "Value dimming" function: "Value object", length: 1 byte

You will also find additional setting parameters on the parameter tab for specifying how the dimming output should function.

## Universal dimming 3211/1.0

### Switch function (1 bit)

If the "Switch object" receives a telegram with the value "1", the output will be "switched on" and the dimming time reduction sets and the dimming time reduction object, if required, will be activated according to the basic dimming curve and the dimming time reduction "For switch telegrams and staircase lighting switch on". The output is "switched off" with the object value "0". In this case, the dimming curve is run through in reverse (from the maximum value to the minimum value); in other words, it is dimmed down.

You can use parameters to specify the maximum value that is activated:

Tab	Parameter
X: General	Starting behaviour

#### Settings:

-Max. brightness: The output channel is set to the value which you have set in the parameter "Maximum dimming value in %".

-Selectable brightness: With this value, an additional setting parameter appears:

Tab	Parameter
X: General	Initial brightness in %

The output is switched on to the set ON brightness with a "1" telegram. The initial brightness value should not exceed the maximum dimming value, since this always limits the maximum output brightness and is also set when you select a higher value for the parameter.

-Last brightness value (memory): After a "1" telegram, the output is reset to the last brightness value it had before switching off. After a download or bus voltage failure, the value which is defined as the maximum dimming value will be set here.

### Relative dimming function (4 bit)

You can use the "Relative dimming" function to dim the output brighter or darker relative to its current value. The step sizes of the brightness change and the dimming direction are determined by the telegram value.

Telegrams for the "Relative dimming" function are received via the "Dimming object" object

After a relative dimming telegram has been received, a new set value is calculated from the current value, the dimming direction received and the step size received.

Example (minimum dimming value = 10%, maximum dimming value = 90%, current output value = 12%):

Dimming brighter telegram with a step size of 25%  
=> New set value: 12% + 25% = 37%

Dimming darker telegram with a step size of 12.5%  
=> New set value: 37% - 12.5% = 24.5%

The "Minimum dimming value" and "Maximum dimming value" limit values must not be crossed with relative dimming.

You can use a parameter to determine the other functions of an output channel when a relative dimming telegram is received:

Tab	Parameter
X: General	Dimming object switches channel

#### Settings:

-Not: This parameter setting prevents switching on and off, i.e. the channel remains off, or at the minimum dimming value.

-Only on, not off: The output channel can only be switched on by relative dimming telegrams. If it is switched on and the set value fails to reach the minimum dimming value via relative dimming telegrams, the output remains switched on at the minimum dimming value.

-Only off, not on: The output channel cannot be switched on by relative dimming telegrams. If it is switched on and the set value fails to reach the minimum dimming value via relative dimming telegrams, the output remains switched off.

-On and off: The output channel can only be switched on by relative dimming telegrams. If it is switched on and the set value fails to reach the minimum dimming value via relative dimming telegrams, the output remains switched off.

## Universal dimming 3211/1.0

### Value dimming function (1 byte)

The "Value dimming" function is used when you want to set the required brightness directly. To do this, send the required brightness value to the "Value object" of the output channel as a percentage between 0% and 100%. The value range is divided into 255 brightness levels. A level has a step width of approximately 0.4%. The telegrams for dimming with absolute values have the 1-byte data format.

The required brightness values must lie within the limits which are specified by the minimum and maximum dimming values. If the brightness value exceeds the maximum dimming value, the maximum dimming value will be set as the output value. If the brightness value is lower than the minimum dimming value, this will be set as the output value.

You can complete the settings for switching the dimming output on and off via the "value dimming" function using a parameter:

Tab	Parameter
X: General	Value object switches channel

Settings:

-Not: This parameter setting prevents switching, i.e. the channel remains at the current value.

-Only on, not off: The output channel can only be switched on by value telegrams. If it is switched on and the "Value object" receives the value 0%, the output remains switched on at the minimum dimming value.

-Only off, not on: The output channel cannot be switched on by value telegrams. If it is switched on and the "Value object" receives the value 0%, the output remains switched off.

-On and off: The output channel can be switched on by value telegrams. If it is switched on and the "Value object" receives the value 0%, the output remains switched off.

### Communication objects

You can select the following communication objects:

Per input:

Function	Object name	Type	Prio	Flags	Behaviour
Channel X General	Switch object	1 bit	Low	WC	Transmit/ receive
Channel X General	Dimming object	4 bit	Low	WC	Transmit/ receive
Channel X General	Value object	1 byte	Low	WC	Transmit/ receive

### ● Advanced functions

The advanced functions are the functions of the software application which share the same priority as the basic functions "Switch", "Relative dimming" and "Value dimming" (for more on this topic, see the section on priorities). The advanced functions are: time functions (ON/OFF delay, staircase timer), scenes and a central function. Any update of one of the basic functions or an advanced function overwrites the current status, and sets the dimming output according to the last function value received.

### Time functions

#### Delay functions

The delay functions delay the switching on or off of an output channel. They are switched upstream or downstream in relation to the actual output functions, i.e. they delay the execution of the requested output command.

The delay functions affect the basic functions and the advanced functions. The higher-level functions are always effective immediately and without a delay.

The dimming curve with the delay functions follows the basic dimming curve and the current dimming curve reduction of the current dimming curve reduction set and, when appropriate, the dimming curve reduction object (please refer to the earlier section on "Dimming speed").

You can select the delay functions for each channel via a parameter:

Tab	Parameter
X: General	Delay times

When you have enabled the delay functions for an output channel, a new parameter card will appear for this channel for activation and to allow you to make detailed settings for the functions.

– ON delay

The ON delay becomes active when the output is currently switched off, and is now set to be switched on via a new telegram for a basic function or an advanced function.

If you wish to use the ON delay, you must activate the function:

Tab	Parameter
X: Delay times	ON delay

# Universal dimming 3211/1.0

Settings:

-Deactivated: The ON delay is not active.

-Retriggerable: If the channel receives an ON telegram, the ON delay will be started. If a new ON telegram now follows while the delay time is running, the delay time will be restarted. The value of the new telegram is set as the new set value which is activated after the delay period has expired. If the new value is the "STOP dimming" value for relative dimming, the output value will be set to the minimum dimming value after the delay period has expired.

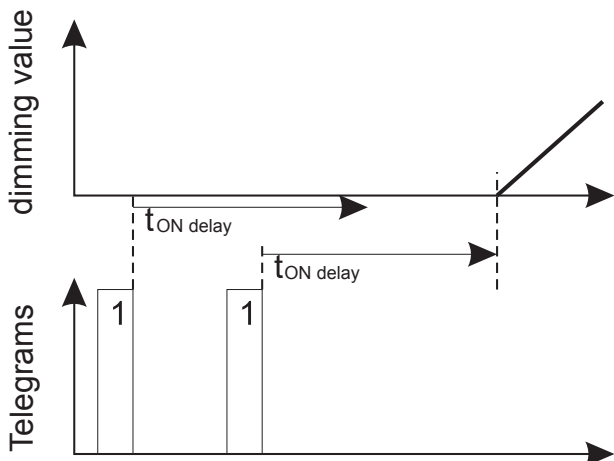

-Not retriggerable: If the channel receives an ON telegram, the ON delay will be started. If a new ON telegram now follows while the delay time is running, this will be ignored and the ON procedure executed after the delay time initially started has expired. The value of the new telegram is however set as the new set value which will be activated after the delay period has expired. If the new value is the "STOP dimming" value for relative dimming, the output value will be set to the minimum dimming value after the delay period has expired.

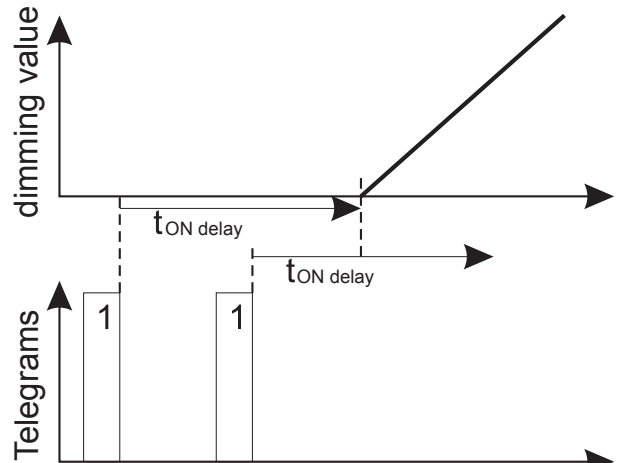

If the channel receives an OFF telegram while an ON delay is active, the ON delay will be interrupted.

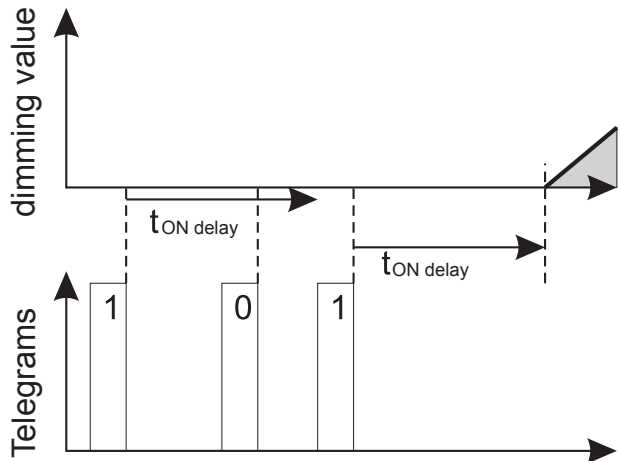

You can use a parameter to set whether the output channel remains switched off during the ON delay, or whether it is already set to the minimum dimming value.

Tab	Parameter
X: Delay times	Output during the ON delay

The specific delay time for the ON delay is obtained as the product of the time base and the factor; the default values result in an ON delay of 3 seconds.

Tab	Parameter
X: Delay times	Time base for ON delay
	Time factor for ON delay (1 - 255)

## Universal dimming 3211/1.0

### – OFF delay

The OFF delay becomes active when the output is currently switched on, and is now set to be switched on via a new telegram for a basic function or an advanced function.

Please note: The OFF delay is not effective with relative dimming commands in a negative dimming direction, since these are not specific OFF commands.

If you want to use the OFF delay, you must activate the function:

Tab	Parameter
X: Delay times	OFF delay

### Settings:

-Deactivated: The OFF delay is not active.

-Retriggerable: If the channel receives an OFF telegram, the OFF delay will be started. If a new OFF telegram now follows while the delay time is running, the delay time will be restarted.

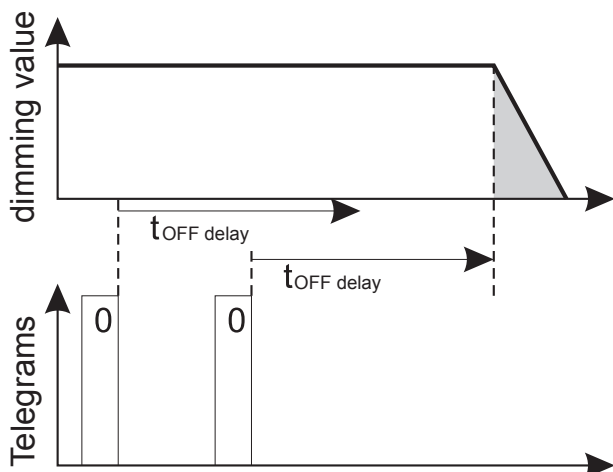

-Not retriggerable: If the channel receives an OFF telegram, the OFF delay will be started. If a new OFF telegram now follows while the delay time is running, it will be ignored and the OFF procedure executed after the delay time initially started has expired.

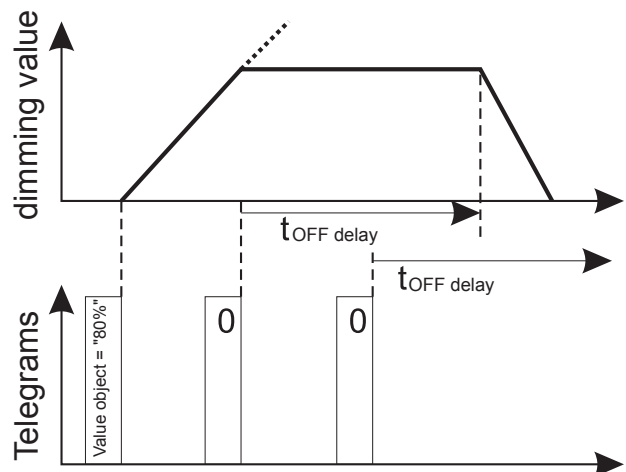

If the output receives a new telegram while an OFF delay is active, which creates an ON status, the OFF procedure will be halted and the new setpoint value set.

If the output is conducting a dimming procedure when an OFF telegram is received, this dimming procedure will be stopped. The output remains in the current dimming value for the duration of the OFF delay, before it switches off after the delay has expired (see the chart for the "not retriggerable" setting").

If a staircase lighting function with manual OFF is active, the output will not be switched off immediately by a manual OFF command, but only when the set delay time has expired (please also refer to the following section on the staircase lighting function).

The specific delay time for the OFF delay derives from your settings as a product of the time base and the factor:

Tab	Parameter
X: Delay times	Time base for OFF delay
	Time factor for OFF delay (1 - 255)

With the standard values, an OFF delay of 3 seconds is produced.

## Universal dimming 3211/1.0

### ● Staircase lighting function

The staircase lighting function offers you the option of switching on a dimmer output with a telegram in such a way that this output switches itself back off automatically after a specified time has expired, without a new control telegram. Since this function is often used to control the lighting in staircases, it is named accordingly.

The dimming curve of the staircase lighting function follows the respective dimming curve reduction of the current dimming curve reduction set and, when appropriate, the dimming curve reduction object (for more information on the dimming time reduction set, please refer to the earlier section on "Dimming speed").

**i** Note that different dimming speeds may be present for the ON and OFF procedures.

**i** The staircase timer only begins when the output channel has reached the final dimming value after dimming up. The dimming time is therefore not included in the staircase timer. The dimming value during the staircase timer is the (parameterised) maximum dimming value.

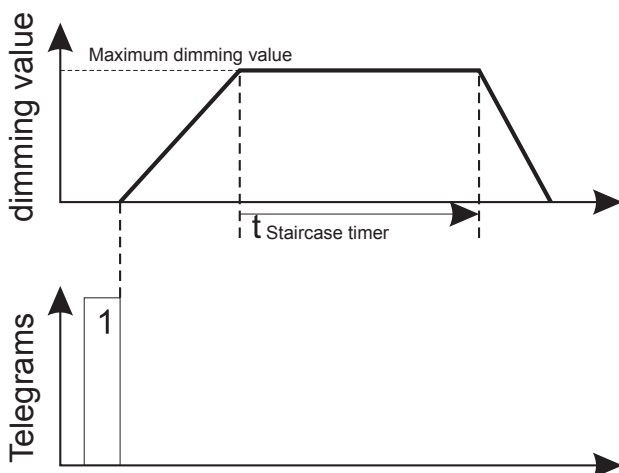

You can activate the staircase lighting function for a channel via a parameter:

Tab	Parameter
X: General	Staircase lighting function

When you have activated the staircase lighting function for an output channel, a new parameter window and a new communication object labelled "Staircase lighting object" will appear for this channel. The "Staircase lighting object" has a 1-bit format. The staircase lighting function is controlled via the received telegram values of the "Staircase lighting object".

You can set the time duration for the staircase timer via the time base and time factor:

Tab	Parameter
X: Staircase timer	Time base, staircase timer
	Time factor for staircase timer (1 - 255)

The period of time is the product of your setting for the time base and factor. The default values therefore result in a staircase timer of 3 minutes.

If the "Staircase lighting" object receives a telegram with the value "1", the dimmer output will be switched on and be dimmed to the max. dimming value, remaining at this value for the set "Staircase timer", after which the output channel then dims automatically to the value 0%.

**i** Note: During the staircase timer, you can modify the output brightness using dimming telegrams via the "Dimming" or "Value object" objects. If the output fails to reach its minimum dimming value due to these dimming telegrams, or if the value object is described with the value "00h", the parameter settings for the OFF behaviour of these functions will apply.

You can use the "Staircase lighting function" parameter to specify whether an active staircase lighting function can be manually interrupted or not:

Tab	Parameter
X: Staircase timer	Staircase lighting function

The individual settings have the following meaning:

- with manual OFF,... / without manual OFF,... : You can initially specify whether an active staircase lighting function can be manually interrupted (= "with manual OFF") or not (= "without manual OFF").

If you have set the parameter to the value "with manual OFF", the output will be switched off when the "Staircase lighting" object receives a telegram with the value "0".

**i** Note: "Manual OFF" does not refer to switching off the extension units manually with the manual keys on the device, but means switching off via an KNX telegram.

# Universal dimming 3211/1.0

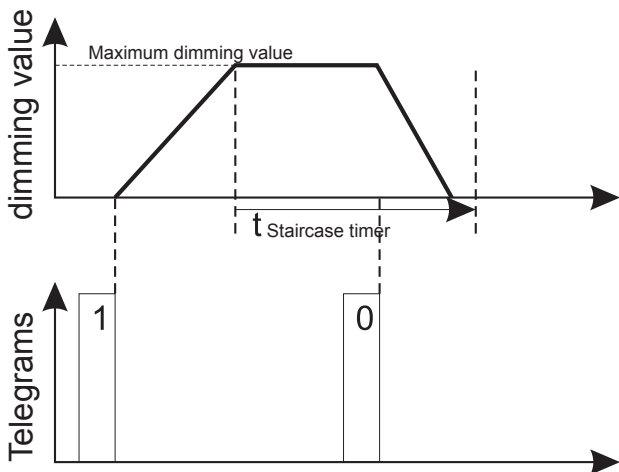

If an OFF delay has been parameterised, this function will now be active and the output will only switch off after the delay time has expired.

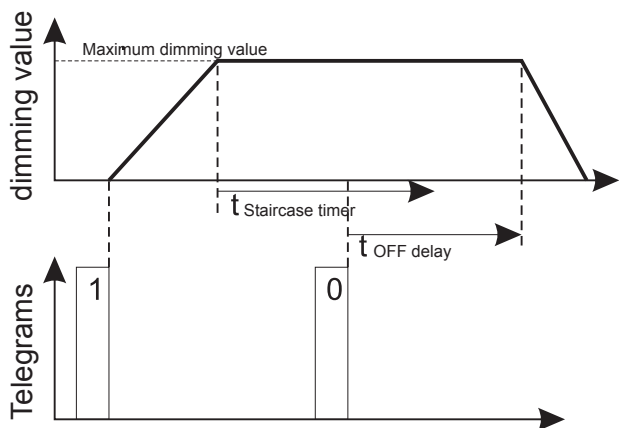

If you have selected the parameter value "without manual OFF", the staircase lighting function will not be interrupted when a telegram with the value "0" is received, but will continue to run normally until the staircase timer has expired.

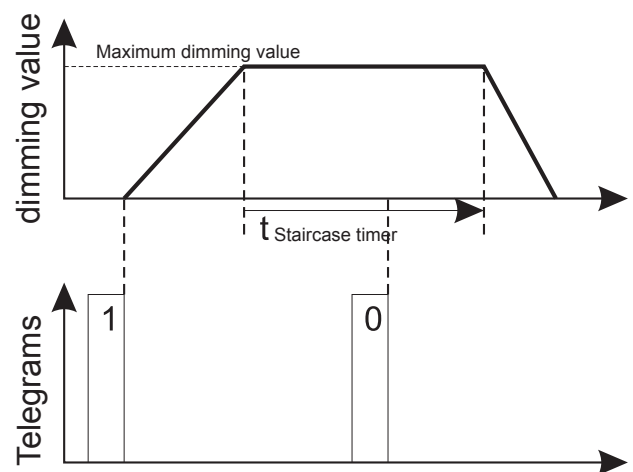

- ..., not retriggerable: With this setting, the staircase lighting function which was started initially proceeds normally, even when additional "1" telegrams are received during the staircase timer.

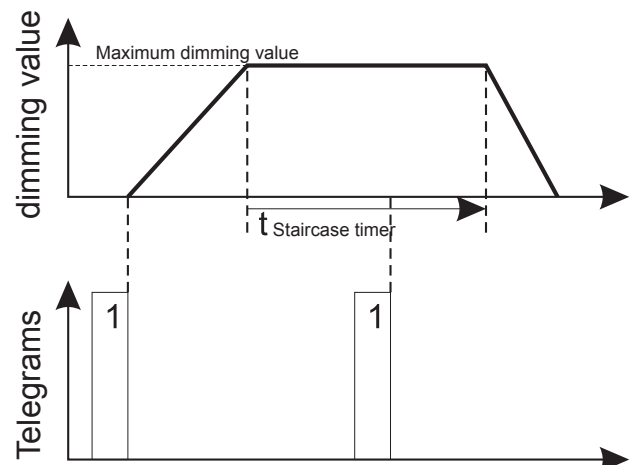

- ..., retriggerable: If the "Staircase lighting" object receives an additional "1" telegram while a staircase lighting function is active, the staircase timer will be restarted. This occurs when a "1" telegram is received while the function is active.

# Universal dimming 3211/1.0

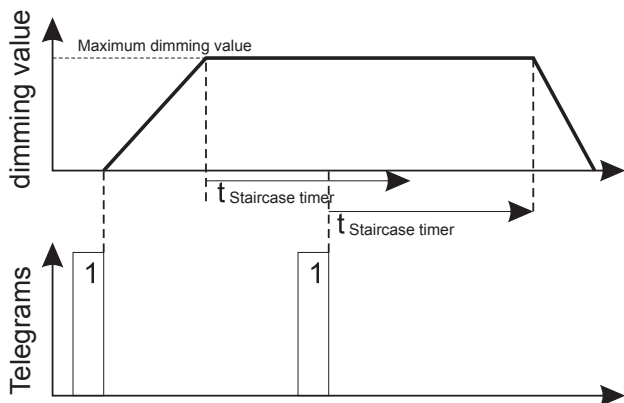

- ..., summing up time: If the "staircase lighting" object receives a second start signal a ("1" telegram) while a staircase lighting function is active, the active staircase timer will be doubled. With a third start signal, the staircase timer will be tripled, and with the fourth start signal, quadrupled. The actual staircase timer therefore results from the staircase timer being multiplied by the number of start signals received. The maximum possible running time for this function is 255 hours.

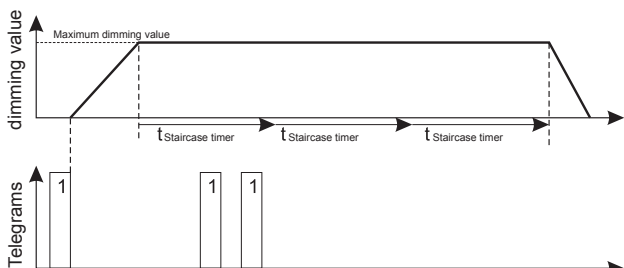

You can limit the potential running time using the "Max. number of time accumulations" parameter.

Tab	Parameter
X: Staircase timer	Max. number of time accumulations (2 - 255)

If the staircase timer has expired, the dimming output will be dimmed down and switched off according to the settings for the dimming speed and the current speed set. You can however use the "Cut-out warning" function to influence the dimming-down behaviour over time at the end of a staircase lighting function:

Tab	Parameter
X: Staircase timer	Cut-out warning for staircase timer
	Warning time for staircase timer in seconds (1 - 255)

If you have activated the cut-out warning, you can set a "Warning time" as a time period between 1 s and 255 s (= 4 min 15 s). This "Warning time" determines how long the dimming-down procedure should last. The active values for the dimming speed and the dimming time reduction sets are no longer taken into account in this case. The dimming curve is extended or compressed to the set warning time while dimming down.

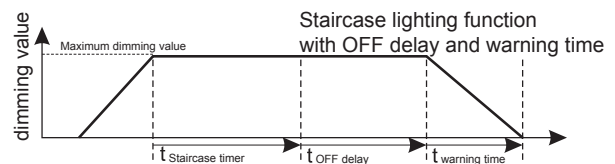
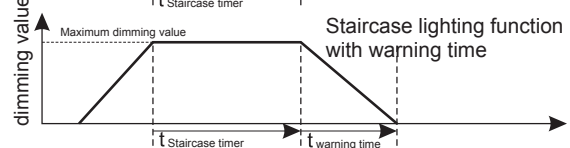
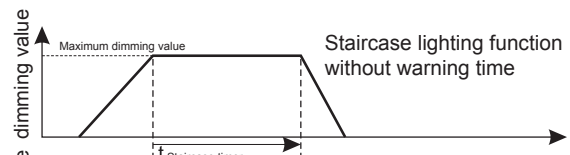

Regardless of which dimming value the output has after the staircase lighting function has expired, the time duration for the dimming-down procedure always corresponds to the warning time when the cut-out warning is active.

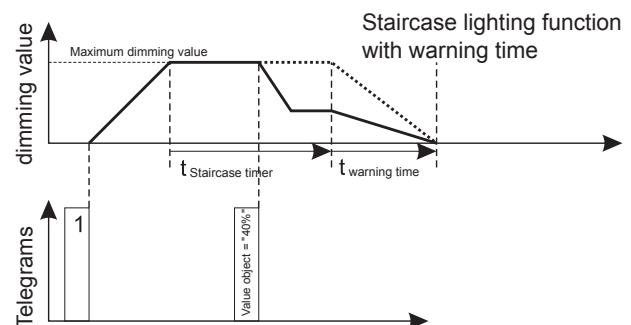

If you have parameterised a cut-out delay for the dimmer output, the warning time will begin after the delay period has expired.

**i** After the staircase timer has elapsed, a new staircase lighting function sequence will be started when a new "1" telegram is received on the "Staircase lighting" object even if the output is still dimming down or a warning time is active. At this point in time, a "1" telegram is therefore no longer valid as a trigger signal for restarting the staircase timer, or for accumulating the staircase timers.



# Universal dimming 3211/1.0

## ● Logic operation between the switch object and the staircase lighting object

To control a dimming output, its switch object is connected with its staircase lighting object by a logical OR operation.

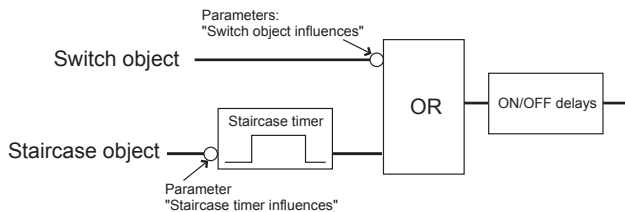

You can invert, or not invert, the effect of the two object values on this logic operation using parameters:

Tab	Parameter
X: General	Switch object influences
X: Staircase timer	Staircase lighting object influences

If you set the parameter value to "not inverted", the logic operation is formed with the current object value; object value "0" remains "0" and object value "1" remains "1".

If you set the parameter value to "inverted", the logic operation is formed with a value which is opposite to the current object value; Object value "0" becomes "1" and object value "1" becomes "0".

You can overwrite a staircase lighting function in progress using a telegram for the switch object. In this case, the staircase lighting function continues to run normally in the background.

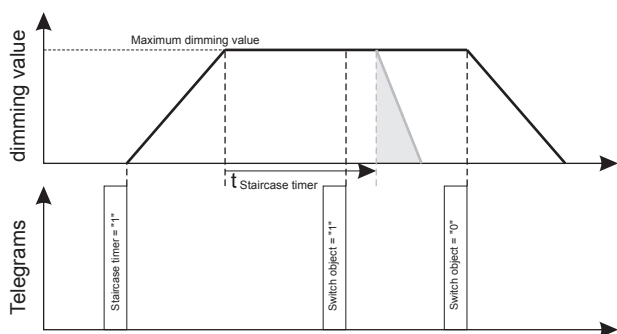

The brightness of the logic operation result and the dimming speed is defined by the last telegram (see the charts below).

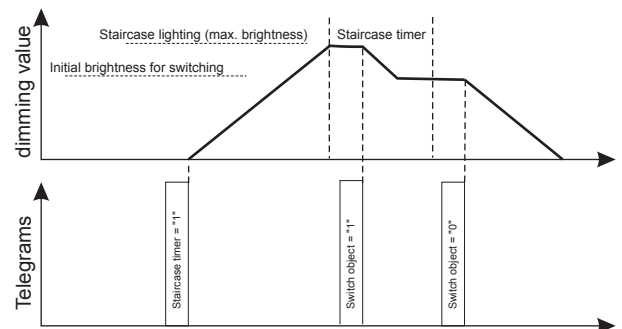
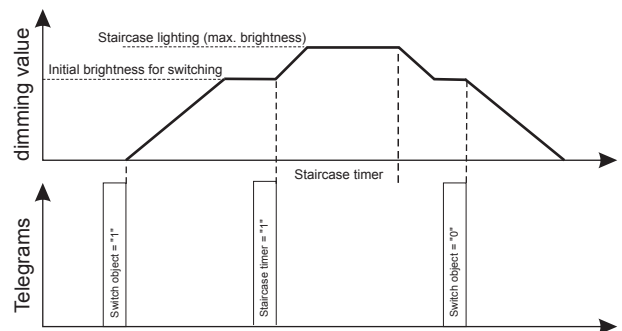

You can use this, for example, for temporary continuous light switching (cleaning lighting). An ON telegram from the switch object causes the light in the staircase lighting function to remain switched on continuously. Value, dimming, scene and central telegrams continue to be effective, however. For an application of this type, an initial brightness of 100% would be useful.

Another application would be a staircase lighting function with a continuous basic brightness (e.g. in hospital corridors). To do this, the required basic brightness is parameterised as the initial brightness and the staircase lighting function is switched e.g. via a movement detector.

**i** See also the section "Logic operation" in relation to this topic.

## Communication objects

You can select the following communication objects:

### Per input:

Function	Object name	Type	Prio	Flags	Behaviour
Channel X Staircase lighting object	Switch object	1 bit	Low	WC	Transmit/ receive

## Universal dimming 3211/1.0

### ● Scenes

You can use the scene functions when you wish to give the user the option of modifying different room functions simultaneously via just one bus telegram. Retrieving a room scene allows you, for example, to dim the room lighting to a required value, move the blinds into a required position, set the heating control to daytime operation and switch on the power supply to the socket-outlets in a room. Since these functions not only have different telegram formats but the telegram values can have different meanings (e.g. value "0" means OFF for lighting and OPEN for blinds), without the scene function you would have to send a separate telegram to each actuator to achieve the same setting.

The scene function allows you to integrate the dimming actuator into a scene control. There are memory slots for up to 8 different scene values for each output channel. Each of these 8 scene memories can be assigned to one of 64 possible scene numbers (0 to 63). You can store the brightness value in % as scene values. If the dimming actuator receives a telegram which retrieves a scene number, the assigned output channel will be dimmed to the saved brightness. The brightness values for the individual scenes which you save while commissioning can be overwritten later by the user as he requires.

**i** If the learn bit in a telegram has the value "0", the brightness values saved for this scene number will be retrieved and the dimmer outputs set accordingly.  
If the learn bit has the value "1", then the current brightness values of the assigned dimming outputs will be saved as new scene values for the transmitted scene number.

Activating the scene function:

In order to be able to use the scene function for the individual dimming channels, you first have to priority enable the function for the device:

Tab	Parameter
General	Scenes

If you have set the "Scenes" parameter to the activated value the communication object "Scene object" which can now receive scene telegrams will appear.

Now you can activate the scene function for each channel individually:

Tab	Parameter
X: General	Scenes

If you have activated the "Scenes" parameter of an output channel, a new parameter window in which you can set the scene values will appear for this channel. You can activate each of the eight scene memories separately:

Tab	Parameter
X: Scenes	Scene 1 to scene 8

You can assign a scene number (0 - 63) to each of the activated scenes and set a brightness value:

Tab	Parameter
X: Scenes	Scene 1 to scene 8 scene numbers (0 - 63)
	Scene 1 to scene 8 brightness value in %

When setting the brightness values, observe the limits set by the minimum and maximum dimming values.

Retrieving scene values:

The "Scene object" allows you to retrieve stored brightness values. After receiving a telegram, the transmitted scene number is evaluated. If one of the eight scene memories has been assigned to this scene number, the stored brightness value will be set.

**i** If several of scene memories 1 to 8 have been assigned to the same scene number, the first memory value will be activated.

Saving scene positions:

When the "Scene object" receives a new telegram in which the learn bit has the value "1", the current dimming value will be saved as the new brightness value in the first scene memory which is assigned to the received scene number.

## Universal dimming 3211/1.0

Example:

Output channel 1

Scene 1 activated at scene number 13  
(Scene 1 brightness = 50%)

Scene 2 activated at scene number 7  
(Scene 2 brightness = 30%)

Scenes 3 to 8 deactivated

Output channel 2

Scene 1 activated at scene number 7  
(Scene 1 brightness = 90%)

Scene 3 activated at scene number 21  
(Scene 3 brightness = 50%)

Scenes 2 and 4 to 8 deactivated

Retrieve scene number 13)

=> Output channel 1 dims to 50%

=>Output channel 2 does not respond

Retrieve scene number 1

=> Actuator does not respond because scene number 1 is not assigned.

Retrieve scene number 7

=> Output channel 1 dims to 30%

=> Output channel 2 dims to 90%

Retrieve scene number 21

=>Output channel 1 does not respond

=> Output channel 2 dims to 50%

Outputs are manually dimmed to the new values:

Output channel 1: Brightness = 70%

Output channel 2: Brightness = 20%

Program scene number 13

=> Output channel 1: Scene 1 Brightness value = 70%

=> Output channel 2: does not respond, since scene number 13 has not been assigned.

Retrieve scene number 13

=> Output channel 1 dims to 70%

=>Output channel 2 does not respond

Note the difference from the first retrieval of scene number 13 above!

If you activate the parameter "Replace scene values in the actuator on download", then the scene values programmed during operation which are stored in the device for this channel will be replaced with your preset values on download. If you don't want to overwrite the values in the device when downloading, then you must disable this parameter:

Tab	Parameter
X: Scenes	Overwrite scene values in the actuator during download

Same dimming time for scene function

The general information section in this manual on "Dimming speed" contains an explanation of the "Same dimming time" function. You can assign the scene functions of an output channel to this function via a parameter:

Tab	Parameter
X: Scenes	Same dimming time

Extension unit function for scenes

This function allows you to also activate or re-program the scene values for the scene memories 0 to 3 also using 1-bit telegrams. The extension unit function is activated once for the device:

Tab	Parameter
General	Extension unit scenes

If you have enabled "Extension unit scenes", the additional communication objects will appear with the 1-bit data format:

"Retrieve scene 1/2", "Retrieve scene 3/4",

"Save scene 1/2", "Save scene 3/4".

You can also use these objects to retrieve scenes 1 to 4 or to re-program them:

"Retrieve scene 1/2"" = "0": Scene number 0 is activated

"Retrieve scene 1/2"" = "1": Scene number 1 is activated

"Retrieve scene 3/4"" = "0": Scene number 2 is activated

"Retrieve scene 3/4"" = "1": Scene number 3 is activated

"Save scene 1/2" = "0": Scene number 0 is programmed

"Save scene 1/2" = "1": Scene number 1 is programmed

"Save scene 3/4" = "0": Scene number 2 is programmed

"Save scene 3/4" = "1": Scene number 3 is programmed

The actions correspond to a normal retrieval or program command for scene numbers 0, 1, 2 or 3 using the "Scene object". The extension unit function is not available for scene numbers 4 to 63. You can only address these scene numbers using the "Scene object".

# Universal dimming 3211/1.0

## Communication objects

You can select the following communication objects:

### Per input:

Function	Object name	Type	Prio	Flags	Behaviour
Scenes	Scene object	1 byte	Low	WC	Transmit/ receive

### ● Central function

You can use the central function to switch or dim several output channels simultaneously with a telegram command. This function is useful, for example, when you switch off all the lamps at the press of a button when leaving your house, and when you wish to switch on a certain group of lights at the press of a button when you return home. Another example application for the central function would be to set the lights at the press of a button to a low dimming value on the way to the bathroom, in order not to wake other people in the house.

If you wish to use the central function for one or more output channels, you will need to priority enable the function for the device:

Tab	Parameter
General	Central function

Activating the central function for the device make three new communication objects available, which you can in turn activate or deactivate individually using parameters:

Tab	Parameter
General	Central switch object
	Central dimming object
	Central value object

The activated objects appear as new communication objects "Central switch object", "Central dimming object" and "Central value object" after they have been activated.

## Assigning the output channel to the central function:

You can select the assignment of an output channel to the central function individually for each channel when parameterising:

Tab	Parameter
X: General	Central function

If you have assigned a channel to the central function, the output value of this dimming output can be controlled not only via the channel-specific switching, dimming or value objects (see the "Basic functions" section), but also via the enabled objects in the central function. The central function controls the entire assigned group of channels simultaneously.

### Switching via a central object:

After the central function for an output channel has been activated, a new parameter window will appear for this channel. In this parameter window, you can specify how the assigned channel should respond when a new telegram value is received via the "Central switch object":

Tab	Parameter
X: Central function	Function at central switching value = 0
	Function at central switching value = 1

First select how the output should react when a new object value is received for the central object. If you wish to set a variable brightness, you can specify the required values in additional setting parameters:

Tab	Parameter
X: Central function	Required brightness at central switching object = 0 in %
	Required brightness at central switching object = 1 in %

Note that the set values in each case fall within the limits set by the minimum and maximum dimming values.

### Relative dimming and value dimming via the central function

The two dimming functions in the central function operate in the same manner as the corresponding basic functions (see also the section "Basic functions").

With these functions, the telegrams also affect the entire group of assigned output channels simultaneously. The "Central dimming object" causes relative dimming operations, while the "Central value object" sets a new absolute dimming value for the group.

# Universal dimming 3211/1.0

## Dimming speed of the central function

The dimming speed for operations via the central functions corresponds to the settings for the corresponding basic functions. The dimming time for setting a new brightness value therefore corresponds to the setting for the active dimming reduction set for the switch function, the setting for the active dimming time reduction set for relative dimming and the setting for the active dimming time reduction set for value dimming.

## Same dimming time for central function

The software application also offers you the option of activating the "Same dimming time" function for the central switching and value dimming functions. In this way, all dimming outputs in a channel group which are controlled via the central function reach the required dimming value simultaneously. The settings for the dimming speeds are ignored with this function option (for further information, see the section on dimming speed). You can use a parameter to determine whether an output should also be assigned to the "Same dimming time" function in relation to the central function:

Tab	Parameter
X: Central function	Same dimming time

## ● Higher priority functions

With the logic operation, priority operation and disable functions, the software application provides you three higher priority functions. The functions with higher priority are processed before functions with lower priority.

High priority	
3	Disable function
2	Logic operation or priority operation
1	Switching, dimming, value dimming, time functions, scene, central function

Low priority

Alternatively, you can activate the logic operation or priority operation functions for an output channel using a parameter:

Tab	Parameter
X: General	Higher priority function

You can also use a parameter to activate a disable function with the highest priority for each output channel:

Tab	Parameter
X: General	Disable function

## Logic operation

There is a new object with the label "Logic object" (1 bit) for each output channel you have selected the logic operation as the higher priority function for. The value of this "Logic object" is then logically linked to the value of not only the "Switch object" but also the "Staircase lighting" object of this output channel.

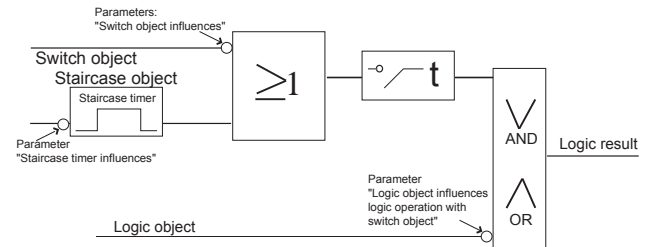

AND and OR functions are optional logic operations:

Tab	Parameter
X: Logic operation	Logic operation

You can use the logic object to "overwrite" the current brightness of a switch or staircase lighting function and to set it to a parametrizable brightness value.

Tab	Parameter
X: Logic operation	Brightness with logic object "0" in % (with AND logic operation)
X: Logic operation	Brightness with logic object "1" in % (with OR logic operation)

With an OR logic operation, the parameterised brightness is specified with an object value "1" and with an AND logic operation with an object value "0".

You can invert, or not invert, the effect of the current object values on this logic operation using parameters:

You can specify the input behaviour for the logic object:

Tab	Parameter
X: Logic operation	Logic object effective

If you set the parameter value to "not inverted", the logic operation will be formed with the current object value; the object value "0" remains "0" and the object value "1" remains "1".

## Universal dimming 3211/1.0

If you set the parameter value to "inverted", the logic operation will be formed with a value which is opposite to the current object value; Object value "0" becomes "1" and object value "1" becomes "0".

**i** The switch object and staircase lighting object are also combined via an OR logic operation when the logic function is inactive (see the "Staircase lighting function" section).

**i** Note the following important special feature: You can also use telegrams for the "Dimming object" and "Central dimming object" (4 bit) or "Value object" and "Central value object" (1 byte) and scene telegrams to modify the brightness value of the dimming output even while a logic function is active. However, the central object cannot be inverted. Here, the output can also be switched on or off, even when you have selected a different behaviour when the logic function is active. Otherwise, an active logic function can only be overridden by the disable function with a higher priority. Each time a telegram is received via the switch object, the central object or the staircase lighting object (before the warning), the logic function will be updated and the logic operation result re-calculated.

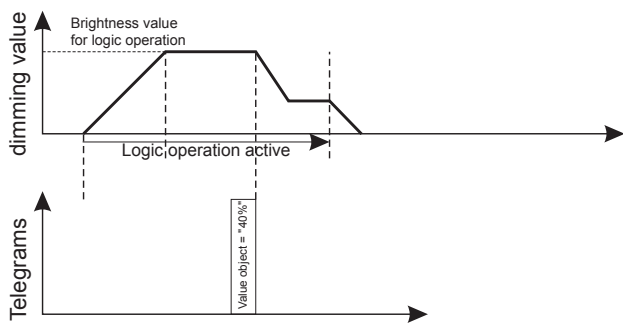

The brightness of the logic operation result and the dimming speed are defined by the last telegram.

If you have activated the logic function, the set value will be activated after downloading or after the bus voltage has returned at the input to the logic functions, and will be effective immediately.

Tab	Parameter
X: Logic operation	Value of the logic object after bus voltage failure and downloading

In this regard see also the section "Startup and failure behaviour".

## Universal dimming 3211/1.0

### Priority operation

If you have selected priority operation for a channel, a new communication object labelled "Priority operation" will be provided for this channel and a new parameter window for additional function settings. The "Priority operation" object has a length of 2 bits, with the following data format:

Bit1	Bit0	Behaviour of the output
1	1	Priority operation, dimming output "on"
0	1	End of priority operation
1	0	Priority operation, dimming output "off"
0	0	End of priority operation

### Activating priority operation:

The priority operation for the output is activated when the value "1" is received on bit1. Depending on bit0 of the received telegram, the assigned dimming output is then set according to your parameter settings:

- For bit0 = "1":

Tab	Parameter
X: Priority operation	Behaviour on start of priority operation "on"

If you wish to set a specific brightness, you can set this brightness via an additional parameter:

Tab	Parameter
X: Priority operation	Required brightness at start of priority operation "on" in %

- For bit0 = "0":

Tab	Parameter
X: Priority operation	Behaviour at start of priority operation "off"

If you wish to set a specific brightness, you can set this brightness via an additional parameter:

Tab	Parameter
X: Priority operation	Required brightness at start of priority operation "off" in %

### Settings at start of a priority operation:

- No response: The dimming output remains at its current brightness value at the start of priority operation. While the priority operation is active this output value can only be changed by the disable function which has a higher priority.
- Switch off: The dimming output is switched off.
- Switch on with selectable brightness: The dimming output is set to the defined brightness value.

### Deactivating priority operation

The priority operated dimming output remains in the selected status until priority operation is enabled again by a new telegram with the value "0" to bit1. You can use parameters to set how a dimming output should respond when priority operation is removed again:

Tab	Parameter
X: Priority operation	Behaviour at the end of priority operation

### Setting options at the end of priority operation:

- No response: The dimming output remains at its current output value until the output receives the next switch or dimming telegram.
- Switch off: The dimming output is switched off at the end of priority operation.
- Switch on with selectable brightness: The dimming output sets the brightness value which you have determined via an additional parameter:
- Follows secondary functions: Telegrams for the secondary functions continue to be processed in the background while a priority operation is active, but are not forwarded to the dimming outputs. After the priority operation, the output is set to the value which has been calculated in the background.

Tab	Parameter
X: Priority operation	Required brightness at end of priority function in %

## Universal dimming 3211/1.0

### Dimming speed of priority operation

The dimming speed for changes in brightness during activation, deactivation and priority operation is influenced by the dimming time reduction for higher priority functions in the current dimming time reduction set (see also the section on dimming speeds). If a subordinate dimming procedure is active while the priority operation is released, and you have set the "Behaviour at the end of priority operation" to the "Follows subordinate functions" value, the lights will be dimmed down to the current dimming value with the dimming time reduction for higher priority functions in the current dimming time reduction set. The lights then continue to be dimmed at the dimming speed of the function which is currently active.

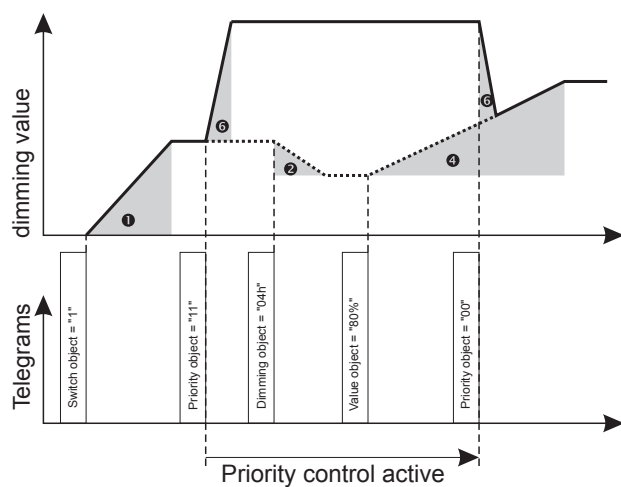

Parameter settings for the example in the image:

- Behaviour at start of priority operation "on" = "switch on to variable brightness"
- Required brightness at start of priority function in % = 100
- Behaviour at the end of priority function = "follows subordinate functions"

Image legend:

- ❶: Dimming time reduction for switching telegrams and switching on staircase lighting.
- ❷: Dimming time reduction for dimming telegrams.
- ❸: Dimming time reduction for value telegrams.
- ❹: Dimming time reduction for scene telegrams.
- ❺: Dimming time reduction for higher-level functions.

### Value of priority operation after bus voltage failure

The bus voltage may fail while priority operation is active. You can specify how priority operation should behave when the bus voltage recovers by setting a parameter:

Tab	Parameter
X: Priority operation	Behaviour of priority operation after bus voltage recovery

The settings have the following meaning:

- Inactive: After a bus voltage failure, priority operation will not be active. It must be activated by a new telegram if necessary.
- Active "off": After a bus voltage failure, priority operation will be directly active "off". Subordinate functions are not set, but are processed only in the background. In order to deactivate, the actuator must receive an appropriate telegram.
- Active "on": After a bus voltage failure, priority operation will be directly active "on". Subordinate functions are not set, but are processed only in the background. In order to deactivate, the actuator must receive an appropriate telegram.
- As before bus voltage failure: Priority operation is set to the status which was active before the bus voltage failure. If the function was active, it is now switched back to active again; if it was deactivated, it now remains switched off.



## Universal dimming 3211/1.0

### Disable function

If you have activated the disable function for a switching channel, a new communication object appears for this channel as a 1-bit object with the label "Disable object" and a new parameter window in which you can make the additional function settings.

#### Activating the disable function

Please first specify the starting behaviour of the disable function.

Tab	Parameter
X: Disable function	Block

You can use the "Lock" parameter to set the object value at which the function should be activated. If the "Disable object" receives a telegram with the object value "0" or "1" for activation, the disable function will be started. It will remain active until the "Disable object" receives a telegram with the opposite object value. You can use additional setting options to specify the behaviour of the dimming output at the start and the end of a disable function:

Tab	Parameter
X: Disable function	Behaviour at start of disable

Setting options:

- No response: The dimming output remains at its current value at the start of a disable function. This value can now no longer be changed as long as the disable function is active.
- Switch off: The dimming output is switched off and remains in this state until the end of the disable function, or until the disable function receives the first active switching or dimming telegram.
- Switch on with selectable brightness: The dimming output sets the brightness value which you have specified via a parameter:

Tab	Parameter
X: Disable function	Required brightness at start of disable function in %

#### Deactivating the disable function

The disabled dimming output remains in the selected status until the disable function is released again by a new telegram with the value "0" or "1". You can use parameters to set how a dimming output should respond when the disable function has been removed again:

Tab	Parameter
X: Disable function	Behaviour at the end of the disable function

Settings:

- No response: The disable function is deactivated without the dimming output responding. The output remains at its current brightness value until the next active switching or dimming telegram.
- Switch off: The dimming output is switched off at the end of the disable function.
- Switch on with selectable brightness: To allow you to set a variable brightness at the end of a disable function, an additional parameter appears:

Tab	Parameter
X: Disable function	Required brightness at end of disable function in %

- Follows secondary functions: Telegrams for the secondary functions continue to be processed in the background while a disable function is active, but are not forwarded to the dimming outputs. After the end of the disable function, the dimming output is set to the value which has been calculated in the background for the secondary functions.

#### Dimming speed of the disable function

The dimming speed for changes in brightness during activation, deactivation and during a disable function is determined by the setting for the current dimming time reduction set (see also the section on dimming speeds). If a subordinate dimming procedure is currently active at the end of a disable function, and you have set the "Behaviour at end of blocking" to the "Follows secondary functions" value, the lights will be dimmed down to the current dimming value with the dimming time reduction for higher priority functions in the dimming time reduction set. The lights will then continue to be dimmed at the dimming speed of the function which is currently active.

The dimming speed for changes in brightness during activation, deactivation and during a disable function is influenced by the dimming time reduction for higher-level functions in the current dimming time reduction set (see also the section on dimming speeds). If a subordinate dimming procedure is currently active when priority operation is enabled, and you have set the "Behaviour at the end of priority operation" to the "Follows secondary functions" value, the lights will be dimmed down to the current dimming value with the dimming time reduction for higher priority functions in the current dimming time reduction set. The lights will then continue to be dimmed at the corresponding dimming speed of the function which is currently active.

## Universal dimming 3211/1.0

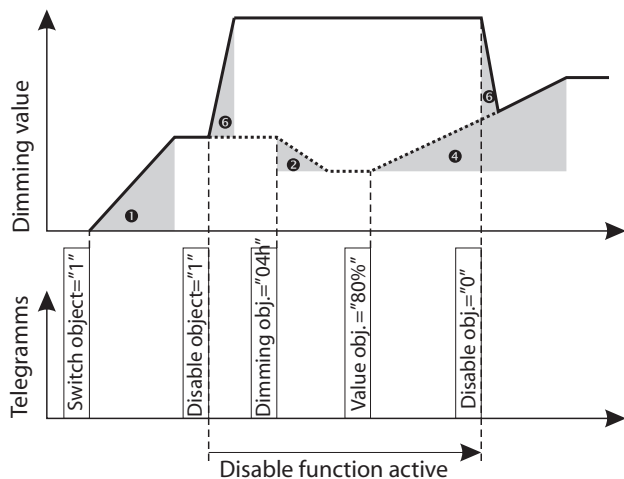

Parameter settings for the IMAGE:

- Disable = with object value "1"
- Behaviour at start of disable = "Switch on with selectable brightness"
- Required brightness at start of disable function in % = 100
- Behaviour at end of disable = "Follows secondary functions"

Image legend:

- ①: Dimming time reduction for switching telegrams and switching on staircase lighting.
- ②: Dimming time reduction for dimming telegrams.
- ④: Dimming time reduction for value telegrams.
- ⑤: Dimming time reduction for scene telegrams.
- ⑥: Dimming time reduction for higher-level functions.

### Value of disable function after bus voltage failure

The bus voltage may fail while the disable function is active. You can specify the status of the disable function when the bus voltage recovers by setting a parameter:

Tab	Parameter
X: Disable function	Status of disable function after bus voltage recovery

The settings have the following meaning:

- Inactive: After a bus voltage failure, the disable function is not active. It must be activated by a new telegram if required.
- Active: After a bus voltage failure, the disable function will be directly active. Secondary functions are not set, but are processed only in the background. In order to deactivate, the "Disable object" must receive an appropriate telegram.

- As before bus voltage failure: The disable function is set to the status which was active before the bus voltage failure. If the function was active, it will now be switched back to active again; if it was deactivated, it now remains switched off.

### Communication objects

You can select the following communication objects:

#### Per input:

Function	Object name	Type	Prio	Flags	Behaviour
Channel X Higher-level function	Logic object	2 bit	Low	WC	Transmit/receive
Channel X Higher-level function	Priority operation	2 bit	Low	WC	Transmit/receive
Channel X Disable function	Disable object	1 bit	Low	WC	Transmit/receive

### ● Status messages

The software application provides you with numerous options for reporting the current appliance status and the status of the dimming channels via communication objects. Depending on these status messages, you can trigger certain control processes in the system or enable and disable functions. In addition, status messages are also suitable for displaying current operating statuses by means of visualisation software.

The status messages of the output channels are made available through communication objects. You can set the transmission characteristics of these status objects to one of the following values using parameters:

-Deactivated:

The status object is not active.

-Active status feedback object:

When the status changes, the new status will be automatically transmitted.

- Passive status object:

The status object does not transmit its values.

However, the current status is available in each case, and can be read out by other bus devices.

## Universal dimming 3211/1.0

### Status of switch object (channel-specific)

The option of querying or reporting the current status of the channel using the status feedback object is provided for each output channel. You can activate the feedback object for each channel individually. When you activate the feedback object, you simultaneously specify its transmission characteristic:

Tab	Parameter
X: General	Status switch

After you have activated the status feedback for the switch object in a channel, a new communication object appears for this channel. Depending on the transmission characteristic which you have selected, the designation of this object alternates between the "Feedback switch" or "Status switch" values.

The value of the feedback object of a channel always corresponds to the current output status ON or OFF. When dimmed, the setting corresponds to ON. The status of the feedback object corresponds to the status display "On" of the channel (for further information, please refer to the section on "Manual operation and status displays"). If you have set the feedback object as the status feedback object, the current object value is transmitted to the bus with each status change from OFF to ON, or vice versa.



The value of the switch object may differ from the current channel value (e.g. with parameterised delay times). For this reason, use the status of the channel as the status feedback object.

### Status of value object/brightness value (channel-specific)

The option of querying or reporting the current brightness value of the channel using the communication object is also provided for each output channel. You can activate the feedback object for each channel individually. When you activate the feedback object, you simultaneously specify its transmission characteristic:

Tab	Parameter
X: General	Status of value object/ brightness value

After you have activated the status feedback for the brightness value of a channel, a new communication object appears for this channel. Depending on the transmission characteristic which you have selected, the designation of this object alternates between the "Feedback value object/brightness value" or "Status value object/brightness value" values.

The value of the feedback object of a channel always corresponds to the current dimming value of the output between 0% and 100% in 255 steps.

If you have set the feedback object as the status feedback object, the current object value will be transmitted to the bus **provided the output has reached a stable dimming value**. The object value is therefore transmitted when:

- A dimming procedure is completed
- The minimum or maximum dimming value has been reached
- A dimming procedure has been stopped by manual operation

The object value of the feedback object as a passive status object always corresponds to the current output value.

### Communication objects

You can select the following communication objects:

#### Per input:

Function	Object name	Type	Prio	Flags	Behaviour
Channel X Status AB	Feedback AB	1 bit / 1 byte/	Low	WCT	Transmit/ receive

# Universal dimming 3211/1.0

## ● Manual operation

### Manual operation

A channel switch for each output channel is located on the front side of the control unit. You can use this channel switch to manually operate the assigned output (channel switch operation). Only switching on or off is possible - manual dimming is not possible. Manual operation is always possible via the channel switches and therefore has the highest priority level irrespective of the software functions.

## ● Status displays

The green run LED shows the operating status.

### Operating status

The green run display lights up when the control unit is functioning correctly, the software application is running and the bus voltage is being applied.

### Physical address

When the bus voltage has been applied to the control unit, you can assign the physical address using the ETS software. Press the programming key to put the device into programming mode. This is indicated when the red programming LED lights up. Now you can load the physical address. When loading has successfully completed, the red programming LED goes out.

### Behaviour after download

Behaviour after downloading the application can be parameterised as follows:

#### Relay no change or as after bus voltage recovery

You can parameterise whether priority operation and the disable function will be active after a download. For the scene function, you can also specify whether or not the saved brightness values should be overwritten by your settings during a download (please refer to the section "Scene function").

Tab	Parameter
X: General	Behaviour after download (control voltage = 10 V)

### Behaviour on bus voltage recovery

You can set the behaviour of the device functions individually for each channel of the control unit following a bus voltage failure.

After bus voltage recovery, speed set "0" will be active. The dimming speed is oriented on the active function.

- Value of switch object after bus voltage failure

You can specify the behaviour of the switch object after a bus voltage failure using a parameter:

Tab	Parameter
X: General	Behaviour on bus voltage recovery

Settings:

-Relay no change: The output channel will dim up to maximum brightness if the relay was previously switched on.

-Relay switch off: The output is switched off.

-switch on to initial brightness, see the "Starting behaviour" parameters on the channel:X tab.

The output is switched on at the set initial brightness.

### Behaviour on bus voltage failure

You can set the behaviour of the device functions individually for each channel of the control unit following a bus voltage failure.

Tab	Parameter
X: General	Behaviour on bus voltage failure (control voltage = 10 V)

Settings:

-Relay no change: The output channel will dim up to maximum brightness if the relay was previously switched on.

-Relay switch off: The output is switched off.

-Relay switch on: The output channel dims up to maximum brightness.

## Universal dimming 3211/1.0

If other advanced or higher priority functions are active on bus voltage recovery, your settings for the reaction of the switch object can be overwritten.

- Value of the logic object after bus voltage recovery

Tab	Parameter
X: Logic operation	Value of the logic object after bus voltage recovery and downloading

If you have activated the logic function, the set value for each output channel will be activated after downloading or after the bus voltage has returned at the input of the logic functions.

- Value of priority operation after bus voltage recovery

You can specify how priority operation should behave when the bus voltage recovers by setting a parameter:

Tab	Parameter
X: Priority operation	Behaviour of priority operation after bus voltage recovery

The settings have the following meaning:

- Inactive: After a bus voltage failure, priority operation will not be active. It must be activated by a new telegram if necessary.

- Active "off": After a bus voltage failure, priority operation will be directly active with the behaviour at the start of priority operation "off". Secondary functions are not set, but are processed only in the background. In order to deactivate, the actuator must receive an appropriate telegram.

- Active "on": After a bus voltage failure, priority operation will be directly active with the behaviour at the start of priority operation "on". Secondary functions are not set, but are processed only in the background. In order to deactivate, the actuator must receive an appropriate telegram.

- As before bus voltage failure: Priority operation will be set to the status which was active before the bus voltage failure. If the function was active, it will now be switched back to active again; if it was deactivated, it now remains switched off.

- Value of disable function after bus voltage failure

You can specify the status of the disable function when the bus voltage recovers by setting a parameter:

Tab	Parameter
X: Disable function	Status of disable function after bus voltage recovery

The settings have the following meaning:

- Inactive: After a bus voltage failure, the disable function is not active. It must be activated by a new telegram if necessary.

- Active: After a bus voltage failure, the disable function will be directly active. Secondary functions are not set, but are processed only in the background. In order to deactivate, the "Disable object" must receive an appropriate telegram.

- As before bus voltage failure: The disable function is set to the status which was active before the bus voltage failure. If the function was active, it will now be switched back to active again; if it was deactivated, it now remains switched off.

## Universal dimming 3211/1.0

### Parameters and settings

This section contains all of the parameters of the ETS application together with their settings. Preset values are printed in bold.

General	
Parameter	Setting
Channel X	Deactivated
	<b>Activated</b>
Scenes	<b>Disabled</b>
	Enabled
Extension unit scenes	Disabled
	<b>Enabled</b>
Central function	<b>Disabled</b>
	Enabled
Central switch object	Deactivated
	<b>Activated</b>
Central dimming object	Deactivated
	<b>Activated</b>
Central value object	Deactivated
	<b>Activated</b>
Same dimming time at central function and scenes	<b>Disabled</b>
	Enabled

Same dimming time	
Parameter	Setting
Time base for same dimming time	<b>1 s</b> , 1 min, 1 hour
Time factor for same dimming time 1 - 255	<b>1.5</b> ..255
Time factor for same dimming time selectable via bus	Deactivated
	<b>Activated</b>

X: General	
Parameter	Setting
Minimum dimming value in %	<b>1..10</b> ..100
Maximum dimming value in %	1... <b>100</b>
Initial brightness	<b>Max. brightness</b>
	Selectable brightness
	Last brightness value (memory)
Basic dimming curve	<b>Fluorescent lamps</b>
	Halogen lamps
	Can be altered
Dimming object switches channel	Not
	<b>Only ON, not OFF</b>
	Only OFF, not ON
	ON and OFF
Value object switches channel	Not
	Only ON, not OFF
	Only OFF, not ON
	<b>ON and OFF</b>
Delay times	<b>Disabled</b>
	Enabled
Staircase lighting function	<b>Deactivated</b>
	Activated
Switch object influences logic operation	<b>Unchanged</b>
	Inverted
Scenes	<b>Disabled</b>

	Enabled
Central function	<b>Disabled</b>
	Enabled
Higher priority function	<b>Deactivated</b>
	Logic operation
	Priority operation
Disable function	<b>Deactivated</b>
	Activated
Behaviour when bus voltage fails (control voltage = 10 V)	Relay switch off
	Relay switch on
	<b>Relay no change</b>
Behaviour on bus voltage recovery	<b>Relay no change</b>
	Relay switch off
	Switch on at initial brightness
Behaviour after download (control voltage = 10 V)	Relay no change
	<b>As for bus voltage recovery</b>
Status switch	<b>Deactivated</b>
	Activated
Status of value object/brightness value	<b>Deactivated</b>
	Activated

X: Basic dimming curve	
Parameter	Setting
1st threshold value in %	0.. <b>25</b> ..100
2nd threshold value in %	0.. <b>50</b> ..100
3rd threshold value in %	0.. <b>75</b> ..100
Time base for 1st dimming section	<b>100 ms</b> , 1 s, 1 min, 1 hour
Time factor for 1st dimming section (1 - 255)	1.. <b>200</b> ..255
Time base for 2nd dimming section	<b>100 ms</b> , 1 s, 1 min, 1 hour
Time factor for 2nd dimming section (1 - 255)	1.. <b>180</b> ..255
Time base for 3rd dimming section	<b>100 ms</b> , 1 s, 1 min, 1 hour
Time factor for 3rd dimming section (1 - 255)	1.. <b>120</b> ..255
Time base for 4th dimming section	<b>100 ms</b> , 1 s, 1 min, 1 hour
Time factor for 4th dimming section (1 - 255)	1.. <b>50</b> ..255

X: Dimming time reductions	
Parameter	Setting
Dimming time reduction object for dimming curve	<b>Deactivated</b>
	Activated
Format of dimming time reduction	<b>1 - 100%</b>
	1 - 255 (corresponds to 1 - 100%)
Set 0: dimming time reduction for switching telegrams and staircase light, switch on at	1.. <b>2%</b> ..100
Set 0: dimming time reduction for dimming telegrams at	1.. <b>6%</b> ..100
Set 0: dimming time reduction for switch off staircase light at	1.. <b>50%</b> ..100
Set 0: dimming time reduction for value telegrams at	1.. <b>15%</b> ..100

## Universal dimming 3211/1.0

Set 0: dimming time reduction for scene telegrams at	1..20%..100
Set 0: dimming time reduction for higher priority functions at	1..2%..100
Sets 1 to 3	<b>Disabled</b> Enabled
Set 1: dimming time reduction for switching telegrams and staircase light, switch on at	1..6%..100
Set 1: dimming time reduction for dimming telegrams at	1..20%..100
Set 1: dimming time reduction for switch off staircase light at	1..70%..100
Set 1: dimming time reduction for value telegrams at	1..30%..100
Set 1: dimming time reduction for scene telegrams at	1..70%..100
Set 1: dimming time reduction for higher-level functions	1..5%..100
Set 2: dimming time reduction for switching telegrams and staircase light, switch off at	1..3%..100
Set 2: dimming time reduction for dimming telegrams at	1..15%..100
Set 2: dimming time reduction for switch off staircase light at	1..40%..100
Set 2: dimming time reduction for value telegrams at	1..15%..100
Set 2: dimming time reduction for scene telegrams at	1..25%..100
Set 2: dimming time reduction for higher priority functions at	1..3%..100
Set 3: dimming time reduction for switching telegrams and staircase light, switch on at	1%..100
Set 3: dimming time reduction for dimming telegrams at	1..7%..100
Set 3: dimming time reduction for switch off staircase light at	1..25%..100
Set 3: dimming time reduction for value telegrams at	1..10%..100
Set 3: dimming time reduction for scene telegrams at	1..20%..100
Set 3: dimming time reduction for higher priority functions at	1%..100

Delay times	
Parameter	Setting
ON delay	<b>Deactivated</b>
	Retriggerable
	Not retriggerable
Output during the ON delay	Switched off
	<b>At minimum brightness/ lower dimming limit</b>
Time base for ON delay	100 ms
	1 s
	<b>1 min</b>
	1 hour
Time factor for ON delay (1 - 255)	1..3..255
OFF delay	<b>Deactivated</b>
	Retriggerable
	Not retriggerable
Time base for OFF delay	100 ms
	1 s
	<b>1 min</b>

	1 hour
Time factor for OFF delay (1 - 255)	1..3..255

X: Staircase timer	
Parameter	Setting
Staircase lighting function	<b>Not retriggerable with manual OFF</b>
	Retriggerable with manual OFF
	Sum up time with manual OFF
	Not retriggerable without manual OFF
	Retriggerable without manual OFF
Sum up time without manual OFF	
Max. number of time accumulations (2 - 255)	2..3..255
Time base, staircase timer	1 s
	<b>1 min</b>
	1 hour
Time factor for staircase timer (1 - 255)	1..3..255
Staircase timer influences logic operation	<b>Unchanged</b>
	Inverted
Disconnection warning for staircase timer	Deactivated
	<b>Activated</b>
Warning time for staircase timer in seconds (1 - 255)	1..30..255

X: Scenes	
Parameter	Setting
Override scene values in actuator during download	Deactivated
	<b>Activated</b>
Same dimming time	<b>Deactivated</b>
	Activated
Scene 1	<b>Deactivated</b>
	Activated
Scene 1: Scene number (0 - 63)	0..63
Scene 1: Brightness value in %	0..15..100
Scene 2	<b>Deactivated</b>
	Activated
Scene 2: Scene number (0 - 63)	0..1..63
Scene 2: Brightness value in %	0..35..100
Scene 3	<b>Deactivated</b>
	Activated
Scene 3: Scene number (0 - 63)	0..2..63
Scene 3: Brightness value in %	0..50..100
Scene 4	<b>Deactivated</b>
	Activated
Scene 4: Scene number (0 - 63)	0..3..63
Scene 4: Brightness value in %	0..65..100
Scene 5	<b>Deactivated</b>
	Activated
Scene 5: Scene number (0 - 63)	0..4..63
Scene 5: Brightness value in %	0..80..100
Scene 6	<b>Deactivated</b>
	Activated
Scene 6: Scene number (0 - 63)	0..5..63
Scene 6: Brightness value in %	0..80..100
Scene 7	<b>Deactivated</b>

# Universal dimming 3211/1.0

	Activated
Scene 7: Scene number (0 - 63)	0.. <b>6</b> ..63
Scene 7: Brightness value in %	0.. <b>80</b> ..100
Scene 8	<b>Deactivated</b>
	Activated
Scene 8: Scene number (0 - 63)	0.. <b>7</b> ..63
Scene 8: Brightness value in %	0.. <b>80</b> ..100

X: Central function	
Parameter	Setting
Same dimming time	<b>Deactivated</b> Activated
Function with the central switch object = 0	No response <b>Switch off</b> Switch on with selectable brightness
Function at central switching value = 1	No response Switch off <b>Switch on with selectable brightness</b>
Required brightness at central switching object = 0 in %	5.. <b>100</b>
Required brightness with central switch object = 1 in %	5.. <b>100</b>

X: Logic operation	
Parameter	Setting
Logic operation	AND <b>OR</b>
Logic object effective	<b>Unchanged</b> Inverted
Value of logic operation object after bus voltage recovery and download	<b>0</b> 1
Brightness with logic object "0" in % (with AND logic operation)	0.. <b>100</b>
Brightness with logic object "1" in % (with OR logic operation)	0.. <b>100</b>

X: Priority operation	
Parameter	Setting
Behaviour on start of priority operation "on"	No response Switch off <b>Switch on with selectable brightness</b>
Required brightness at start of priority operation "on" in %	5.. <b>100</b>
Behaviour at start of priority function "off"	No response <b>Switch off</b> Switch on with selectable brightness
Required brightness at start of priority function "off" in %	5.. <b>100</b>
Behaviour at the end of priority operation	No response Switch off Switch on with selectable brightness <b>Follows secondary functions</b>
Required brightness at end of priority function in %	5.. <b>100</b>

Behaviour of priority function after bus voltage recovery	Inactive
	Active "off"
	Active "on"
	<b>As before bus voltage failure</b>

X: Disable function	
Parameter	Setting
Disable	At object value "0" <b>At object value "1"</b>
Behaviour at start of disable	No response Switch off <b>Switch on with selectable brightness</b>
Required brightness at start of disable function in %	5.. <b>100</b>
Behaviour at end of disable	No response <b>Switch off</b> Switch on with selectable brightness Follows secondary functions
Required brightness at end of disable function in %	5.. <b>100</b>
Status of disable function after bus voltage recovery	Inactive Active <b>As before bus voltage failure</b>