

KNX ARGUS Presence with light control and IR receiver

Operating instructions

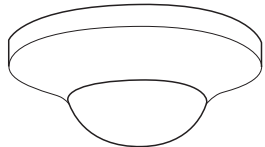

Art. no. MTN6309..

Accessories

- Surface-mounted housing for ARGUS Presence (Art. no. MTN550619)

For your safety



DANGER

Risk of fatal injury from electrical current.

All work carried out on the unit may only be performed by skilled electricians. Observe the regulations valid in the country of use, as well as the valid KNX guidelines.

ARGUS introduction

The KNX ARGUS Presence with light control and IR receiver (called **ARGUS** in the following) is a KNX presence detector for interior ceiling mounting. It detects smaller movements within a circumference of 360° and a radius of 7 m (at a mounting height of 2.5 m).



The specified ranges refer to average conditions for the recommended mounting height and are therefore guide values. The range and sensitivity can vary greatly when the temperature fluctuates.

When movement is detected, a data telegram defined by the programming is transmitted and then evaluated to control the lighting, blinds, or heating, for example.

The ARGUS presence function continuously adjusts for brightness in the room. If sufficient natural light is available, the device will switch the artificial light off even if a person is present. The overshoot time can be adjusted using the ETS. The integrated light sensor continually measures the brightness level and processes this information in the application. In addition, it is possible to measure the brightness with an external light sensor and have it evaluated.

Light control enables the required brightness set in the ETS to be achieved permanently. Dimming and the optional use of a second lighting group maintains a constant brightness.

The functions of the IR receiver are specified by the application. The following functions can be carried out with a suitable IR remote control (e.g. Art. no. MTN570222).

- Change individual configurations of the ARGUS.
- Remote control of other KNX devices.



The IR receiver of the ARGUS can manage up to 50 channels. Suitable assignment is made in the ETS.

The ARGUS also has four movement sensors. You can set their sensitivity and range sector-specifically in the ETS.

The device is designed for use in offices, schools, public buildings or at home, for example. It is intended for ceiling mounting in a No. 60 mounting box, and can also be mounted on the ceiling in the surface-mounted housing for ARGUS Presence. The ARGUS has an integrated bus coupler and its power is supplied via KNX.

Using ARGUS with alarm systems



Movement/presence detectors are not suitable for use as components of an alarm system.



Movement/presence detectors can trigger false alarms if the installation site has been chosen unfavourably.

Movement/presence detectors switch on as soon as they detect a moving heat source. This can be a person, but also animals, trees, cars or differences in temperature in windows. In order to avoid false alarms, the chosen installation site should be such that undesired heat sources cannot be detected (see section „Selecting the installation site“).

Connections, displays and operating elements

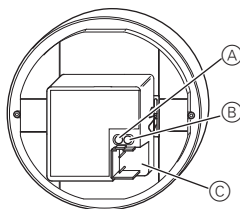

- (A) Programming button
- (B) Programming LED
- (C) Bus connecting terminal

Alignment of the movement sensors (A, B, C, D)

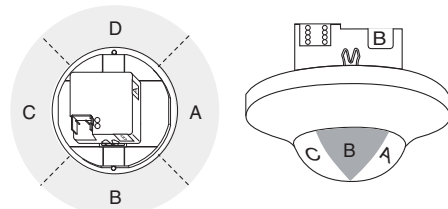

Selecting the installation site

When selecting a suitable installation site, you should take a number of factors into account so that the ARGUS operates optimally.

- The shorter the distance between the detected person and the ARGUS, the better smaller movements are detected.
- When a person is walking, a larger area of detection is available. The reference level for the detection is the floor.
- The mounting height has a direct effect on the range and sensitivity of the ARGUS. The optimal mounting height is 2.5 m.

The following diagram shows the ranges of the ARGUS. They are based on average temperature conditions at a mounting height of 2.5 m. The range of a movement detector can fluctuate considerably at variable temperatures.

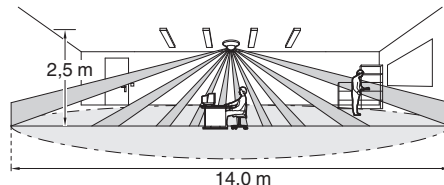

Mounting height	Area of detection
2.0 m	11 m
2.5 m	14 m
3.0 m	17 m

- The position of the ARGUS in regard to the direction of movement also affects detection. If possible, install the movement detector sideways to the direction of movement.

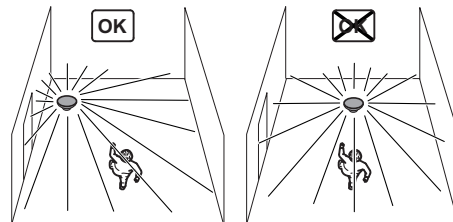

- If you wish to attach several presence detectors, install them so that the detection areas of the individual devices intersect each other.
- The ARGUS is designed for permanent installation only. Mount the ARGUS on a fixed base only to avoid faulty operation caused by the movement of the detector.
- To prevent undesired load switching, do not mount the switched luminaire directly in the detection area of the ARGUS.
- Avoid mounting the device above a luminaire (e.g. standard lamp). The heat radiation of the luminaire can influence the function of the ARGUS. Brightness can no longer be measured when there is direct light incidence. If luminaires are mounted in the ARGUS detection area, a distance of at least 3 m must be complied with when the connection load is high.

ARGUS installation

i The retaining ring and thus the movement sensors themselves can only be rotated in 90° increments. To optimally adjust the movement sensors to the movement in the space, you have to align the installation boxes or the surface-mounted housing appropriately when mounting.

- 1 The ARGUS is connected via a bus connecting terminal and snapped onto the retaining ring.

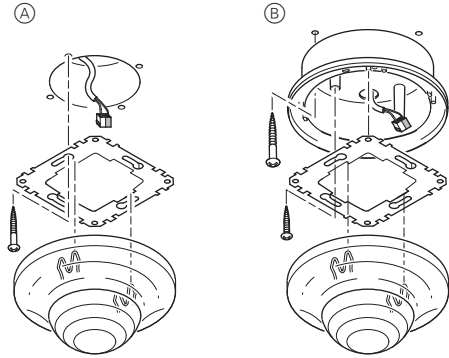

- (A) Flush-mounted installation
(B) Surface-mounted installation

For flush-mounted installation, the retaining ring included with supply is fixed with two screws to a size 60 installation box. For surface mounting, the retaining ring is mounted in the surface-mounted housing which is available as an accessory.

Putting ARGUS into operation

- 1 Press the programming button.
The programming LED lights up.
- 2 Load the physical address and application into the device from the ETS.
The programming LED goes out.
The application has been loaded successfully, the device is ready for operation.

Setting ARGUS

Setting the movement sensors

The ARGUS has four movement sensors (A, B, C, D). You can set their sensitivity and range sector-specifically in the ETS.

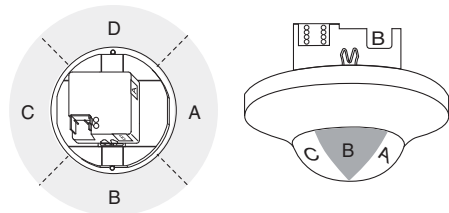

Technical data

Nominal voltage:	DC 24 V (+6 V / -4 V)
KNX connection:	Bus connecting terminal
Current consumption:	max. 8 mA
Angle of detection:	360°
Number of levels:	6
Number of zones:	136 with 544 switching segments
Number of movement sensors:	4, separately adjustable
Recommended mounting height:	2 m - 5 m, optimum 2.50 m
Light sensor:	infinitely adjustable in ETS between approx. 10 and 2000 lux In general, the values measured by the sensor deviate from the lighting conditions at the main place of usage (e.g. work surface). The extent of the deviation is dependent on the installation site of the sensor, the properties of the room (reflection of the luminaires, type of paint on the walls and the surfaces) and the luminaires used.
Range:	Radius of approx. 7 m; can be set in ETS
Overshoot time:	from 1 s to 255 hours; can be set in the ETS
Display elements:	1 red programming LED
Operating elements:	1 programming button
Number of IR channels:	10 for controlling other KNX devices, 10 for configuration (channel numbers 1 - 50)
IR operator panels:	e.g. IR remote control Art. no. MTN570222
Ambient temperature	
Operation:	-5 °C to +45 °C (at temperatures > 30 °C, movement detection is limited)
Storage:	-25 °C to +45 °C
Transport:	-25 °C to +70 °C
EC guidelines:	EMC guideline 89/336/EEC
Initialisation:	Due to the limitation of the telegram rate, a telegram cannot be generated until 20 seconds after initialisation at the earliest.
Type of protection:	IP 20

i When using the IR function, a separation of the IR channels must be noted. When installing several devices in one area, either a different channel should be parameterised for each device or there is only one central device for processing IR commands.

Schneider Electric Industries SAS

If you have technical questions, please contact the Customer Care Center in your country.

www.schneider-electric.com

This product must be installed, connected and used in compliance with prevailing standards and/or installation regulations. As standards, specifications and designs develop from time to time, always ask for confirmation of the information given in this publication.

Presence / monitoring / light control / IR - 1335/1.0

● **General**

Application 1335/1.0 has been developed for the KNX presence detector with light control and IR receiver, MTN6309xx. In the following the device will be referred to as the presence detector.

The task of the light control is to facilitate presence-dependent light control by means of a brightness sensor. The light control can be switched on either automatically by means of a movement sensor or manually by a local push-button.

The distinctive feature of the presence detector function is the integrated sensor, which measures brightness continuously. This function is able to measure and evaluate changes in the external brightness (daylight) even when artificial lighting is switched on. Even when people are present, the presence detector function switches off the lighting when the external brightness is sufficient (above the brightness threshold set) for working and safe use of the rooms without additional artificial lighting. This feature reduces energy consumption. The presence detector will not switch the lighting on until it detects movement in front of the device when the ambient brightness is too low. If movement is no longer detected in the activated state, the integrated staircase timer will switch the lighting back off.

In contrast to this, the movement block will only switch off when there is no more movement in front of the device - in other words, independently of the brightness. The switch-on condition is however the same as with the presence detector block.

The ETS application includes 5 independent presence or movement blocks, each with 4 output objects and 1 light control block. 10 IR function blocks and 10 IR configuration blocks are available for changing internal device parameters.

The technical data for the presence detector may be found in the description of the device.



Note:

All of the settings described refer to ETS version 3, but you can also use all the settings and functions with ETS version 2.

The application files (vd2 and vd3) are configured in such a way that the application loading time is considerably reduced. When you convert an ETS 2 project to ETS 3, you lose this time saving. If you are working with ETS 3, use the vd3 files.

Total possible addresses and connections:
254 addresses; 255 connections



Note:

If you switch back to the preset values in either ETS 2 or ETS 3 (by clicking "Standard"), all the values that you have changed so far will be deleted. Any group addresses which have been parametrised will be lost.



Note:

Due to the fact that various functions depend on other functions, these dependent functions will not be visible and selectable in the ETS unless the preceding function has been enabled. If you de-select functions or change parameters, group addresses that have already been connected may be removed.

● **Getting started quickly**

When you insert the application in the ETS or click on the "Standard" button, the ETS application will switch automatically to minimum configuration.

In minimum configuration, it is possible to put the presence detector into operation. For some application cases, the minimum configuration is even adequate for practical use. We also recommend opening minimum configuration as a way of familiarising yourself with the application software for the presence detector. Here all of the extended or more complex parameters are disabled. In "Block configuration" only the first "Movement/presence" block is enabled for use. In this configuration, light control and IR receiver functions have not yet been enabled. In the "Telegrams" tab only output object 1 is enabled. This is a 1-bit output object. At the start of movement this object sends a 1 telegram and when the internal staircase timer has elapsed it sends a 0 telegram. Each parameter can always be tuned to its individual requirements. The brightness threshold and the staircase timer always need to be adjusted to suit requirements. Check the "Brightness" and "Times" tabs.

In this way the corresponding objects are connected to a KNX switch actuator.

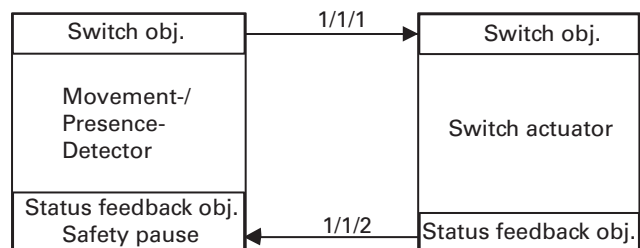

To familiarise yourself with the extended and more complex parameters see the following pages.

● **General functions**

The common safety pause

When lights installed in the area of detection of the presence detector are switched, optical feedback can occur. The temperature difference between the luminaires or the change in the infrared spectrum can be interpreted as a movement by passive infrared movement or presence detectors (optical feedback).

The application has a common safety pause system - in other words, a safety pause triggered by the presence detector will affect all blocks in the application (except for IR receiver functions). As specified in a parameter the safety pause can be triggered at the status feedback object (safety pause) when there is an OFF telegram or when there is an OFF and ON telegram.

The status feedback object of the switching/dimming actuator must be connected to the feedback safety pause object of the presence detector.

Once a safety pause has been started, signals from the movement sensor will no longer be evaluated for this period of time. An elapsed staircase timer cannot be started by a movement during an active safety pause and an ongoing staircase timer cannot be retriggered by a movement.

An ongoing staircase timer is not affected by a safety pause being activated. In other words, the staircase timer will run through in the usual way.



Note:

Optical feedback can only be avoided by selecting the right installation location for the presence detector and the lighting. The safety pause system and the safety pause object of the application cannot compensate for all planning mistakes.

Communication objects

You can select the following communication objects:

General:

Function	Object name	Type	Prio	Flags	Behaviour
Safety pause	Status feedback object	1 bit	Low	WC	Receive

Parameter



Note:

The parameter settings include various functions which depend on other functions. Depending on the parameter setting, some functions or objects may or may not be displayed in the ETS.

General	
Parameter	Setting
Safety pause via status feedback object	Disabled
	For OFF telegram
	For ON and OFF telegram
Safety pause (1 - 20) seconds	1-20, preset: 2

● **General brightness evaluation:**

The current brightness can be determined by the internal brightness sensor, by an external communication object or by both dependencies. The relationship between internal and external values can be parametrised while doing this.

Communication objects

You can select the following communication objects:

General:

Function	Object name	Type	Prio	Flags	Behaviour
External sensor	Actual value input	2 bytes	Low	WCT U	Transmit/ receive/ update

Parameter

General	
Parameter	Setting
Actual value (brightness)	From internal sensor
	From object, actual value input
	From internal sensor and object
Taking the separately measured lux value (0% - 100%) into account	0% - 100%, in 5% steps; preconfiguration 50%

Actual value correction

The measured brightness value (actual value) can be corrected. A distinction is drawn here between the installation location of the presence detector and the reference area (a desk surface, for example). The brightness value of the reference area is determined with the aid of actual value correction and taking the brightness value measured by the presence detector at the installation location and an internal adjustment curve into account. In the case of light control it is not the brightness value at the installation location which is important but the brightness value at the reference area (desk).

For actual value correction you will need a luxmeter. The measured values are then input into the application software of the presence detector. When intense sunlight is shining onto the reference area or the installation location, the measurements should not be taken. Under certain circumstances darkening the room may improve the measurement results.

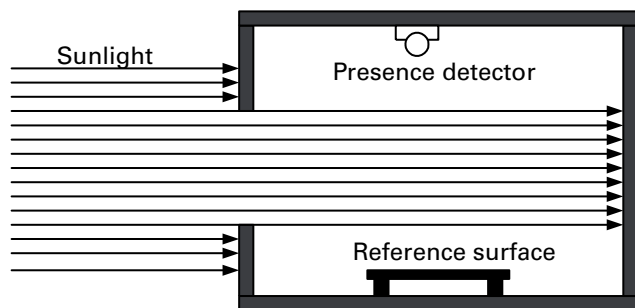

Optimal light conditions for actual value correction. Measurement results at the installation location or at the reference area are affected equally by natural light.

Four measurements are required for actual value correction:

- Artificial lighting is switched off, brightness is measured at the presence detector installation location.
- Artificial lighting is switched on (maximum brightness), brightness is measured at the presence detector installation location.
- Artificial lighting is switched off, brightness is measured at the reference area (desk, for example).
- Artificial lighting is switched on (maximum brightness), brightness is measured at the reference area (desk, for example).

The four lux values measured are entered in the application software. When "Actual value correction" is enabled, four fields are available on the "General" tab. "Light switched off" or "Light max. brightness" for the actual value at the installation location. The same applies to the actual value at the reference area.

The brightness value determined applies to all presence/movement blocks and the lighting controller. This value can be transmitted cyclically to the bus.

i Note: Should the situation in the room change due to different furniture, floor coverings or ceiling, for example - in other words, when reflective surfaces in the room change - take a new measurement. The measured values are entered into the application software. The presence detector will then need to be reprogrammed.

Communication objects

You can select the following communication objects:

General:

Function	Object name	Type	Prio	Flags	Behaviour
Transmit	Resulting actual value	2 bytes	Low	CT	Transmit
Brightness value, dimming actuator	Status feedback	1 byte	Low	WCT U	Transmit/receive/update

Parameter

i Note: The parameter settings include various functions which depend on other functions. Depending on the parameter setting, some functions or objects may or may not be displayed in the ETS.

General	
Parameter	Setting
Actual value correction.	Enabled Disabled
Actual value (0 - 2000 lux) installation location	
Lamp switched off	0 - 2000; preconfiguration 50
Max. brightness of lamp	0 - 2000; preconfiguration 100
Actual value (0 - 2000 lux) reference area	
Lamp switched off	0 - 2000; preconfiguration 100
Max. brightness of lamp	0 - 2000; preconfiguration 350
Transmit actual value cyclically, reference area (or from installation location)	Enabled Disabled
Time base, transmit lux value	1 s 1 min 1 hr
Time factor, send lux value (1 - 255)	1-255; preconfiguration 30

● Presence / movement block

Basic function of a presence block

A staircase timer is "integrated" into a presence block. When the ambient brightness is too low **and** a movement is detected, the presence block sends an ON telegram on the bus. When movement is no longer detected, the staircase timer starts. An OFF telegram is transmitted to the bus after a parametrised time.

Should the brightness rise beyond a specific threshold, a parametrised time period will be started and when it has elapsed an OFF telegram will also be transmitted.

Basic function of a movement block

A staircase timer is "integrated" into a movement block as is the case with a presence block. When the ambient brightness is too low **and** a movement is detected, the movement block transmits an ON telegram to the bus. When no further movement is detected the staircase timer starts. An OFF telegram is transmitted to the bus after a parametrised time.

In contrast to the presence block, brightness is measured **only** at the moment when the first movement is detected. If further movement is detected, an OFF telegram is **not** transmitted, irrespective of brightness changes. The staircase timer starts only when movement is no longer detected, and an OFF telegram is transmitted after the parametrised time period.

Block configuration

Up to five movement/presence blocks are available. In the default setting, block 1 is enabled.

Parameter

Block configuration	
Parameter	Setting
Movement/presence block X	Enabled
	Disabled

Movement detection

The device has a detection angle of 360°. The 360° detection angle is divided into four sectors. The sectors are each 90° and are designated by the letters A, B, C and D.

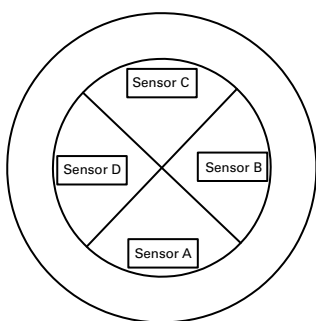

Four independent passive infrared sensors (sectors A to D) input into movement detection. Via the ETS it is possible to parametrise all four sensors at the same time or each sector can be parametrised individually. In the "Movement sensors" tab, the settings "Enabled" or "Disabled" can be made. When the sector-orientated settings are disabled, sensitivity and range for all four sensors will be changed to the same degree. When the sector-orientated settings are "Enabled," further tabs where sectors A to D can be parametrised individually appear. "Object range" and "Dead time, movement start" each relate to all four sensors of the block in question. For each movement sensor the range and sensitivity for each block can be set independently via parameters or using an IR remote control. Note: Only the range can be set with an IR remote control, not the sensitivity. Another option is setting the range via the Range communication object which can be enabled for each block. To suppress disturbance variables or if delayed activation is required, a dead time for the start of movement can be activated. The dead time is started after movement has been detected (start of movement). The start of movement action (transmitting a telegram to the bus) can take place if a movement is still detected within the movement time after the dead time has elapsed.

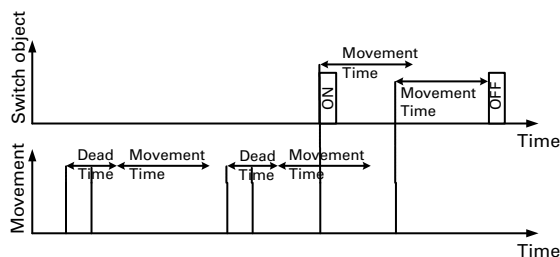

In master mode or normal mode the movement time corresponds to the staircase timer in the diagram above. In slave mode or monitoring mode the movement time corresponds to the cycle time. In practice a large number of applications can be implemented by means of the various blocks and sensors.

An example of practical application:

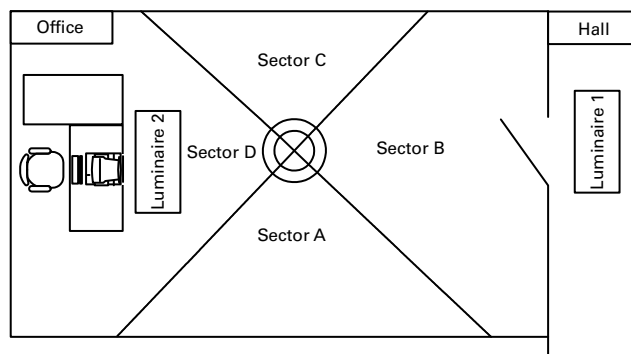

- Luminaire 1 should only switch on when there is a movement in the hall.
- For presence block 1 sectors A, C and D are disabled, sector B is enabled and switches luminaire 1.
- Luminaire 2 should only switch on when there are movements near the desk.
- For presence block 2 sectors A, C and D are enabled and switch luminaire 2; sector B is disabled.

Block diagram of presence/movement block

A block diagram clarifies the relationships between the individual dependencies.

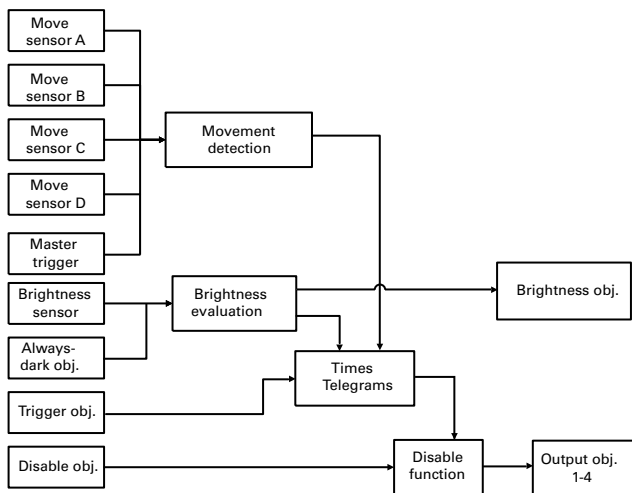

Movement evaluation

As has already been stated above, the four movement sensors input into movement detection. The master trigger object is brightness-dependent and with an ON telegram simulates a movement; an OFF telegram is ignored. The trigger object is brightness-independent and also simulates a movement for an ON telegram. Whether the trigger object can switch the lighting off early when there is an OFF telegram can be parametrised.

Note: The master trigger object and the trigger object do not appear in the ETS until the device operating mode has been set to "Master mode". See "Block X, general" tab, parameter: "Operating mode". The master/trigger object ignores the dead time (for Dead time, see above) and reacts without a delay. More detailed information about the master/trigger object may be found later on.

Communication objects

You can select the following communication objects:

Block X, general movement sensors:

Function	Object name	Type	Prio	Flags	Behaviour
Block X	Range	1 byte	Low	WC	Receive

Parameter

Note: The parameter settings include various functions which depend on other functions. Depending on the parameter setting, some functions or objects may or may not be displayed in the ETS.

Block X, general - movement sensors

Parameter	Setting
Sector-orientated settings	Enabled
	Disabled
The following settings are only visible when "Sector-orientated settings" is "Disabled".	
Sensitivity (for all sensors)	High
	Medium
	Low
Range (for all sensors)	10% - 100% (in 10% steps) preconfiguration: 100%
The following settings are only visible when "Sector-orientated settings" is "Enabled".	
Range object (for all sensors)	Disabled
	Enabled
Dead time, start of movement (for all sensors)	Disabled
	Enabled
Time base	1 min , 1s
Time factor (1 - 255)	3 , (1-255)
Sector X	Enabled
	Disabled

Block X, general movement sensors sector X	
Parameter	Setting
Sensitivity	High
	Medium
	Low
Range adjustable	Via parameters Via IR configuration
Overwrite range during download	Enabled Disabled
Range	10% - 100% (in 10% steps) preconfiguration: 100%
Change range via object	Disabled Enabled

● Brightness evaluation

Brightness evaluation of a presence detector

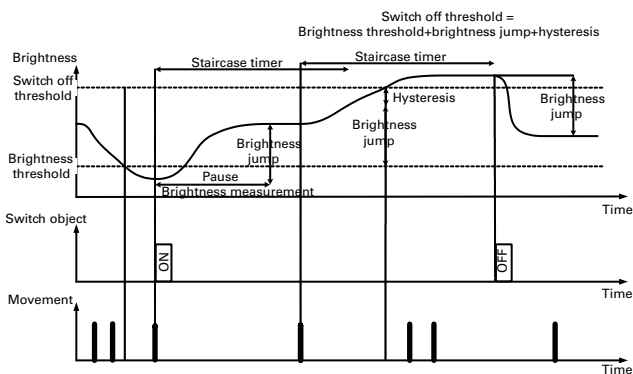

Once a movement has been detected below the set brightness threshold and the action carried out at the start of movement (here: transmitting an ON telegram), the brightness lock no longer has an effect. This means that a new movement can retrigger the staircase time. However, should the ambient brightness increase during this time to exceed the set brightness threshold + measured brightness jump + a hysteresis (with regard to the brightness threshold), an ongoing staircase timer period will not be retriggered. At the end of the staircase timer period an OFF telegram can be transmitted, depending on the parametrisation. A further option when the OFF threshold is exceeded is not to allow the remaining staircase timer period to elapse but instead to start a defined remaining running time.

Brightness evaluation of a movement detector:

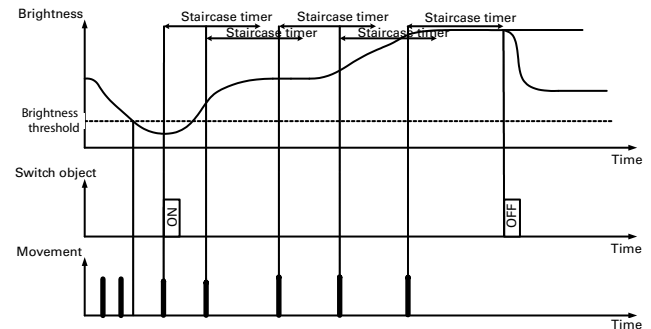

Where this differs from the presence detector is that the movement detector changes to non-brightness-dependent mode once the start of movement action (sending an ON telegram) has been carried out. Here freshly detected movements can retrigger the staircase timer. Unlike the presence detector, the movement detector cannot process the brightness jump and there is not even any setting of a hysteresis.

Brightness

The brightness threshold can be parametrised separately for each of the five movement/presence blocks. Each block has its own "Brightness" tab. A staircase timer be started (depending on parametrisation of the device) and an ON telegram transmitted to the bus only after the value is below the parametrised brightness threshold and the presence detector detects a movement. The brightness threshold can be set between 10 and 2000 lux.

Via the "Brightness" tab and the "Reaction with adequate brightness despite movement" parameter you can specify whether the selected block functions as a presence detector or a movement detector. If you select "Presence detector" in the ETS, the hysteresis will also need to be specified as a percentage and the pause for brightness measurement set. This setting is disabled if "Movement detector" has been selected.

Via the "Brightness threshold object" "Enabled" or "Disabled" you can select whether the brightness threshold should be changed via the bus. This can be useful when several presence detectors are installed in a building. The brightness threshold can be changed using the "Brightness threshold - Block X" object via the ETS or an IP touch panel, for example. The brightness threshold is set to the same level in all parts of the building.

Brightness object 1 bit

The brightness object sends a 1-bit value on the bus. If the parametrised brightness threshold is not reached, an ON telegram can be transmitted. If the parametrised brightness threshold is exceeded, an OFF telegram can be transmitted. Inverted transmission can also be set.

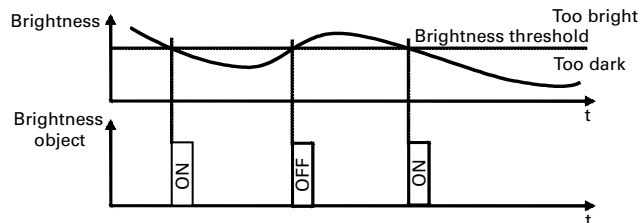

Always-dark object

In the case of an enabled "always-dark object", darkness can be simulated internally in the presence detector depending on the object value. The "always-dark object" is used with master/slave circuits. Planning master/slave circuits is described further below.

Communication objects

You can select the following communication objects:

Block X, general brightness:

Function	Object name	Type	Prio	Flags	Behaviour
Block X	Brightness threshold	2 bytes	Low	WC	Receive
Block X	Brightness object	1 bit	Low	CT	Transmit
Block X	Always-dark object	1 bit	Low	WC	Receive



Note:

The parameter settings include various functions which depend on other functions. Depending on the parameter setting, some functions or objects may or may not be displayed in the ETS.

Parameter

Block X, general brightness	
Parameter	Setting
Movement detection is	brightness-dependent independent of brightness
Brightness threshold adjustable via	Parameters IR configuration
Overwrite brightness threshold during download	Enabled Disabled
Brightness threshold (10 - 2000 lux) see "General" tab	10 - 2000 lux; preconfiguration: 130
Brightness threshold object	Disabled Enabled
Reaction when brightness sufficient despite movement	Like presence detector Like movement detector
Hysteresis (10% - 50%)	10 - 50%; preconfiguration: 25
Pause for measuring the brightness (1 - 120) seconds	1 - 120 seconds; preconfiguration: 4
Brightness object 1 bit	Do not send Transmit Transmit inverted
Always-dark object (= not brightness-dependent)	Disabled Enabled
Switch on at movement	Enabled Disabled

● **Operating modes**

The operating mode in which this block operates is specified in the application software for each block (movement/presence blocks 1 - 5). The following operating modes are available:

- Normal operation
- Master mode
- Slave mode
- Monitoring mode

Depending on the operating mode different parameters and communication objects will be displayed. Each operating mode can operate brightness-dependently or non-brightness-dependently.

Normal operation

In this operating mode the presence detector does not have any external trigger objects (master trigger object, trigger object). Telegrams cannot be sent cyclically and this means a master-slave system cannot be set up. In the default setting, the presence detector transmits an ON telegram at the start of movement and transmits an OFF telegram when the movement time (staircase timer) has expired.

i Note: Use the "Normal operation" setting when the movement/presence detector is working for itself alone. In other words, one presence detector is used for each room and it switches one light or one light panel.

Master mode

With master mode all of the possible parameters and communication objects of the presence detector are available. A master-slave system can be set up with the aid of the master trigger object or the trigger object. In the default setting, the presence detector transmits an ON telegram at the start of movement and transmits an OFF telegram when the movement time (staircase timer) has expired.

i Note: Use the "Master mode" setting when a master-slave system is to be set up. In other words, when, for example, several presence detectors are to be used in one room. One presence detector evaluates the brightness and functions as master, the other presence detectors work non-brightness-dependently as slaves and "drive" the master. Planning master/slave systems is described further below.

Slave mode

In slave mode the default setting is that ON telegrams are sent cyclically when a movement is detected. These telegrams are intended for the master trigger object or for the trigger object of the master.

i Note: Use the "Slave mode" setting when a master-slave system is to be set up. In other words, when, for example, several presence detectors are to be used in one room. One presence detector evaluates the brightness and functions as master, the other presence detectors work non-brightness-dependently as slaves and "drive" the master. Planning master/slave systems is described further below.

Monitoring mode

In monitoring mode the default setting is that ON telegrams are sent cyclically when a movement is detected. At the end of the movement time (cycle time with movement) OFF telegrams are transmitted cyclically.

i Note: Use the "Monitoring mode" setting when the presence detector is being used for room monitoring and telegrams are to be sent cyclically on the bus.

Communication objects

You can select the following communication objects:

Block X, general:

Function	Object name	Type	Prio	Flags	Behaviour
The objects are only visible in "Master mode" operating mode.					
Block X	Master trigger object	1 bit	Low	WC	Receive
Block X	Trigger object	1 bit	Low	WC	Receive

Parameter

Block X, general	
Parameter	Setting
Operating mode	Normal operation
	Master mode
	Slave mode
	Monitoring mode

i Note: When toggling between operating modes the "Brightness" and "Times" tabs change.

● **Telegrams**

For each presence/movement block the "Action at start of movement" can be set as a function of the operating mode.

Normal operation:

- "Send immediately"
- "Do not send"

Master mode:

- "Send immediately"
- "Send immediately and then cyclically"
- "Do not send"

Slave mode:

- "Send immediately and then cyclically" (is permanent setting in the background of the application software, is not displayed in the parameters)

Monitoring mode:

- "Send immediately and then cyclically" (is permanent setting in the background of the application software, is not displayed in the parameters)

The behaviour after the "End of movement time" can also be set as a function of the operating mode.

Normal operation:

- "Send after staircase timer/remaining time has elapsed"
- "Do not send"

Master mode:

- "Send after staircase timer/remaining time has elapsed"
- "Send after staircase timer has elapsed and then cyclically"
- "Do not send"

Slave mode:

- "Do not send" (is permanent setting in the background of the application software, is not displayed in the parameters)

Monitoring mode:

- "Send at end of cycle time when there is movement and then cyclically" (is permanent setting in the background of the application software, is not displayed in the parameters)

Four output objects are available for each of the five presence/movement blocks and they can be enabled via the application software. A transmission pause between the individual output objects can be set for each block.



Note:

Five presence/movement blocks and four output objects per presence detector means that 20 switching/value objects in all are available.

Parameter



Note:

The parameter settings include various functions which depend on other functions. Depending on the parameter setting, some functions or objects may or may not be displayed in the ETS.

Block X, general telegrams	
Parameter	Setting
Action at start of movement	Send immediately
	Do not send
	Send immediately and then cyclically
When movement time elapsed	Send after staircase timer/remaining time has elapsed
	Do not send
	"Send after staircase timer/remaining time has elapsed and then cyclically"
Output object X (1 - 4)	Enabled
	Disabled
Pause between two telegrams (3 - 255; preconfiguration: 5 - 255) x 100 ms	

Output for switching/value object X

For each output object you can select between a 1-bit, 1-byte (0% - 100%), 1-byte (0 - 255) and 2-byte object. The telegram values should be parametrised for the start of movement and for the end of the movement time. Here an object can transmit its current value or a defined value to the bus.



Note:

The current value can be transmitted by a time switch, for example. During the night a lower byte value is transmitted to the output object of the presence detector than in daytime hours.

Communication objects

You can select the following communication objects:

Block X general - telegrams - output for switching/value object X:

Function	Object name	Type	Prio	Flags	Behaviour
Block X	Switch object X	1 bit	Low	WCT	Transmit/receive
Block X	Value object X	1 byte	Low	WCT	Transmit/receive
Block X	Value object X	2 bytes	Low	WCT	Transmit/receive

Parameter

i Note:
 The parameter settings shown below are **dependent** on the operating mode and the object settings (1 bit, 1 byte or 2 bytes). Depending on the parametrisation some parameters will not be displayed!
 The parameter settings include various functions which depend on other functions. Depending on the parameter setting, some functions or objects may or may not be displayed in the ETS.

Block X general telegrams output switching/value object X	
Parameter	Setting
Object	1 bit
	1 byte 0% - 100%
	1 byte 0 - 255
	2 bytes
At start of movement	Transmits defined value Transmits its value
Value or object value	ON telegram
	OFF telegram
	0% - 100%
	0 - 255
	Change value 0 - 65535 to floating point
	Change value -32768 - 32767 to floating point
	Floating point
Value 0 - 65535	
Value -32768 - 32767	
When movement time elapsed	Transmits defined value Transmits its value
Value or object value	ON telegram
	OFF telegram
	0% - 100%
	0 - 255
	Change value 0 - 65535 to floating point
	Change value -32768 - 32767 to floating point
	Floating point
Value 0 - 65535	
Value -32768 - 32767	

i Note regarding 2-byte parameter settings:
 Depending on the setting of the object type value there will be new parameters; depending on the parametrisation the values can be input immediately or are determined via sign x basic value x factor.

● **Staircase timer**

The staircase timer or cycle time can be parametrised via a time base x factor. With "Normal operation" and "Master mode" operating modes the "Staircase timer" is parametrised. With "Slave mode" and "Monitoring mode" operating modes the "Cycle time" is parametrised.

i The "Times" tab has some parameter displays and selectable objects which are **dependent** on the operating mode set.

i Note:
 In "Slave mode" and "Monitoring mode" operating modes no further objects are displayed by modification on the "Times" tab.

Self-adjusting staircase timer

The presence detector is equipped with a "Self-adjusting staircase timer". When the "Self-adjusting staircase timer" is enabled, the presence detector can start a brief overshoot time when someone is in the room for a short time. If they remain in the room longer, a long overshoot time is started.
 The parameters "Time base", "Minimum time factor", "Time factor for learning step", "Maximum time factor" and "Sensitivity of the learning step" are available for the "Self-adjusting staircase timer." If there is only a brief movement in front of the presence detector, the overshoot time (until switch-off) will be close to the "Minimum time factor" x "Time basis". If movements last longer, a "Time factor for learning step" will be added to the staircase timer up to the maximum, depending on what learning sensitivity has been set. Once the time set on the staircase timer has elapsed, a restart takes place with "Minimum time factor".

Communication objects

Operating mode: Normal operation

You can select the following communication objects:

Block X, general times:

Function	Object name	Type	Prio	Flags	Behaviour
Block X	Time factor, staircase timer	1 byte	Low	WC	Transmit

Presence / monitoring / light control / IR - 1335/1.0

Parameter

Operating mode: Normal operation



Note:

The parameter settings include various functions which depend on other functions. Depending on the parameter setting, some functions or objects may or may not be displayed in the ETS.

Block X, general times	
Parameter	Setting
Via movement, time is	Retriggerable Not retriggerable
Staircase timer adjustable via	Parameters IR configuration
Overwriting staircase timer during download	Enabled Disabled
Self-adjusting staircase timer (always retriggerable)	Disabled Enabled
On reaching the switch-off threshold	Staircase timer elapsed Remaining running time elapsed
Time base, remaining running time	1 min 1 s 1 hr
Time factor, remaining running time (1 - 255)	1 - 255; preconfiguration: 4
The following settings are only visible when "Self-adjusting staircase timer" is "disabled".	
Time factor staircase timer object	Disabled Enabled
Time base, staircase timer	1 min 1 s 1 hr
Time factor for staircase timer (1 - 255)	1 - 255; preconfiguration: 25
The following settings are only visible when "Self-adjusting staircase timer" is "enabled".	
Minimum time factor (1 - 255) Staircase timer	1 - 255; preconfiguration: 5
Time factor for learning step (1 - 255) Staircase timer	1 - 255; preconfiguration: 1
Maximum time factor (1 - 255) Staircase timer	1 - 255; preconfiguration: 25
Sensitivity of learning step	1 - 5; preconfiguration: 4 1 = slow 5 = sensitive

Communication objects

Operating mode: Master mode

You can select the following communication objects:

Block X, general times:

Function	Object name	Type	Prio	Flags	Behaviour
Block X	Master trigger object	1 bit	Low	WC	Transmit
Block X	Trigger object	1 bit	Low	WC	Transmit

Function	Object name	Type	Prio	Flags	Behaviour
Block X	Time factor, staircase timer	1 byte	Low	WC	Transmit

Parameter

Operating mode: Master mode



Note:

The parameter settings include various functions which depend on other functions. Depending on the parameter setting, some functions or objects may or may not be displayed in the ETS.

Block X, general times	
Parameter	Setting
Master triggering is (brightness-dependent)	Enabled Disabled
Via movement/master trigger object, time is	Retriggerable Not retriggerable
Master trigger object includes the safety pause	Enabled Disabled
Triggering is (not brightness-dependent)	Enabled Disabled
Switch off staircase timer via trigger object	Enabled Disabled
Via trigger object, time is	Retriggerable Not retriggerable
Trigger object includes the safety pause	Enabled Disabled
Staircase timer adjustable via	Parameters IR configuration
Overwriting staircase timer during download	Enabled Disabled
Self-adjusting staircase timer (always retriggerable)	Disabled Enabled
The following settings are only visible when "Self-adjusting staircase timer" is "disabled".	
Time factor staircase timer object	Disabled Enabled
Time base, staircase timer	1 min 1 s 1 hr
Time factor for staircase timer (1 - 255)	1 - 255; preconfiguration: 25
The following settings are only visible when "Self-adjusting staircase timer" is "enabled".	
Minimum time factor (1 - 255) Staircase timer	1 - 255; preconfiguration: 5
Time factor for learning step (1 - 255) Staircase timer	1 - 255; preconfiguration: 1
Maximum time factor (1 - 255) Staircase timer	1 - 255; preconfiguration: 25
Sensitivity of learning step	1 - 5; preconfiguration: 4 1 = slow 5 = sensitive

Presence / monitoring / light control / IR - 1335/1.0

Block X, general times	
Parameter	Setting
On reaching the switch-off threshold	Staircase timer elapsed Remaining running time elapsed
Time base, remaining running time	1 min 1 s 1 hr
Time factor, remaining running time (1 - 255)	1 - 255; preconfiguration: 4

Communication objects

Operating mode: Slave mode



Note:

No objects for "Time factor" or objects for "Triggering" are displayed.
Exception: Slave as presence detector (brightness-dependent) - here a trigger object is offered as communication object.

Parameter

Operating mode: Slave mode

Block X, general times	
Parameter	Setting
Trigger object includes the safety pause	Enabled Disabled
Cyclic interval during movement	
Time base	1 min 1 s 1 hr
Time factor (1 - 255)	1 - 255; preconfiguration: 5

Communication objects

Operating mode: Monitoring mode



Note:

No objects for "Time factor" or objects for "Triggering" are displayed.

Parameter

Operating mode: Monitoring mode

Block X, general times	
Parameter	Setting
Cyclic interval during movement	
Time base	1 s 1 min 1 hr
Time factor (1 - 255)	1 - 255; preconfiguration: 5
Cyclic interval when movement time has elapsed	
Time base	1 s 1 min 1 hr
Time factor (1 - 255)	1 - 255; preconfiguration: 5

● Disable function

The presence detector can be disabled with the aid of the disable object; here the activation time point can be download / bus voltage recovery or reception of a disable telegram. The activation telegram for the disable function can be an ON telegram or an OFF telegram. At the start of disablement (if enabled via parameter) a telegram can be sent via the corresponding output object. Cyclic transmission makes sense with, for example, monitoring since certain bus devices require a cyclically transmitted OFF telegram. When the disable function is disabled, the current status of the presence detector is restored (an ongoing staircase timer is not stopped/start of movement actions or action when movement time elapses is transmitted).

Communication objects

You can select the following communication objects:

Block X, general:

Function	Object name	Type	Prio	Flags	Behaviour
Block X	Disable object	1 bit	Low	WC	Receive

Parameter

Block X, general	
Parameter	Setting
Disable function	Disabled Enabled

Block X, general - disable function

Parameter	Setting
Activation time point of disable function	Active during telegram reception After download / bus voltage recovery
Block	For object value "1" For object value "0"
Behaviour at the start of Telegrams block on Output object 1-4 tab	Do not transmit a telegram Transmit telegram
Behaviour at the start of Telegrams block on Output object 1-4 tab (only visible at master- or monitoring mode)	Transmit cyclic telegram
Time base	1 s 1 min 1 hr
Time factor (1 - 255)	1 - 255; preconfiguration: 30

Block X general telegrams output switching/value object X	
Parameter	Setting
At start of block	OFF telegram
	ON telegram
	1 byte 0% - 100%
	1 byte 0 - 255
	2 bytes floating point or value

i **Note regarding 2-byte parameter settings:** Depending on the setting of the object type value there will be new parameters; depending on the parametrisation the values can be input immediately or are ascertained via sign x basic value x factor.

● **Changing specific parameters via the bus**

The following parameters can be modified via the bus:

- "Time factor, staircase timer"
- "Range"
- "Brightness threshold"

i **Note:** Following bus voltage failure and recovery the modified values will be retained.

Communication objects

You can select the following communication objects:

Block X, general times:

Function	Object name	Type	Prio	Flags	Behaviour
Block X	Time factor, staircase timer	1 byte	Low	WC	Receive

Block X, general movement sensors:

Function	Object name	Type	Prio	Flags	Behaviour
Block X	Range	1 byte	Low	WC	Receive

Block X, general brightness:

Function	Object name	Type	Prio	Flags	Behaviour
Block X	Brightness threshold	2 bytes	Low	WC	Receive

Parameter

Block X, general times	
Parameter	Setting
Time factor staircase timer object	Disabled
	Enabled

Block X, general movement sensors	
Parameter	Setting
Range object (for all sensors)	Disabled
	Enabled

Block X, general brightness	
Parameter	Setting
Brightness threshold object	Disabled
	Enabled

● **Master/slave planning via the trigger object or master trigger object**

General information regarding the trigger object and master trigger object

The trigger object acts on the staircase timer **without** brightness measurement. Object value "1" starts the staircase timer (start of movement action) while further "1" telegrams retrigger the staircase timer, if enabled.

Object value "0" can switch the staircase timer off (end of movement time action), if enabled.

The master trigger object acts on the staircase timer **with** brightness measurement. Object value "1" starts the staircase timer (start of movement action) while further "1" telegrams retrigger the staircase timer, if enabled.

Object value "0" has no meaning as regards the master trigger object.

The parameters "Trigger object observes the safety pause" (enabled/disabled) and "Master trigger object observes the safety pause" (enabled/disabled) determine the effect of the safety pause on the two external trigger objects.

Application example 1: Slave as movement detector (not brightness-dependent) and master as movement detector (not brightness-dependent)

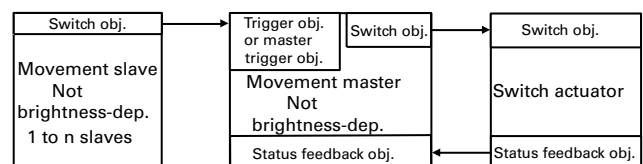

- System not brightness-dependent
- Slave transmits ON telegrams cyclically after movement
- Master switches on actuator when movement detected or trigger

Presence / monitoring / light control / IR - 1335/1.0

- Master retriggers staircase timer when movement detected or trigger
- Master switches off when staircase timer elapses
- Cycle time slave maximum staircase timer / 2
- Staircase timer retriggerable via movement / master trigger / trigger

Application example 2: Slave as movement detector (not brightness-dependent) and master as movement detector (brightness-dependent)

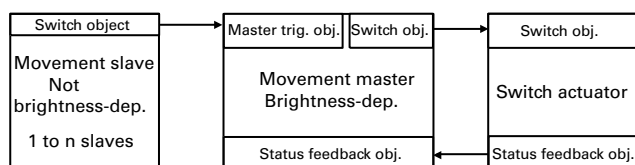

- Master evaluates brightness locally
- Slave transmits ON telegrams cyclically after movement
- Master switches on actuator upon movement detection or master trigger if it is too dark
- Master retriggers staircase timer upon movement detection or trigger, if previously switched on
- Master switches off when staircase timer elapses
- Cycle time slave maximum staircase timer / 2
- Staircase timer retriggerable via movement / master trigger / trigger

Application example 3: Slave as movement detector (brightness-dependent) and master as movement detector (brightness-dependent)

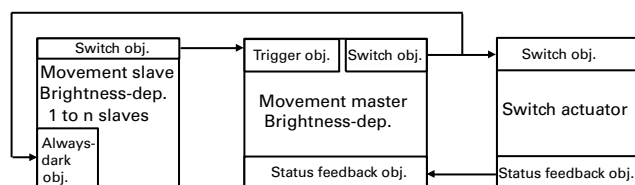

- Master and slave evaluate the brightness
- Slave sends ON telegrams cyclically upon movement detection if it is too dark or "Always-dark object" is "1".
- Master switches on actuator upon movement detection, if it is too dark
- Master switches on actuator upon trigger
- Master retriggers staircase timer upon movement detection or trigger, if previously switched on
- Master switches off when staircase timer elapses (always-dark object again "0")

- Cycle time slave maximum staircase timer / 2
- Staircase timer retriggerable via movement / master trigger / trigger

Application example 4: Slave as movement detector (not brightness-dependent) and master as presence detector (brightness-dependent)

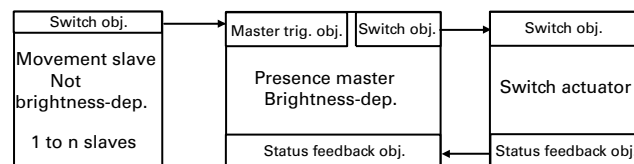

- Master evaluates brightness locally
- Slave transmits ON telegrams cyclically after movement
- Master switches on actuator upon movement detection or master trigger if it is too dark
- Master retriggers staircase timer upon movement detection or trigger, if previously switched on and the ambient brightness is not too high
- Master switches off when staircase timer elapses or ambient brightness is high enough
- Cycle time slave maximum staircase timer / 2
- Staircase timer retriggerable via movement / master trigger / trigger

Application example 5: Slave as presence detector (brightness-dependent) and master as presence detector (brightness-dependent)

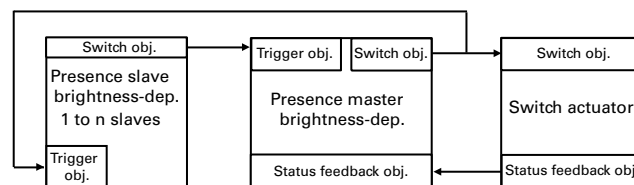

- Master and slave evaluate the brightness
- Slave sends ON telegrams cyclically upon movement detection if it is too dark and the ambient brightness in the activated state is not too high
- Master switches on actuator upon movement detection, if it is too dark
- Master switches on actuator upon trigger
- Master retriggers staircase timer upon movement detection if previously switched on and the ambient brightness is not too high
- Master retriggers staircase timer with trigger

- Master switches off when staircase timer elapses or ambient brightness is high enough
- Cycle time slave maximum staircase timer / 2
- Staircase timer retriggerable via movement / master trigger / trigger

● IR receiver configuration

The following IR receiver functions are available for the presence detector:

- Toggle (1 bit; 1 byte)
- Switch (1 bit; 1 byte)
- Dim (1 button; 2 buttons)
- Blind (1 button; 2 buttons)
- Edge function (1 bit; 1 byte)
- Edge function (with 2-byte values)
- Scene activation

For each IR function channel (1 - 10) the corresponding functions can be parametrised with the ETS. Each channel has the same range of functions.

Covering all functions the corresponding IR channel (1 - 50) of a remote control unit must be selected to which the IR function should react.

Toggle function (1 bit; 1 byte)

With the toggle function, when an IR remote control button is pressed an ON or OFF telegram will be sent alternately via the switch object. There is also the possibility of sending 1-byte values (0 - 100% or 0 - 255) via the value object.

Switch function (1 bit; 1 byte)

With the switch function when an IR remote control button is pressed an ON or OFF telegram will be sent via the switch object. There is also the possibility of sending 1-byte values (0 - 100% or 0 - 255) via the value object.

Brighter and darker dimming function (1 button)

When an IR remote control button is briefly pressed, an ON or OFF telegram will be sent from the switch object. If an IR remote control button is held down longer (more than the parametrisable actuation time) dimming up or down takes place via the 4-bit dimming object (the dimming steps can be parametrised). The current switching/dimming direction is always dependent on the previous action. A corresponding stop telegram is transmitted after a dimming procedure. After dimming up, the next time an IR remote control button is held down for a longer period, dimming down will be the result. The device also receives telegrams via the switch and dimming object. Depending on the values received, the next time the button is pressed the corresponding telegram will be generated (when switching object = "0" then switching on/dimming up occurs and when switching object = "1" then switching off/dimming down occurs). In addition, you can also transmit the

corresponding dimming step cyclically for a parametrisable period of time. In a system where several sensors activate an actuator, make sure that the switching and dimming object can also listen (same group address for all switching objects and all dimming objects / group addresses also listening).

Brighter and darker dimming function (2 button)

When an IR remote control button is briefly pressed, an ON or OFF telegram will be transmitted from the switch object depending on the parametrisation. If an IR remote control button is held down longer (more than the parametrisable actuation time) the 4-bit dimming object controls dimming up or down (the dimming steps can be parametrised). In addition, you can also transmit the corresponding dimming step cyclically for the time period of your choice. When the button is released after being held down for a long time a stop telegram can be transmitted if required. The time point from which a button press is recognised as long can be parametrised in steps of 100 ms.

Blind function up and down (1 button)

The current direction of movement of the blinds/roller shutters or the direction of the slat adjustment is always dependent on the previous action. For example after an UP command has been transmitted, a DOWN command will be generated after the IR remote control button has been held for a long time (longer than the parametrisable time). If additional stop/step telegrams are generated by briefly pressing the IR remote control button within a parametrisable time after a stop/step telegram has already been transmitted, they will rotate the slats in the same direction (after downward direction --> step upward and vice versa). The direction of slat rotation changes when an IR remote control button is pressed briefly only after the parametrised time has elapsed. The sensor also receives telegrams via the movement object and the stop/step object. Depending on the received values, the corresponding telegram is generated with the next action at the IR remote control button. In a system where several sensors activate an actuator, make sure that the switching and dimming object can also listen (same group address for all switching objects and all dimming objects / group addresses also listening).

Blind function up and down (2 buttons)

After pressing an IR remote control button briefly, a stop/step telegram is generated. After a long press (longer than the parametrisable actuation time) a movement telegram is generated. The direction of movement can be parametrised. The time point from which a button press is recognised as long can be parametrised in steps of 100 ms.

Edge function (1 bit; 1 byte)

The edge function provides the option of carrying out different actions at different times. The time points are: immediately upon actuation (actuated), release before elapse of long actuation time (briefly actuated), actuation reaching the long actuation time (long actuated) and release after the long actuation time has elapsed (release). At each of these times these actions can be carried out: transmit "Value 1", transmit "Value 2", transmit "own value" (current object value), toggle (between Value 1 and Value 2), or no action.

The edge function makes a 1-bit or a 1-byte communication object available.

The time point from which a button press is recognised as long can be parametrised in steps of 100 ms.

Note:

The actions carried out are dependent on actuation - in other words, with a brief actuation (duration of actuation is less than the set period of actuation) the actions "Upon actuation" and "With brief actuation" are carried out. With long actuation, on the other hand, the actions "Upon actuation", "With long actuation" and "Upon release" are carried out. In other words all actions need to be parametrised so that every actuation of the IR remote control button is followed by the action desired.

Edge function (with 2-byte values)

The edge function with 2-byte values is the same as the edge function with 1 bit, 1 byte, except that here a 2-byte communication object is made available. The values to be set are direct 2-byte values or floating point values (positive and negative values).

- Values 0 - 65535 change into floating point / the value input is changed into base and factor and sent on the bus.
- Values -32768 - 32767 change into floating point / the value input is changed into base and factor and sent on the bus.
- Floating point
- Value 0 - 65535 the value is transmitted unchanged to the bus
- Value -32768 - -32767 the value is transmitted unchanged to the bus

Scene activation

The scene function opens and saves scenes with 1-byte values (external scene modules). With the scene function, a scene is opened by pressing the IR remote control button briefly. Pressing the push-button for a long time saves a scene. The Saving scenes function can be disabled.

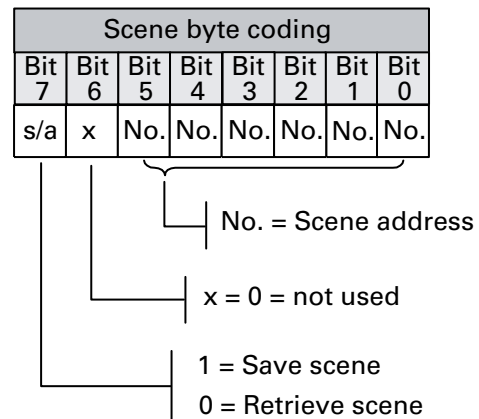

Communication objects

You can select the following communication objects:

IR receiver IR function X

Function	Object name	Type	Prio	Flags	Behaviour
IR receiver IR function (toggle function)	Switch object IR function X	1 bit	Low	WCT	Transmit/receive
IR receiver IR function (switch function)	Switch object IR function X	1 bit	Low	CT	Transmit
IR receiver IR function (dimming function lighter and darker)	Switch object IR function X	1 bit	Low	WCT	Transmit/receive
IR receiver IR function (dimming function lighter and darker)	Dimming object IR function X	4 bit	Low	WCT	Transmit/receive
IR receiver IR function (dimming function lighter or darker)	Switch object IR function X	1 bit	Low	CT	Transmit
IR receiver IR function (dimming function lighter or darker)	Dimming object IR function X	4 bit	Low	CT	Transmit
IR receiver IR function (blind function)	Movement object IR function X	1 bit	Low	CT	Transmit

Presence / monitoring / light control / IR - 1335/1.0

Function	Object name	Type	Prio	Flags	Behaviour
IR receiver IR function (blind function)	Stop/step object IR function X	1 bit	Low	CT	Transmit
IR receiver IR function (edge function)	Switch object IR function X	1 bit	Low	WCT	Transmit/receive
IR receiver IR function (edge function)	Value object IR function X	1 byte	Low	WCT	Transmit/receive
IR receiver IR function (edge function (2 byte))	Value object IR function X	2 byte	Low	WCT	Transmit/receive
IR receiver IR function (scene)	Scene object IR function X	1 byte	Low	CT	Transmit

Parameter



Note:

The parameter settings include various functions which depend on other functions. Depending on the parameter setting, some functions or objects may or may not be displayed in the ETS.

IR receiver	
Parameter	Setting
IR receiver function	Disabled Enabled
Function X (1 - 10)	Disabled Enabled

IR function X		
Parameter	Setting	
IR channel 1 - 50	1 - 50	
Function selection	Toggle	
	Switch 1 bit; 1 byte values	
	Dim	
	Blind	
	Edges 1 bit; 1 byte values	
The following settings are visible when the "Toggle" function selection has been made.	Edges with 2 byte values	
	Scene	
	Object	1 bit 1 byte 0% - 100% 1 byte 0 - 255
	Value 1 (0% - 100%)	0% - 100%, in 5% steps; preconfiguration: 100%
	Value 2 (0% - 100%)	0% - 100%, in 5% steps; preconfiguration: 0%
Value 1 (0 - 255)	0 - 255; preconfiguration: 255	
Value 2 (0 - 255)	0 - 255; preconfiguration: 0	
The following settings are visible when the "Switch" function selection has been made.	Object	1 bit 1 byte 0% - 100%

IR function X		
Parameter	Setting	
Value	1 byte 0 - 255	
	ON telegram OFF telegram	
	Value (0% - 100%)	0% - 100%, in 5% steps; preconfiguration: 100%
Value (0 - 255)	0 - 255; preconfiguration: 255	
The following settings are visible when the "Dim" function selection has been made.		
Detection of long actuation time 100 ms x factor (8 - 250)	8 - 250; preconfiguration: 8	
Dimming direction	Brighter and darker Brighter Darker	
	Dimming levels (brighter)	1/2 brighter; 1/4 brighter; 1/8 brighter; 1/16 brighter; 1/32 brighter; 1/64 brighter; preconfiguration: To max. brightness
	Dimming steps (darker)	1/2 darker; 1/4 darker; 1/8 darker; 1/16 darker; 1/32 darker; 1/64 darker; preconfiguration: To min. brightness
Cyclical transmission of dimming levels	Disabled Enabled	
	Stop telegram after release (only visible when dim brighter or darker has been selected)	Enabled Disabled
The following parameters are only visible when the "Blind" function selection has been selected.		
Detection of long actuation time 100 ms x factor (8 - 250)	8 - 250; preconfiguration: 8	
Direction of movement	Up and down Up Down	
	Change of direction slat adjustment time 100 ms x factor (10 - 50) (only visible when blind up and down has been selected)	10 - 50; preconfiguration: 20
	The following parameters are only visible when the "Edges" function has been selected.	
Detection of long actuation time 100 ms x factor (8 - 250)	8 - 250; preconfiguration: 8	
Object	1 bit 1 byte 0% - 100% 1 byte 0 - 255	
	Direct action when actuated	Transmits value 1 Transmits value 2 Transmits its value Toggles None
		Action on release before the long actuation time has elapsed

Presence / monitoring / light control / IR - 1335/1.0

IR function X	
Parameter	Setting
Action when the long actuation time is reached	None Transmits value 1 Transmits value 2 Transmits its value Toggles
Action on release after the long actuation time has elapsed	None Transmits value 1 Transmits value 2 Transmits its value Toggles
Value 1	ON telegram OFF telegram
Value 2	OFF telegram ON telegram
Value 1 (0% - 100%)	0% - 100%, in 5% steps; preconfiguration: 100%
Value 2 (0% - 100%)	0% - 100%, in 5% steps; preconfiguration: 0%
Value 1 (0 - 255)	0 - 255; preconfiguration: 255
Value 2 (0 - 255)	0 - 255; preconfiguration: 0
The following parameters are only visible when the "Edges 2 bytes" function has been selected.	
Detection of long actuation time 100 ms x factor (8 - 250)	8 - 250; preconfiguration: 8
Direct action when actuated	Transmits value 1 Transmits value 2 Transmits its value Toggles None
Action on release before the long actuation time has elapsed	None Transmits value 1 Transmits value 2 Transmits its value Toggles
Action when the long actuation time is reached	None Transmits value 1 Transmits value 2 Transmits its value Toggles
Action on release after the long actuation time has elapsed	None Transmits value 1 Transmits value 2 Transmits its value Toggles
IR function values	
Value 1.2	Change value 0 - 65535 to floating point Change value -32768 - 32767 to floating point Floating point Value 0 - 65535 Value -32768 - 32767



Note regarding 2-byte parameter settings:

Depending on the setting of the type value there will be new parameters; depending on the parametrisation the values can be input immediately or are determined via sign x basic value x factor.



Note:

The parameter settings include various functions which depend on other functions. Depending on the parameter setting, some functions or objects may or may not be displayed in the ETS.

IR receiver IR function X	
Parameter	Setting
Scene address (0 - 63)	0 - 63
Learn scene	Enabled Disabled
Detection of a long actuation time 100 ms x factor (8 - 250)	8 - 250; preconfiguration: 30

● IR configuration

For IR configuration the functions "Range", "Time factor for staircase timer" and "Brightness" are available. For each IR configuration channel (1 - 10) the corresponding function can be parametrised with the ETS. The same functions can be selected for each channel. In addition, in the ETS the corresponding IR channel (1 - 50) of a IR remote control unit can be assigned to the corresponding IR configuration channel.

IR configuration acts internally - in other words, no additional group addresses need to be linked. Using the IR configuration, you can adjust the range in all presence/movement blocks and the light control provided the parameter "Range adjustable" for example - "Via IR configuration" has been enabled in the corresponding channels. The "Range - IR configuration X" object is an information object; it can, for example, be used to display the value of this object on a touch panel.



Note:

Which values should be changed via the IR configuration can be specified in the individual blocks and in the light control. The corresponding tabs for "Range", "Time factor for staircase timer" and "Brightness" must be set to "Via IR configuration".

Changing the range via IR configuration

Pressing an IR remote control button once increases or reduces the range in 10% steps within the limits of 10% to 100%. While doing this, the current range of the first block affected can be transmitted (but does not have to be) via the Range object (several blocks can be changed at the same time).

Changing the time factor for staircase timer via IR configuration

Pressing an IR remote control button once increases or reduces the staircase timer time factor by an increment of 1 within the limits of 1 to 255. While doing this, the current time factor of the first block affected can be transmitted (but does not have to be) via the Time factor staircase timer object (several blocks can be changed at the same time). The staircase timer time is calculated from time base x time factor.

Changing the brightness via IR configuration

Pressing an IR remote control button once saves the currently obtained brightness value or a parametrised value in the enabled blocks as a brightness setpoint or brightness threshold. While doing this, the value can be sent (but does not have to be) via the Brightness threshold object.

Communication objects

You can select the following communication objects:

IR receiver IR configuration X

Function	Object name	Type	Prio	Flags	Behaviour
IR configuration n	Range IR configuration X	1 byte	Low	CT	Transmit
IR configuration n	Time factor staircase timer IR configuration X	1 byte	Low	CT	Transmit
IR configuration n	Brightness threshold IR configuration X	2 bytes	Low	CT	Transmit

Parameter



Note:

The parameter settings include various functions which depend on other functions. Depending on the parameter setting, some functions or objects may or may not be displayed in the ETS.

IR receiver	
Parameter	Setting
IR configuration movement/presence detector	Disabled Enabled
Configuration X (1 - 10)	Disabled Enabled

IR configuration X	
Parameter	Setting
IR channel 1 - 50	1 - 50
Function selection	Range Time factor for staircase timer Brightness
Range	Increase Reduce
Time	Increase Reduce
Brightness threshold/setpoint value	Set via parameter value Set via actual value
Value (10 - 2000 lux)	10 - 2000; preconfiguration 500

● Light control

The lighting controller makes it possible to have presence- and brightness-dependent control of lighting. The lighting controller can be switched on either automatically by means of movement sensors or manually by a local push-button (master trigger object). The output interface of the lighting controller is connected to a KNX dimming actor or a KNX control unit. As output objects a 1-bit switch object, a 4-bit dimming object and two setpoints each of 1 byte are available. Do not enable the "Extended parameters" while familiarising yourself with the lighting controller software application.

Getting started quickly with light control

Once the application has been added to the ETS and "Light control" has been enabled on the "Block configuration" tab, light control will be displayed amongst the basic functions. This means that none of the "extended parameters" is enabled.

In practice light control can be implemented without making a change to the "Light control" parameters. The 1-bit switch output and the 4-bit dimming output are connected to the switch object or dimming object of the dimming actuator / control unit. As soon as the presence detector detects a movement and provided the ambient brightness is below the set brightness threshold, light control will start automatically. By default the staircase timer is set to 25 minutes (in this connection see the "Light control, times" tab). By default the dimming down time is set to 5 minutes (in this connection see the "Light control, Switching off in automatic mode" tab). If the presence detector detects no further movement, the time before the lighting is switched off is calculated by adding the staircase timer and the dimming-down time. In the default setting this yields a time of 30 minutes (25 min staircase timer + 5 min dimming-down time). The setpoint value for light control is specified in the "Brightness" tab. The default setting for this value is 300 lux. This value applies when "Actual value correction" has not been enabled for the installation location of the presence detector. Light conditions on the reference area (desk) are not the same as at the installation location. This means that when a brightness of 500 lux is required at the desk for example, the brightness **on the reference area** must be set to 500 lux. After this the brightness is measured at the installation location. This value measured at the installation location is parametrised in the ETS.

Block diagram for light control

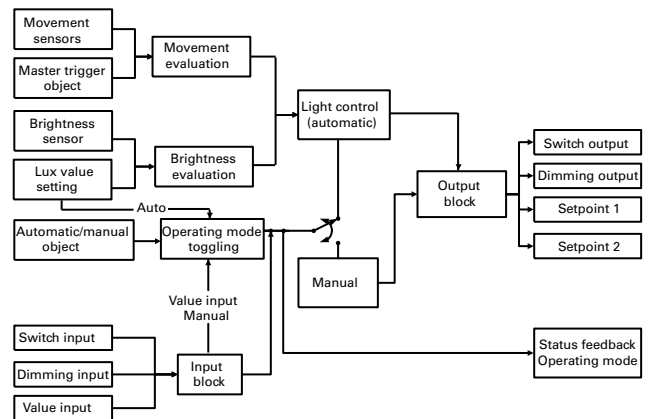

The output objects for light control are a 1-bit switch object, a 4-bit dimming object, two 1-byte value objects (setpoints 1 and 2). These output objects drive one or more dimming actuators or control units. The values transmitted to the output objects depend on the specified values of the input objects and the physical events (movement, ambient brightness in connection with the controller). The influence of the light control depends on the operating state (automatic or manual mode). If the presence detector is operating in automatic mode, the output objects will be directly affected by the light control. From the ambient brightness and the movement in front of the presence detector, the light control determines the values which are transmitted from the output objects. With the aid of the input objects the setpoint value of the controller can be moved and the operating state changed.

In manual mode the input telegrams of the input block are sent directly onward to the output objects. The operating state can also be changed here.

- Following description of the 1-byte value input, the operating state changes to manual mode. The value of the 1-byte input object is then directly forwarded to the output of the dimming actuator/control unit.
- Following description of the 2-byte lux value preset input, the operating state changes to automatic mode. The value of this input object specifies a new setpoint value for the light control. An exception is the value "0," which executes dimming-down.

By describing the master trigger object a movement is simulated. This object is ON-sensitive - in other words, only ON telegrams will result in movement simulation. OFF telegrams have no effect on the master trigger object.

Operating states

The light control can have two operating states:

- Manual mode
- Automatic mode

Which operating state will apply after download can be parametrised in the "Light control - general" tab. The operating state can also be changed by describing the automatic/manual object. Which input value changes to automatic mode can be parametrised in the "Light control - general" tab. In the default setting an object value of "0" will cause a switch into manual mode and an object value of "1" a switch into automatic mode. The operating mode feedback signal gives the current operating state and is sent following restoration of the bus voltage.

If the presence detector is in manual mode, light control is switched off - in other words, the light control does not transmit any telegrams to the 1-bit, 4-bit and 1-byte output objects. Movements detected in front of the sensor will not have any effect on the outputs either.

Incoming 1-bit switching telegrams, 4-bit dimming telegrams and telegrams at the 1-byte value input will be passed directly onward to the 1-bit, 4-bit and 1-byte outputs in question.

In automatic mode movement and brightness signals from the sensors are evaluated by the light control and result in telegrams being transmitted to the outputs. The 4-bit dimming telegrams and the 2-byte lux value setting are now used for moving the control threshold. Using the 1-byte value input, it is possible to switch to manual mode. This 1-byte value is forwarded from the output of the presence detector to the dimmer/control unit.

If the presence detector is in automatic mode the light control can be started by describing the 1-bit switch input.

The following table describes the change between manual and automatic mode during description of the 1-byte value input and the 2-byte lux value setting object:

Description of the ...	Operating state	Subsequent operating state	Feedback, operating mode
1-byte value input	Automatic mode	Manual mode	Is transmitted (value = "0")
1-byte value input	Manual mode	Manual mode	Is not transmitted
2-byte lux value setting	Automatic mode	Automatic mode	Is not transmitted
2-byte lux value setting	Manual mode	Automatic mode	Is transmitted (value = "1")s

Light control

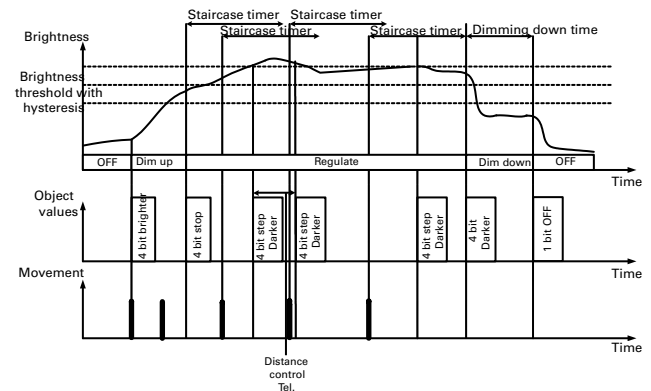

In the diagram the four phases of light control in automatic mode are described. The first phase is the idle state, when the lighting is switched off. In the second phase, the "dimming-up phase" (dimming up), the dimming actuator/control unit is dimmed via the output objects until the desired brightness threshold is reached. The actual regulating action does not occur until the third phase, the "control phase" (control). By means of its output telegrams the light control tries to keep the ambient brightness to a setpoint value using the dimming actuator/control unit. This setpoint value can be changed in this phase with 4-bit up/stop, 4-bit down/stop (dimming input) and 2-byte telegrams (not equal to 000 h) (lux value setting). In the fourth phase, the "dimming-down phase" (dimming down), the presence detector dims the dimming actuator/control unit from the setpoint value to the minimum brightness. Once this is reached, there will be a defined pause (see the dimming-down time parameter) before switch-off occurs.

Dimming up takes place via a 1/1 upward step. Once the brightness reaches the setpoint value (hysteresis band) due to the "dimming up" of the dimming actuator/control unit which now follows, a stop telegram is transmitted. From this time on, the ambient brightness is approximately held to the setpoint value by means of 1/n upward or downward steps. In the case of dimming actuators/control units with a steep and therefore a rapid build-up characteristic, overshooting will occur since the presence detector with light control cannot transmit the stop telegram fast enough.

As an alternative to dimming up with a 4-bit telegram a jump value can be parametrised. This is transmitted instead of the 1/1 step. This jump value is then used as point of departure for generating the control steps. Control steps are transmitted when the ambient brightness in the control phase does not correspond to the setpoint value (hysteresis band). Steps sized 1/8, 1/16, 1/32 or 1/64 can be selected. If several steps need to be sent successively this can be done in a parametrisable timing code (from 4 s). If 8, 16, 32 or 64 steps are transmitted in succession in one direction during the corresponding parametrisation, no more telegrams will be transmitted if dimming up has occurred. If dimming down has occurred there will be

a switch-off if this has been enabled by parameter. The dimming down process takes place by a 1/1 downward step. As a result the dimming actuator/control unit goes to its minimum brightness. Once the dimming-down time has elapsed, switching-off occurs following a 1-bit switching telegram. Alternatively, by means of a 1-bit switching telegram the light control can switch off immediately after the staircase timer elapses.

If the presence detector has switched off the lighting in Automatic mode, there are four ways of having the device dim up:

- The ambient brightness is below the current setpoint value and the movement sensor detects a movement in front of the device, or the master trigger object is described with an ON telegram.
- The ambient brightness is below the current setpoint value, the 1-bit switch input is described with an ON telegram and the parametrisation provides for this behaviour.
- By means of a 4-bit UP telegram at the dimming input the setpoint is shifted and simultaneously switched on.
- Value input on the lux value setting (not equal to 0) also causes dimming up with simultaneous shifting of the setpoint.
- Value input on the lux value setting (equal to 0) causes dimming-down behaviour.

The memory behaviour of the setpoint depends on the parametrisation in the application software. In this connection see the "Light control - general" tab, "Memory behaviour":

- "Last setpoint": After downloading, after bus voltage recovery and after a change of operating state (manual/automatic) the saved setpoint is used.
- "Parametrised setpoint value": After downloading, after bus voltage recovery and after a change of operating state (manual/automatic) the value parametrised with the application software is used.



Note:

A transition between two phases can have two causes: The presence detector evaluates a movement or the input objects are described. Example: If it has already switched off (phase: Off) the presence detector can switch automatically into the "Dimming up" phase due to a detected movement in order to set the ambient brightness close to the setpoint in the "Control" phase. The same transitions can also be made without movement by describing the input objects (1-bit switch input or 4-bit dimming input).

Movement detection

Movement detection with light control works similarly to movement detection with the presence detector. Also see above: "Presence/movement block" chapter under "Movement detection".

Actual value correction / extended control parameters

Enabling "Actual value correction" and "Extended control parameters" has effects on the enabling of some parameters with the light control. For more information on "Actual value correction," see the preceding chapter: "Brightness evaluation", topic: "Actual value correction".

The brightness sensor of the lighting controller measures the brightness at the installation location. This can be a problem for the lighting controller since there can be a brightness difference between the installation location and the reference area (location where the brightness value is to be controlled) as a function of the output variable of the dimming actuator/control unit. Actual value correction can be used for this problem case. Here a 1-byte status feedback object of the dimming actuator/control unit must be connected to the "Brightness value dimming actuator" status feedback object of the lighting controller.

Depending on the actual value correction and dimming-up, different control behaviours can be set.

Extended control parameters	Dimming-up behaviour	Status feedback	Control behaviour
Disabled	Relative dimming (4 bit)	Not available	Relative dimming (4 bit)
Disabled	Absolute value (1 byte)	Not available	Absolute value (1 byte) Relative dimming (4 bit)
Enabled	Relative dimming (4 bit)	From dimming actuator / control unit	Absolute value (1 byte) Relative dimming (4 bit)
Enabled	Relative dimming (4 bit)	From other source	Relative dimming (4 bit)
Enabled	Absolute value (1 byte)	From dimming actuator / control unit	Absolute value (1 byte) Relative dimming (4 bit)
Enabled	Absolute value (1 byte)	From other source	Absolute value (1 byte) Relative dimming (4 bit)
Enabled	Value (calculated, 1 byte)	From dimming actuator / control unit	Absolute value (1 byte) Relative dimming (4 bit)
Enabled	Value (calculated, 1 byte)	From other source	Absolute value (1 byte) Relative dimming (4 bit)

i Note:
The value calculated while dimming up (value calculated, 1 byte) for setpoint 1 is calculated using actual value correction (displacement curve) and the 1-byte status feedback from the dimming actuator/control unit. Once the setpoint has been set, the brightness should be close to the setpoint. This is why there is a short dimming-up phase.

i Note:
Actual value correction must be enabled or disabled in the "General" and "Light control - general" ("extended control parameters").

Extended dimmer properties

The "extended dimmer properties" are enabled or disabled in the tab "Switch on in automatic".

When "Extended dimmer properties" are enabled the objects "Dimming time reduction object" and "Load detection" can be parametrised.

Dimming time reduction object

The current dimmers and control units have a "Dimming time reduction" object (1 byte). This object is responsible for, among other things, parametrisation of the dimming curve. For more detailed information, see the application description for the dimmer or control unit.

A parametrisable time before the start of the dimming-up phase is transmitted to the "Dimming time reduction" object of the presence detector if the controller is started from the idle state or from manual mode. The value of this object sets a specific curve shape for the dimming actuator or control unit. This can be an advantage if the dimming curve has been changed manually at the dimming actuator: now the presence detector resets the optimal dimming curve for light control. In this way it is ensured that the optimal dimming curve shape is always set for light control.

Load detection

Universal dimmers (capacitive, inductive, ohmic) in many cases require load detection before they can start actually dimming. For light control, it is important to know when load detection must be started and when detection has finished. For this purpose, the error object of the light control which must be connected to the error object of the dimmer is displayed. In the case of bus voltage recovery or when an error is received at the error object, a load detection run can be triggered with the parametrised telegram. Once an OK has been received at the error object, light control can start.

In automatic mode load detection is triggered once when an error is received. In manual mode the presence detector "remembers" that load detection needs to be carried out later. This means that load detection is triggered in the "dimming-up phase".

i Note:
The error object of the dimming actuator affects all channels: in the case of open circuit, short circuit or overtemperature in a dimming channel, the error object transmits its value to the bus. A check should be made to see whether the corresponding dimming channel is being addressed via the light control.

Control response "absolute value" (1 byte)

Limit value telegrams

With the absolute value (1 byte) parametrised control response a telegram can be sent when the bottom and top control output limits are reached (crossed).

- 1 bit
An ON telegram is sent when the top / bottom limit is reached.
An OFF telegram is sent if an ON telegram has previously been sent and the control output is within the limits or when exiting the control phase.
- 1 byte
A parametrised telegram is transmitted when the top limit is reached.
A parametrised telegram is transmitted when the bottom limit is reached.

Control output 2

The second 1-byte control output can, for example, control a light strip close to the window in relation to a light strip further in the room (control output 1). The relationship between control output 2 and control output 1 can be absolute (control output 2 = control output 1 +/- X) or relative (control output 2 = control output 1 x X). For the control output limits for control output 1 and control output 2, during any 1-byte dimming-down behaviour make sure that the control output limits for control output 1 are not taken into consideration: At the same time, the value calculated for control output 2 must be included in the limit value consideration.

Light control with 2 levels

Two-level control can be used with enabled actual value correction and extended control parameters. With a 1-bit switch object, additional lighting can be switched if the setpoint cannot be reached via the dimmable luminaires.

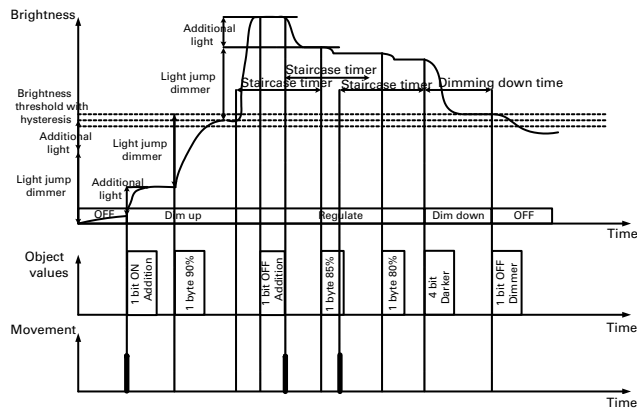

The additional lighting is switched on during the dimming-up phase since the dimmer alone cannot reach the setpoint value. The ambient brightness increases (abruptly) during the control phase, the dimmer alone cannot reach the setpoint value and the presence detector switches the additional lighting off. Unlike dimmable lighting, the additional lighting must contribute a considerably smaller proportion of the brightness so that the light control tend not to oscillate. The additional lighting would otherwise be continually switched on and off.

Changing specific parameters via the bus

The following parameters can be modified via the bus:

- "Time factor, staircase timer"
- "Range"
- "Brightness setpoint"



Note:

Following bus voltage failure and recovery the modified values will be retained.

Communication objects

You can select the following communication objects:

General light control

Function	Object name	Type	Prio	Flags	Behaviour
Light control	Switch output - control	1 bit	Low	CT	Transmit
Light control	Dimming output - control	4 bit	Low	CT	Transmit
Light control	Control output 1 - control	1 byte	Low	CT	Transmit
Light control	Control output 2 - control	1 byte	Low	CT	Transmit
Light control	Feedback, operating mode - control	1 bit	Low	CT	Transmit
Light control	Switch, additional lighting - control	1 bit	Low	CT	Transmit
Light control	Limit exceeded - control	1 bit	Low	CT	Transmit
Light control	Limit exceeded - control	1 byte	Low	CT	Transmit
Light control	Dimming time reduction object - control	1 byte	Low	CT	Transmit
Light control	Switch input - control	1 bit	Low	WCT	Transmit/ receive
Light control	Dimming input - control	4 bit	Low	WCT	Transmit/ receive
Light control	Value input - control	1 byte	Low	WCT	Transmit/ receive
Light control	Lux value setting - control	2 byte	Low	WCT	Transmit/ receive
Light control	Automatic/ manual object - control	1 bit	Low	WCT	Transmit/ receive
Light control	Master trigger object - control	1 bit	Low	WCT	Transmit/ receive
Light control	Range - (control)	1 byte	Low	WCT	Transmit/ receive
Light control	Time factor, staircase timer - (controller)	1 byte	Low	WCT	Transmit/ receive
Light control	Error object - (controller)	1 bit	Low	WCT	Transmit/ receive

Presence / monitoring / light control / IR - 1335/1.0

Parameter



Note:

The parameter settings include various functions which depend on other functions. Depending on the parameter setting, some functions or objects may or may not be displayed in the ETS.

General light control	
Parameter	Setting
Controller is	Dependent on movement and master trigger object Independent of movement Dependent on movement Dependent on master trigger object
Master trigger object includes the safety pause	Enabled Disabled
Operational status after bus voltage recovery	Automatic mode Manual mode
Automatic	For object value "1" For object value "0"
Memory behaviour	Last setpoint Parameterised setpoint value
Extended controller parameters (when actual value correction is enabled)	Disabled Enabled

General light control movement sensors	
Parameter	Setting
Sector-orientated settings	Disabled Enabled
The following parameters are only visible when "Sector-orientated settings" is "disabled".	
Sensitivity (for all sectors)	High Medium Low
Range (for all sensors)	10% - 100% (in 10% steps) preconfiguration: 100%
The following parameters are only visible when "Sector-orientated settings" is "enabled".	
Range object (for all sensors)	Disabled Enabled
Dead time, start of movement (for all sensors)	Disabled Enabled
Time base	1 min 1 s
Time factor (1 - 255)	1 - 255; preconfiguration: 3
Sector X	Enabled Disabled

General light control movement sensors sector X	
Parameter	Setting
Sensitivity	High Medium Low
Range adjustable via	Parameters IR configuration
Overwrite range during download	Enabled Disabled
Range	10% - 100%; preconfiguration: 100%
Change range via object	Disabled Enabled

Light control general manual/automatic transitions	
Parameter	Setting
On transition from manual to automatic mode	Wait for trigger condition if too dark Dim up if too dark
During transition from automatic to manual mode	Maintain status Switches off Dim down

Light control general switching on in automatic mode	
Parameter	Setting
Switch-on telegrams (1 bit)	Dim up or retrigger No response
Dimming-up behaviour	Relative dimming (4 bit) Absolute value (1 byte) Value (calculated, 1 byte) (not visible unless "Extended control parameters" "enabled")
Status feedback	From dimming actuator From other source
Dimming-up value format	Absolute Relative
Dimming-up value (10 - 255)	10 - 255; preconfiguration: 127
Dimming-up value (5% - 100%)	5% - 100%; preconfiguration: 50%
Extended dimmer properties	Disabled Enabled
Waiting time after-dimming up (12 - 255) seconds	12 - 255; preconfiguration: 12

Presence / monitoring / light control / IR - 1335/1.0

Light control general switching on in automatic mode dimmer properties	
Parameter	Setting
Dimming time reduction object	Disabled Enabled
Dimming time reduction (0% - 100%)	0% - 100%; preconfiguration: 100%
Time factor, pause (3 - 255) x 100 ms	3 - 255; preconfiguration: 5
Trigger load detection on bus voltage recovery or first error reception	Disabled Enabled
Failure in	For object value "1" For object value "0"
Load detection triggered by	Value telegram Dimming telegram Switching telegram
The following parameters are only visible when the "Load detection is triggered by" "Value telegram" has been parameterised.	
Value format	Absolute Relative
Value	0 - 255; preconfiguration: 127
Value	0% - 100%, (in 5% steps), preconfiguration: 50%
The following parameters are only visible when the "Load detection is triggered by" "Dimming telegram" has been parameterised.	
Dimming level	1/2 brighter - 1/64 brighter, to max. brightness, 1/2 darker - 1/64 darker, to min.brightness, preconfiguration: 1/2 brighter
The following parameters are only visible when the "Load detection is triggered by" "Switching telegram" has been parameterised.	
Value	ON telegram OFF telegram
Display of the parameters "Time basis" and time factor is independent of the telegram types set (value, dimming, switching).	
Time base, load detection	1 s 100 ms
Time factor, load detection (3 - 255)	3 - 255; preconfiguration: 14

Light control general control behaviour in automatic mode	
Parameter	Setting
Control output	Relative dimming (4 bit) Absolute value (1 byte)
Step width	1/8 - 1/64; preconfiguration: 1/32
Step width (2 - 32)	2 - 32; preconfiguration: 4
Reaction when the lower control output limit is reached	Retain value Switch off
Reaction when the control output limits are reached	None Transmit telegram
Control output 2 object	Disabled Enabled
Two-step controller (switching additional lighting)	Disabled Enabled

Light control general control response in automatic mode control value limits	
Parameter	Setting
Control output 1	
Format of lower control output limit	Absolute Relative
Lower control output limit (0 - 127)	0 - 127; preconfiguration: 0
Lower control output limit (0% - 50%)	0% - 50% (in 5% steps), preconfiguration: 0%
Format of upper control output limit	Absolute Relative
Upper control output limit (128 - 255)	128 - 255; preconfiguration: 255
Upper control output limit (50% - 100%)	50% - 100% (in 5% steps), preconfiguration: 100%
The following parameters are only visible when the "Control output 2 object" has been "enabled". (Tab: "Control response in automatic mode")	
Control output 2	
Control output 2 =	X% of control output 1 Control output 1 + X
X (1% - 200%)	1 - 200; preconfiguration: 90
X (-128 - 127)	-128 - 127; preconfiguration: -40
Format of lower control output limit	Absolute Relative
Lower control output limit (0 - 127)	0 - 127; preconfiguration: 0
Lower control output limit (0% - 50%)	0% - 50% (in 5% steps); preconfiguration: 0%
Format of upper control output limit	Absolute Relative
Upper control output limit (128 - 255)	128 - 255; preconfiguration: 255
Upper control output limit (50% - 100%)	50% - 100% (in 5% steps), preconfiguration: 100%

Presence / monitoring / light control / IR - 1335/1.0

Light control general control response in automatic mode telegram control output limits	
Parameter	Setting
Telegram	1 bit 1 byte
Reaction when the highest control output value is reached	Enabled Disabled
Value format	Absolute Relative
Value (0 - 255)	0 - 255; preconfiguration: 255
Value (0% - 100%)	0% - 100% (in 5% steps), preconfiguration: 100%
Reaction when the lowest control output value is reached	Enabled Disabled
Value format	Absolute Relative
Value (0 - 255)	0 - 255; preconfiguration: 0
Value (0% - 100%)	0% - 100%, in 5% steps, preconfiguration: 0%
Pause limit reached (1 - 255) seconds	0 - 255; preconfiguration: 1

Light control general control response in automatic mode times	
Parameter	Setting
Staircase timer adjustable via	Parameters IR configuration
Overwriting staircase timer during download	Enabled Disabled
Time base, staircase timer	1 min 1 s 1 hr
Time factor for staircase timer (1 - 255)	1 - 255; preconfiguration: 25
Time factor staircase timer object	Disabled Enabled
Staircase time is	Retriggerable Not retriggerable
Distance between control output telegrams (4 - 255) seconds	4 - 255; preconfiguration: 8

Light control general control response in automatic mode brightness	
Parameter	Setting
Setpoint adjustable via	Parameters IR configuration
Overwrite brightness setpoint during download	Enabled Disabled
Setpoint value (10 - 2000 lux) (installation location)	10 - 2000; preconfiguration: 300
Setpoint value (10 - 2000 lux) (reference area)	10 - 2000; preconfiguration: 500
Limit setpoint value adjustment?	Disabled Enabled
Max. upper setpoint value adjustment (10 - 2000 lux)	10 - 2000; preconfiguration: 2000
Max. lower setpoint value adjustment (10 - 2000 lux)	10 - 2000; preconfiguration: 10
Hysteresis (10% - 50%)	10 - 50; preconfiguration: 20

Light control general switching off in automatic mode	
Parameter	Setting
Reaction on receipt of switch-off telegram (1 bit)	Dim down and start of dimming-down time None Switch off immediately
Reaction when staircase timer has elapsed	Dim down and start of dimming-down time Switch off immediately
Reaction when dimming-down time has elapsed	Switch off Retain condition of dimming-down behaviour
While dimming down, triggering is	Possible through movement Not possible
Dimming-down behaviour	Relative dimming (4 bit) Absolute value (1 byte)
Dimming-down value format	Absolute Relative
Dimming-down value (0 - 255) (dimming-down behaviour)	0 - 255; preconfiguration: 0
Dimming-down value (0% - 100%) (dimming-down behaviour)	0% - 100%, in 5% steps, preconfiguration: 50%
Time base, dimming-down time	1 min 1 s 1 hr
Time factor, dimming-down time (1 - 255)	1 - 255; preconfiguration: 5

● Behaviour on application/recovery of the bus voltage

Behaviour on application/recovery of the bus voltage

The actual value input (external sensor), the status feedback object (brightness value dimming actuator) can transmit read requests depending on the parametrisation.

The operating mode status feedback message and the brightness object can be transmitted depending on the parametrisation.

Behaviour when bus voltage fails

No response

● Own notes: