

Product documentation

KNX Heating Act. FM w.3 Inputs
Art.-No. MTN6003-0005

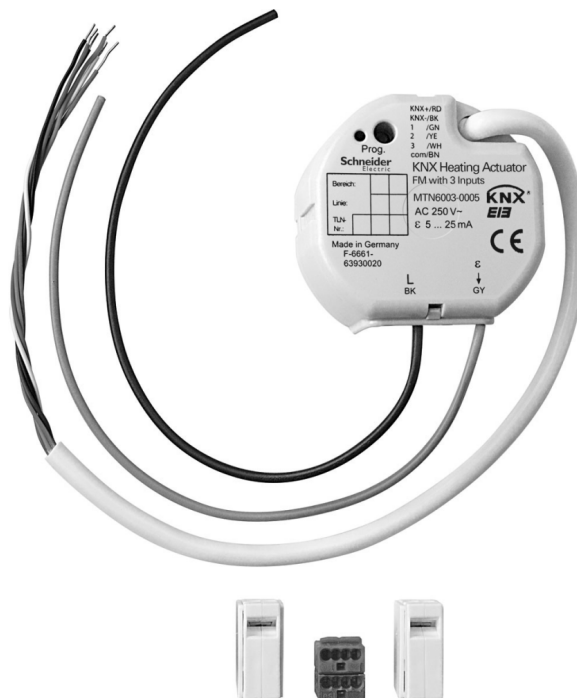

Contents

1	Product definition	3
1.1	Product catalogue	3
1.2	Function	3
2	Installation, electrical connection and operation	4
2.1	Safety instructions	4
2.2	Device components	5
2.3	Fitting and electrical connection	6
2.4	Commissioning	10
2.5	Operation	11
3	Technical data	12
4	Software description	13
4.1	Software specification	13
4.2	Software "Valve, input 20C011"	14
4.2.1	Scope of functions	14
4.2.2	Software information	16
4.2.3	Object table	17
4.2.3.1	Extension input objects	17
4.2.3.2	Valve output objects	20
4.2.4	Functional description	22
4.2.4.1	General functions for extension inputs	22
4.2.4.2	General functions for the valve output	23
4.2.4.3	Channel-orientated functions for extension inputs	24
4.2.4.3.1	Function configuration of the extension inputs	24
4.2.4.3.2	Disabling function for extension inputs	30
4.2.4.4	Channel-oriented functions for the valve output	31
4.2.4.4.1	General settings	31
4.2.4.4.2	Command value settings	40
4.2.4.4.3	Settings for the status function	52
4.2.4.5	Priorities for the output	58
4.2.5	Delivery state	59
4.2.6	Parameters	60
4.2.6.1	General parameters	60
4.2.6.2	Parameters for the extension inputs	62
4.2.6.3	Parameters for the valve output	74
5	Appendix	83
5.1	Index	83

1 Product definition

1.1 Product catalogue

Product name: KNX Heating Act. FM w.3 Inputs

Use: Actuator / sensor

Form: UP (concealed)

Art.-No. MTN6003-0005

1.2 Function

The device has one electronic switching output (O1), which allows silent control of electrothermal valve drives for heating or cooling systems. Up to 2 electrothermal valve drives can be connected to these electronic output, which is protected against overload and short-circuit.

The electronic switching output has the following scope of functions: conversion of constant command value telegrams into a pulse-width modulated output signal (PWM). This provides quasi-constant activation of the connected valve drives. Alternatively, conversion of switching command values. Status messaging for valve position and cyclical monitoring of the command value telegrams. Emergency operation in the event of bus voltage return and forced position via bus telegram in summer and winter mode. Alarm message in case of short-circuit or overload of the switching output and anti-sticking protection for the valves. Valve drives that are closed or open when deenergised can be connected. The status message "valve closed" can be transmitted to the bus for further processing or displaying the information on other bus devices.

Besides the output, the device possesses three additional inputs, which affect the KNX/EIB separately. The connected potential-free switch or button contacts are downloaded to the device via a shared reference potential. With the effect on the bus, the inputs can, independently of one another, transmit telegrams for switching or dimming for Venetian blind control or value encoder use (dimming value encoder, light scene extension). The connection of 230 V signals or other external voltages to the extension inputs is not permitted!

For configuration and commissioning of this device, it is necessary to use ETS3.0 from version "d" onwards. Advantages with regard to downloading (significantly shorter loading times) and parameter programming can be expected only if this ETS patch version or later versions are used.

The device electronics are supplied exclusively from the bus voltage. The device is designed for installation in concealed switch or device boxes in permanent installations.

2 Installation, electrical connection and operation

2.1 Safety instructions

Electrical devices may only be fitted and installed by electrically skilled persons. The applicable accident prevention regulations must be observed.

Failure to observe the instructions may cause damage to the device and result in fire and other hazards.

Before working on the device or exchanging the connected loads, disconnect it from the power supply (switch off the miniature circuit breaker), otherwise there is the risk of an electric shock.

The device is not suitable for disconnection from supply voltage.

Make sure during the installation that there is always sufficient insulation between the mains voltage and the bus and extension inputs. A minimum distance of at least 4 mm must be maintained between bus/extensions and mains voltage cores.

Do not connect any external voltage to the inputs, since doing so may damage the device(s), and the SELV potential on the KNX bus line will no longer be available.

Connect only electrothermal valve drives to the electronic switching output. Do not connect any inductive or capacitive loads.

Do not operate electrothermal valve drives with DC.

The connected actuators are not electrically isolated from the mains - even when switched off.

The device may not be opened or operated outside the technical specifications.

2.2 Device components

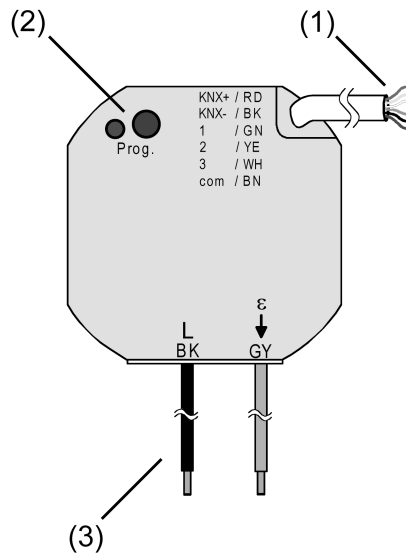

Figure 1: Device components

- (1) Control cable (bus connection and extension inputs)
- (2) Programming button and programming LED (red).
- (3) Connection cables for mains voltage and load

Connection assignment of the control cable (1)

RD (red): KNX bus voltage +
 BK (black): KNX bus voltage -
 GN (green): Input 1
 YE (yellow): Input 2
 WH (white): Input 3
 BN (brown): Reference potential "COM" for inputs 1...3

Connection assignment for mains voltage and load (3)

BK (black): Mains voltage (L)
 GY (grey): Connection for electrothermal actuators (ETA, ε) - electronic switching output

2.3 Fitting and electrical connection



DANGER!

Electrical shock when live parts are touched.

Electrical shocks can be fatal.

Before working on the device, disconnect the power supply and cover up live parts in the working environment.



DANGER!

When connecting the bus/extensions and mains voltage wires in a shared appliance box, the KNX bus line may come into contact with the mains voltage.

This endangers the safety of the entire KNX installation. People at remote devices may also receive an electric shock.

Do not place bus/extensions and mains voltage terminals in a shared connection compartment. Use an appliance box with a fixed partition wall or separate boxes.

Connecting and mounting the device

Minimum spacing between the mains voltage and bus/extension wires: 4 mm (Figure 2).

Recommendation: Use an electronics box when installing the device, e.g. with a series switch (Figure 3).

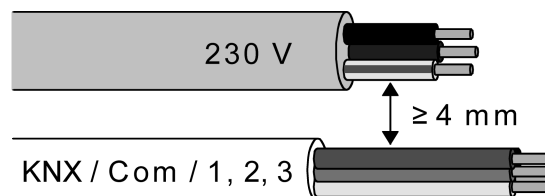

Figure 2: Minimum cable spacing

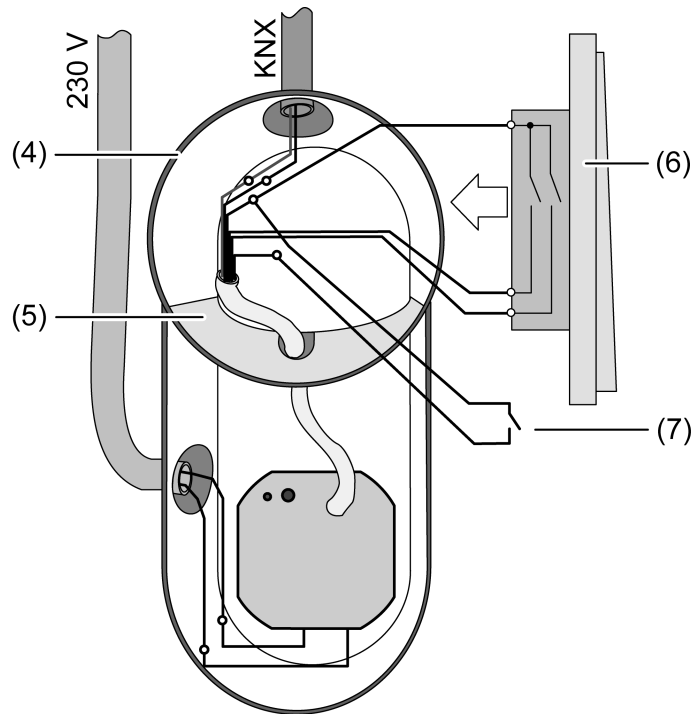

Figure 3: Installing the device in an electronics box (example)

- (4) Device box (e.g. electronics box)
- (5) Partition
- (6) Series switch
- (7) Potential-free contact, e. g. window contact

- Connect the mains voltage and electrothermal actuators using the included screwless terminals (Figure 4).

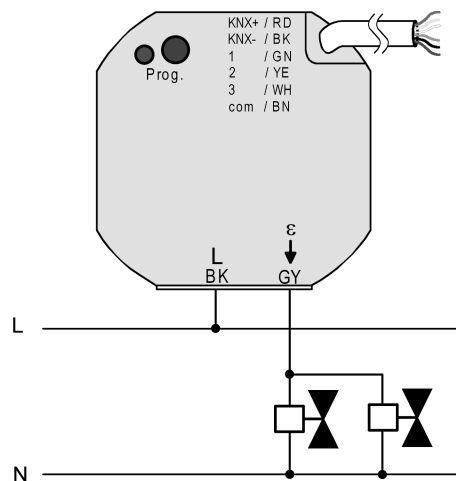

Figure 4: Connection of the mains voltage and the load

- Connect the device to KNX. For this, use a KNX connection terminal.
- If necessary, connect potential-free contacts to the inputs (Figure 5).
- i** Use suitable terminals to connect potential-free contacts to the control cable.

- i** The reference potential "com" may only be switched together with the reference potentials of other devices of the same type (!).

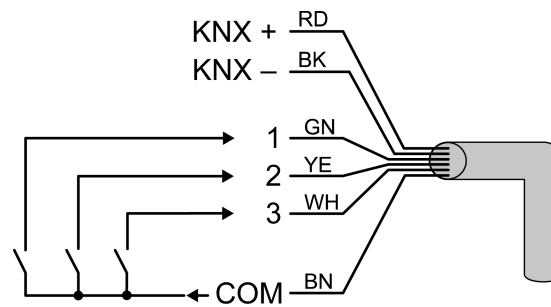

Figure 5: Connection of the extension inputs

- Install the device in a concealed box.
- i** Connect max. 2 electrothermal actuators to the electronic switching output. Do not connect any electric motor-driven actuators.
- i** When connecting the electrothermal actuators, pay attention to their direction of action (closed or open in deenergised state), and configure the device in the ETS accordingly. In the state as supplied the direction of action is preset to "closed when deenergised".
- i** Insulate unused wires of the 6-pin control cable against each other and outside voltage.
- i** To avoid interference from EMC radiation, the cables of the extension inputs should not be run in parallel to cables carrying voltage.

Use terminals

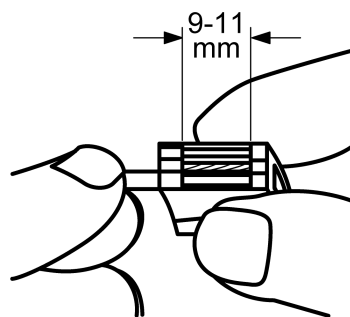

Figure 6: Stripping length

- Strip 9 - 11 mm of the cable (Figure 6).

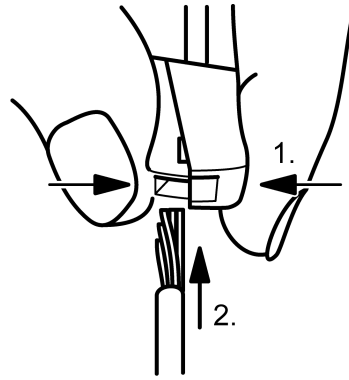

Figure 7: Connection of the fine-wire cable

- Push the terminal together on the side with the rectangular openings and connect the fine-wire connection cable of the device (Figure 7).

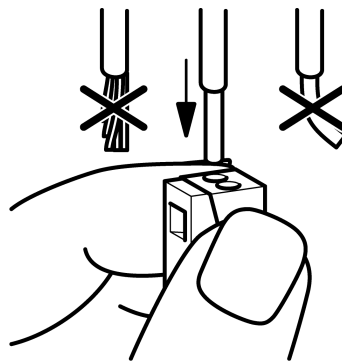

Figure 8: Connection of the single-stranded cable

- Push the single-stranded cable into the round opening on the installation side up to the stop (Figure 8).

2.4 Commissioning

Commissioning is basically confined to programming of the physical address and the application data with the ETS.

Commissioning with the ETS

Project planning and commissioning of the device using the ETS 3.0d with Patch A or newer versions.

The device is connected and ready for operation.

- Switch on the bus voltage
Check: When the programming button is pressed, the red programming LED must light up. Switching on the bus voltage causes the device carry out the "Behaviour after bus voltage return" configured in the ETS. In the state as supplied, this behaviour is set as follows for the output...
Close valve (Valve direction of action: deenergised closed = output OFF).
- Programming the physical address and the application data with the ETS.

2.5 Operation

After commissioning the device can only be controlled over the bus through communication objects. The control of the valve output is not possible in delivery state (unprogrammed device without ETS commissioning).

After commissioning using the ETS, extension inputs behaviour as they are configured in the ETS. It is possible to let the inputs internally effect the output by connecting the objects with identical group addresses. Alternatively, these inputs can also affect the bus and control other actuators. The extension inputs then function like standard KNX/EIB pushbutton interfaces.

3 Technical data

General

Mark of approval	KNX / EIB
Ambient temperature	-5 ... +45 °C
Storage/transport temperature	-25 ... +70 °C
Dimensions Ø×H	53×28 mm

KNX/EIB supply

KNX medium	TP 1
Commissioning mode	S-mode
Rated voltage KNX	DC 21 ... 32 V SELV
Power consumption KNX	max. 240 mW
Connection mode KNX	Connection terminal on control cable

Connection for mains voltage (L)

Connection mode	Terminal (enclosed)
Single stranded	1.0 ... 2.5 mm ²
Rated voltage	AC 230 / 240 V ~
Mains frequency	50 / 60 Hz

Output 2 (ETA output)

Connection mode	Terminal (enclosed)
Single stranded	1.0 ... 2.5 mm ²
Output type	Semi-conductor (Triac), ε
Switching voltage	AC 250 V~
Switching current	5 ... 25 mA
Switch-on current	max. 600 mA (2 sec)
Number of drives per output	max. 2

Inputs (I1, I2, I3)

Input type	Potential-free
Control cable (preterminated)	YY6x0.6
Total length of extension unit cable	max. 5 m
Loop resistance	max. 500 Ω

4 Software description

4.1 Software specification

ETS search paths: 4.5 Blind Actuator / 4.5.02 Flush-mounted UP / KNX Heating Act. FM w.3 Inputs

BAU used: ASIC FZE 1066 + μ C

KNX/EIB type class: Device with cert. Physical layer + stack

Configuration: S-mode standard

PEI type: "00"_{Hex} / "0"_{Dec}

PEI connector: No connector

Application programs:

No.	Short description	Name	Version	from mask version
1	Multifunctional application incl. valve control for heating or cooling systems. Additional comprehensive extension function.	Valve, input 20C011	1.1 for ETS3.0d onwards	705

4.2 Software "Valve, input 20C011"

4.2.1 Scope of functions

General

- 1 x electronic switching output (O1) for silent control of up to two electrothermal actuators (ETA) for heating or cooling systems. Conversion of switching or constant command value telegrams into a switching or pulse-width modulated output signal.
- 3 x extension inputs for potential-free contacts.
- No additional power supply required. The device electronics are supplied fully from the bus line.
- Actively transmitting feedback or status messages of the output can be delayed globally after bus voltage return or after ETS programming.
- The delay after bus voltage return can also be set generally for the inputs.
- Debounce time and telegram rate limit can be configured for the extension inputs.

Valve output (O1)

- Control either via a switching (1 bit) or alternatively via a constant (1 byte) command value telegram. Constant command values are converted via pulse width modulation at the output. The cycle time of the output signal can be configured.
- Status feedback (1 bit or 1 byte) possible automatically or on read request.
- Valve direction of action (open or closed in deenergised state) can be configured.
- Summer or winter mode can be selected via an object (polarity configurable).
- Cyclical monitoring of the command value can be set, taking into account a configurable monitoring time. If no telegram is received within the specified monitoring time, the output switches to emergency operation, and an alarm message can be transmitted to the bus (polarity can be configured).
- Forced position for activation of a fixed valve position configured in the ETS. Various valve positions can be preset for summer and winter mode. In forced operation, the electronic switching output cannot be controlled using the command values.
- If the command value is "OFF" or "0", the message "Valve closed" can be transmitted to the bus via an object. The telegram polarity of this status message can be configured in the ETS.
- Short-circuit and overload protection. Optionally with a separate alarm message to the bus (polarity can be configured).
- Anti-sticking protection for the connected valve drives.

Extension inputs (I1, I2, I3)

- With separate impact on bus:
 - Free allocation of the functions switching, dimming, Venetian blind and value encoder.
- Disable object for disabling individual inputs (polarity of the disable object is adjustable).
- Behaviour on bus voltage return can be configured separately for each input.
- Scope of detail for the "Switching" function:
 - Two independent switching objects available for each input (switching commands can be configured individually).
 - Command can be set independently for rising and falling flank (ON, OFF, TOGGLE, no reaction).
 - Independent cyclical transmission of the switching objects can be selected depending on the flank or depending on the object value.
- Scope of detail for the "Dimming" function:
 - Single-surface and double-surface operation possible.
 - Time between dimming and switching and dimming increments is adjustable.
 - Telegram repetition and stop telegram transmission possible.

- Scope of detail for the "Venetian blind" function:
Command can be set independently for rising flank (no function, UP, DOWN, TOGGLE).
Operation concept configurable (short – long – short or long – short).
Time adjustable between short-time and long-time operation (only for short – long – short)
Adjustable slat adjustment time (time during which a MOVE command can be terminated by releasing a pushbutton on the input).
- Scope of detail for the "Value encoder" function:
Flank (pushbutton as NO contact, pushbutton as NC contact, switch) and value for flank can be configured.
Value adjustment for pushbutton long key-press possible for value encoder.
For light scene extension with memory function, the scene can also be saved without prior recall.

4.2.2 Software information

ETS project design and commissioning

For configuration and commissioning of this device, it is necessary to use ETS3.0 from version "d" onwards. Advantages with regard to downloading (significantly shorter loading times) and parameter programming can be expected only if this ETS patch version or later versions are used. The advantages are gained through the use of the mask version 7.5.

The product database required for the ETS3.0 from version "d" or more recent versions is offered in the *.VD4 format. The corresponding application program has the version number "1.1".

Safe-state mode

If the device - for instance as a result of errors in the configuration or during commissioning - does not work properly, the execution of the loaded application program can be halted by activating the safe-state mode. The safe-state mode does not permit control of the outputs via the bus or evaluation of the inputs. The device remains passive since the application program is not being executed (state-of-execution: terminated). Only the system software is still functional so that the ETS diagnosis functions and also programming of the device continue to be possible.

Activating the safe-state mode

- Switch off the bus voltage (e.g. by disconnecting the device from the bus line).
- Press and hold down the programming button.
- Switch on the bus voltage (e.g. by connecting the device to the bus line). Release the programming button only after the programming LED starts flashing slowly.

The safe-state mode is activated. With a new brief press of the programming button, the programming mode can be switched on and off as usual also in the safe-state mode. The programming LED will nevertheless continue to flash independently of the programming mode as long as the safe-state mode is active.

- i** The safe-state mode can be terminated by switching off the bus voltage or by programming with the ETS.

Unloading the application program

The application program can be unloaded with the ETS. In this case the device is without function.

4.2.3 Object table

Number of communication objects:	17 (max. object number 86 - gaps in between)
Number of addresses (max):	254
Number of assignments (max):	255
Dynamic table management	Yes
Maximum table length	255

4.2.3.1 Extension input objects

Function: Switching

Object	Function	Name	Type	DPT	Flag
 10, 11, 12	Switching object X.1	Input 1 ... 3	1-bit	1.001	C, W, T ¹

Description 1-bit object for the transmission of switching telegrams (ON, OFF)
(first switching object)

Function: Switching

Object	Function	Name	Type	DPT	Flag
 14, 15, 16	Switching object X.2	Input 1 ... 3	1-bit	1.001	C, W, T ¹

Description 1-bit object for the transmission of switching telegrams (ON, OFF)
(second switching object)

Function: Dimming

Object	Function	Name	Type	DPT	Flag
 10, 11, 12	Switching	Input 1 ... 3	1-bit	1.001	C, W, T ¹

Description 1-bit object for the transmission of switching telegrams (ON, OFF) for the
dimming function.

Function: Dimming

Object	Function	Name	Type	DPT	Flag
 14, 15, 16	Dimming	Input 1 ... 3	4-bit	3.007	C, W, T ¹

Description 4-bit object for change of relative brightness between 0 and 100 %.

1: Each communication object can be read out. For reading, the R-flag must be set.

Function: Venetian blind

Object	Function	Name	Type	DPT	Flag
 10, 11, 12	Short time operation	Input 1 ... 3	1-bit	1.008	C, -, T ¹

Description 1-bit object for short-time operation of a blind.

Function: Venetian blind

Object	Function	Name	Type	DPT	Flag
 14, 15, 16	Long time operation	Input 1 ... 3	1-bit	1.007	C, W, T ¹

Description 1-bit object for long-time operation of a blind.

Function: Value encoder (dimming value encoder)

Object	Function	Name	Type	DPT	Flag
 10, 11, 12	Value	Input 1 ... 3	1 byte	5.001	C, -, T ¹

Description 1 byte object to transmit value telegrams (0 ... 255).

Function: Value encoder (temperature value encoder)

Object	Function	Name	Type	DPT	Flag
 10, 11, 12	Temperature value	Input 1 ... 3	2 byte	9.001	C, -, T ¹

Description 2-byte object for transmission of temperature value telegrams (0 °C ... 40 °C).

Function: Value encoder (brightness value encoder)

Object	Function	Name	Type	DPT	Flag
 10, 11, 12	Brightness value	Input 1 ... 3	2 byte	9.004	C, -, T ¹

Description 2-byte object for transmission of brightness value telegrams (0 Lux ... 1,500 Lux).

Function: Value encoder (light scene extension)

Object	Function	Name	Type	DPT	Flag
 10, 11, 12	Light scene extension	Input 1 ... 3	1 byte	18.001	C, -, T ¹

Description 1-byte object for opening or saving light scenes (1 ... 64).

1: Each communication object can be read out. For reading, the R-flag must be set.

Function: Disabling function

Object	Function	Name	Type	DPT	Flag
 18, 19, 20	Disabling switching object X.1	Input 1 ... 3	1-bit	1.003	C, S, - 1

Description 1-bit object for disabling the first switching object of an extension input (polarity configurable).
Only for the "Switching" function!

Function: Disabling function

Object	Function	Name	Type	DPT	Flag
 22, 23, 24	Disabling switching object X.2	Input 1 ... 3	1-bit	1.003	C, S, - 1

Description 1-bit object for disabling the second switching object of an extension input (polarity configurable).
Only for the "Switching" function!

Function: Disabling function

Object	Function	Name	Type	DPT	Flag
 18, 19, 20	Disabling	Input 1 ... 3	1-bit	1.003	C, S, - 1

Description 1-bit object for disabling an extension input (polarity configurable).
Only for the "Dimming", "Venetian blind" and "Value encoder" functions.

1: For reading, the R-flag must be set. The last value written to the object via the bus will be read.

4.2.3.2 Valve output objects

Function: Command value

Object	Function	Name	Type	DPT	Flag
 ⁶²	Command value	Output 1	1-bit	1.001	C, S, - ¹

Description 1-bit object to specify a switching command value of a room temperature controller.

Function: Command value

Object	Function	Name	Type	DPT	Flag
 ⁶²	Command value	Output 1	1 byte	5.001	C, S, - ²

Description 1-byte object to specify a permanent command value of a room temperature controller.

Function: Command value status

Object	Function	Name	Type	DPT	Flag
 ⁶³	Command value status	Output 1	1-bit	1.001	C, -, T ³

Description 1-bit object to transmit or read out status telegrams on the current target valve position value for switching command values
"Valve opened" = "1" / "Valve closed" = "0".

Function: Command value status

Object	Function	Name	Type	DPT	Flag
 ⁶³	Command value status	Output 1	1 byte	5.001	C, -, T ³

Description 1-byte object to transmit or read out status telegrams on the current target valve position value for permanent command values (0...255).

Function: Forced position

Object	Function	Name	Type	DPT	Flag
 ⁶⁴	Forced position	Output 1	1-bit	1.001	C, S, - ¹

Description 1-bit object for forced control of the valve output.
("1" = Forced position active / "0" = Forced position inactive).

1: For reading, the R-flag must be set. The last value written to the object via the bus will be read.

2: The communication flags are set automatically depending on the configuration. "T" flag for active object; "R" flag for passive object.

3: Each communication object can be read out. For reading, the R-flag must be set.

Function: Short-circuit / overload

Object	Function	Name	Type	DPT	Flag
 ⁶⁵	Short-circuit / overload alarm	Output 1	1-bit	1.005	C, -, T ¹

Description 1-bit object for the overload or short-circuit message of the valve output to the bus. The object remains active (configurable polarity) until the overload or short-circuit has been removed.

Function: Command value monitoring

Object	Function	Name	Type	DPT	Flag
 ⁶⁶	Command value monitoring alarm	Output 1	1-bit	1.005	C, -, T ¹

Description 1-bit object for signalling that command values have not appeared during the monitoring time and emergency operation was activated (configurable polarity).

Function: Command value limit

Object	Function	Name	Type	DPT	Flag
 ⁶⁷	Command value limit	Output 1	1-bit	1.001	C, S, - ²

Description 1-bit object to activate and deactivate the command value limit ("0" = Command value limit inactive / "1" = Command value active). The object value can be configured in the ETS after a device reset.

Function: Valve check

Object	Function	Name	Type	DPT	Flag
 ⁸⁵	Valve closed	Output 1	1-bit	1.002	C, -, T ¹

Description 1-bit object to display the command value "OFF" (1-bit) or "0" (1-byte) and that the valve is closed (configurable polarity).

Function: Summer/winter mode switchover

Object	Function	Name	Type	DPT	Flag
 ⁸⁶	Summer/winter switchover	Output 1	1-bit	1.001	C, S, - ²

Description 1-bit object to switch over between summer and winter mode (polarity and preference value can be configured after an ETS programming operation).

1: Each communication object can be read out. For reading, the R-flag must be set.

2: For reading, the R-flag must be set. The last value written to the object via the bus will be read.

4.2.4 Functional description

4.2.4.1 General functions for extension inputs

Delay after bus voltage return

It is possible to specify separately for each input whether a reaction should take place after a device reset (bus voltage return or ETS programming operation). This means that a defined telegram can be transmitted to the bus according to the input signal or with forced control. The configured "Delay after bus voltage return" for the extension inputs on the "General" parameter page must have elapsed fully by the time the set reaction is executed. Within the delay, any pending flanks or signals at the inputs are not evaluated and are ignored. The delay time is configured generally for all the inputs. In the as-delivered state of the device, the time is preset to "0 s".

Telegram rate limit

It is possible to configure a general telegram rate limit using the parameter of the same name on the "General" parameter page. If the telegram rate limit is enabled, no more telegrams are transmitted to the bus in 17 seconds (permanently defined, cyclical time interval) than is specified in the ETS. This avoids fast flank changes at the inputs causing an unpermissibly high bus load.

- i** A telegram rate limit does not influence a configured delay after bus voltage return. These two functions can be combined in any way.

4.2.4.2 General functions for the valve output

Delay after bus voltage return

To reduce telegram traffic on the bus line after bus voltage activation (bus reset), after connection of the device to the bus line or after programming with the ETS, it is possible to delay all actively transmitted feedback telegrams of the actuator output. For this purpose, a channel-independent delay can be specified for the output 1 using the parameter "Delay after bus voltage return" on the "General" parameter page. Only after the configured time elapses are feedback telegrams for initialisation transmitted to the bus.

Which of the telegrams is actually delayed and which is not can be specified for each signalling or status function separately.

- i** The delay has no effect on the behaviour of the output. Only the bus telegrams for feedback are delayed. The output can also be controlled over the bus during the delay after bus voltage return.
- i** A setting of "0" for the delay after bus voltage return deactivates the delaying function altogether. In this case, any messages, if actively transmitted, will be transmitted to the bus without any delay.

4.2.4.3 Channel-orientated functions for extension inputs

4.2.4.3.1 Function configuration of the extension inputs

The following section contains descriptions of the various functions that can be configured in the ETS independently for each input. The functions "Switching", "Dimming", "Venetian blind" or "Value encoder" can be set.

Switching function

For each input whose function is set to "Switching", the ETS displays two 1-bit communication objects (switching object X.1 and X.2). It is possible to use these two objects to transmit different switching telegrams to the bus depending on the signal flank at the input. The input parameter on the parameter page "Ix - General " (x = 1, 2, 3) can be used to define which object value is transmitted to the bus when there is a rising or falling flank at the input (no reaction, ON, OFF, TOGGLE - switchover of the object value). No distinction is made between a brief or long signal flank/actuation in the "Switching" function.

Response to bus voltage return

After a device reset (bus voltage return or ETS programming operation), the communication objects of the input can be initialised. For this, the "Behaviour on bus voltage return" parameter should be configured to the required reaction. In the settings "On telegram" or "Off telegram" telegrams are transmitted actively to the bus according to this requirement. In the "Transmit current input status" setting, the device evaluates the static signal status of the input and, according to this, transmits the appropriately configured telegram to the bus (contact closed at the input = telegram as with rising flank; contact open at input = telegram as with falling flank). If, in this case, the flank command dependent on the current status is configured to "No reaction", the device does not transmit a telegram to the bus on initialisation. If, in the ETS, a delay is set for the extension inputs after bus voltage return, the device only transmits the telegrams when the delay has elapsed.

Cyclical transmission

Optionally, the object values can be transmitted cyclically to the bus for the "Switching" function. For this, the transmission criteria must first be defined in the ETS. The "Transmit cyclically ?" parameter on the parameter page "Ix - Transmit cyclically" (x = 1, 2, 3) specifies with which value cyclical transmission should take place. Depending on requirements, it is possible to transmit cyclically via both or just one switching object(s). In addition, it is possible to define the cycle time separately for both switching objects in the ETS.

The object value entered in the switching objects by the device on a flank change or externally by the bus is always transmitted cyclically. The object value is then also transmitted cyclically when "no reaction" is assigned to a rising or falling flank. Cyclical transmission also takes place directly after bus voltage return, if the reaction after bus voltage return corresponds to the transmission criterion for cyclical transmission. During an active disable, no cyclical transmissions take place via the disabled input.

Dimming function

For each input whose function is set to "Dimming", the ETS indicates a 1-bit "Switching" and a 4-bit "Dimming" object. In general, the device transmits a switching telegram on a short time input signal (triggered by the rising flank of a closed contact) and a dimming telegram on a long signal. In the standard configuration, the device transmits a telegram for stopping the dimming action after a long signal.

The length of time the input signal (closed pushbutton or switch) must last until a long actuation is detected can be set using the parameter "Time between switching and dimming" on the parameter page "Ix - General" (x = 1, 2, 3).

Operating principle

The "Operation" parameter specifies the operating principle. In the presetting of the dimming function, two-surface operation is specified here. This means that the input transmits a telegram for switching on after a short signal length and a telegram for increasing the brightness after a long signal length ("Brighter"). Alternatively, the device can transmit a telegram for switching off after a short signal length and a telegram for reducing the brightness after a long signal length ("Darker").

With a single-surface dimming function, the input transmits switch-on and switch-off telegrams ("TOGGLE") in an alternating pattern for each short signal. After long signals, the device transmits "brighter" and "darker" telegrams in an alternating pattern.

- i** With single-surface dimming, the following should be observed: if a dimming actuator is to be controlled from several locations, a faultless single-surface operation requires that the addressed actuator reports its switching state back to the 1-bit object of the input and that the 4-bit objects of all the sensors are interlinked. The sensor device would otherwise not be able to detect that the actuator has been addressed from another sensor, in which case it would have to be actuated twice during the next use in order to produce the desired reaction.

The additional input parameters on the parameter page "Ix - General" can be used to specify in which increments brighter or darker dimming take place, whether a stop telegram is transmitted on a falling flank or whether the dimming telegram is to be repeated cyclically.

Response to bus voltage return

After a device reset (bus voltage return or ETS programming operation), the communication object "Switching" of the input can be initialised. For this, the "Behaviour on bus voltage return" parameter should be configured to the required reaction. In the settings "On telegram" or "Off telegram" telegrams are transmitted actively to the bus.

If, in the ETS, a delay is set for the extension inputs after bus voltage return, the device only transmits the telegrams when the delay has elapsed.

After a device reset, the "Dimming" object is always initialised with "0".

Venetian blind function

For each input, whose function is set to "Venetian blind", the ETS indicates the two 1-bit objects "Short time operation" and "Long time operation".

For the control of Venetian blind, roller shutter, awning or similar drives, the device supports two operation concepts for the Venetian blind function in which the telegrams are transmitted in different time sequences. The device can therefore be used to operate a wide variety of drive configurations. In the ETS, the operating concept of an input is defined using the parameter of the same name on the parameter page "Ix - General" (x = 1, 2, 3). The following settings are possible...

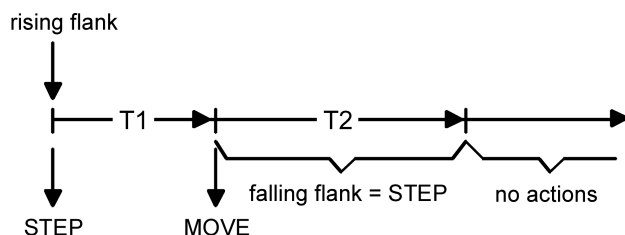

Figure 9: Operation concept "short – long – short"

Operation concept for the Venetian blind function

Operation concept "short – long – short":

In the operation concept "short – long – short", the input shows the following behaviour:

- Immediately after a rising flank (closed pushbutton or switch) the input transmits a short time telegram onto the bus. Pressing the button stops a running drive and starts time T1 ("time between short time and long time operation"). If the a falling flank is detected within T1 (closed pushbutton or switch), no further telegram will be transmitted. This short time serves the purpose of stopping a continuous movement.
The "Time between short time and long time command" in the input parameters should be selected shorter than the short time operation of the actuator to prevent a jerky movement of the shutter.
- If the button is kept depressed longer than T1, the input transmits a long time telegram after the end of T1 for starting up the drive and time T2 ("slat adjusting time") is started.
- If a falling flank is detected within the slat adjustment time, the input transmits an additional short time telegram. This function is used for adjusting the slats of a blind. The function permits stopping the slats in any position during their rotation.
The "slat adjusting time" should be chosen as required by the drive for a complete rotation of the slats. If the "slat adjusting time" is selected longer than the complete running time of the drive, a pushbutton function is possible as well. This means that the drive is active only when a button connected to the input is kept depressed.
- If the button is kept depressed longer than T2, the input transmits no further telegram. The drive remains on until the end position is reached.

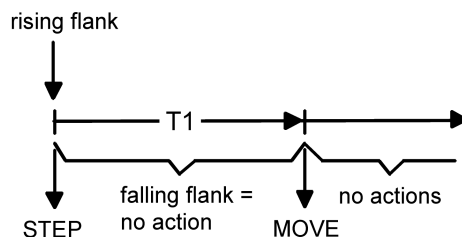

Figure 10: Operation concept "long – short"

Operation concept "long – short":

In the operation concept "long – short", the input shows the following behaviour:

- Immediately on pressing the button, the input transmits a long time telegram. The drive begins to move and time T1 ("slat adjusting time") is started.
- If a falling flank is detected within the slat adjustment time, the input transmits a short time telegram. This function is used for adjusting the slats of a blind. The function permits stopping the slats in any position during their rotation.
The "slat adjusting time" should be chosen as required by the drive for a complete rotation of the slats. If the "slat adjusting time" is selected longer than the complete running time of the drive, a pushbutton function is possible as well. This means that the drive is active only when a button connected to the input is kept depressed.
- If the button is kept depressed longer than T1, the input transmits no further telegram. The drive remains on until the end position is reached.

Flank evaluation

The parameter "Command on rising flank" on the parameter page "Ix - General" (x = 1, 2, 3) specifies the direction of movement of the short time or long time telegram. In the "TOGGLE" setting (single-surface operation) the input switches the direction of the short and long time telegram each time there is a new signal. Several short time telegrams in succession have the same direction.

- i** If the actuator is to be controlled from several locations, a faultless single-surface actuation requires that the all long time objects of the sensor devices are interlinked. A sensor device would otherwise not be able to detect that the actuator has been addressed from another sensor, in which case it would have to be actuated twice during the next use in order to produce the desired reaction.

Response to bus voltage return

After a device reset (bus voltage return or ETS programming operation), the communication object "Long time operation" of the input can be initialised. For this, the "Behaviour on bus voltage return" parameter should be configured to the required reaction. In the settings "Up" or "Down", telegrams are transmitted actively to the bus.

If, in the ETS, a delay is set for the extension inputs after bus voltage return, the device only transmits the telegrams when the delay has elapsed.

After a device reset, the "Short time operation" object is always initialised with "0".

Value transmitter function

For each input whose function is set to "Value encoder", the ETS indicates either a 1-byte or a 2-byte object. The data format of the value object is dependent on the set function of the value encoder. The "Function as" parameter on the parameter page "Ix - General" (x = 1, 2, 3) defines the function on one of the following value encoder applications...

- Dimming value encoder (1-byte),
- Temperature value encoder (2-bytes),
- Brightness value encoder (2-bytes),
- Light scene extension without memory function (1-byte),
- Light scene extension with memory function (1-byte).

The dimming value encoder, temperature and brightness value encoder different in data format and in the range of values. The independent function of the light scene extension is special and is described below.

Dimming value encoder, temperature and brightness value encoder

In the function as a dimming value encoder, the input can transmitted unformatted integers in the range 0 ... 255 to the bus. As a brightness value encoder, the input transmits formatted floating point values in the range 0 ... 1500 Lux and, as a temperature value encoder, in the range 0 ... 40 °C. Table 1 shows a summary of the value ranges of the value encoders. The values to be transmitted are configured in the ETS and can be adjusted later during device operation (see value adjustment below).

The flank evaluation of the device means that it can transmit values only on a rising flank, only on a falling flank or on a rising and falling flank. In this way, it is possible to make adjustments to the contact connected at the input (pushbutton as NC contact or NO contact and switch).

Value encoder type	Function	Lower numerical limit	Upper numerical limit
Dimming value encoder	0 ... 255	0	255
Temperature value transmitter	Temperature value	0 °C	40 °C
Brightness value transmitter	Brightness value	0 lux	1,500 lux

Table 1: Value ranges of dimming value encoder, temperature and brightness value encoder

Value adjustment for dimming value encoder, temperature and brightness value encoder

With the dimming value encoder and the temperature and brightness value encoder, the value to be transmitted can be adjusted at any time during device operation. A value adjustment can only be configurable in the ETS when the value is to be transmitted only on a rising flank or only on a falling flank, i.e. a pushbutton is connected to the input.

A value adjustment is introduced by a long signal at the input (> 5 s) and continues for as long as the signal is detected as active, i.e. the pushbutton is actuated. With the first adjustment after commissioning, the value programmed by the ETS is increased cyclically by the step width configured for the dimming value encoder and transmitted. The step width of the temperature value encoder (1 °C) and the brightness value encoder (50 Lux) is permanently defined. The previously transmitted value is saved after releasing the pushbutton. The next long pushbutton actuation adjusts the saved value and the direction of the value adjustment changes.

The time between two telegrams on adjusting values can be configured in the ETS.

Example of value adjustment (Figure 11):

- Function as dimming value encoder
- Transmit value on = Rising flank
- Value configured in the ETS for rising flank = 17
- Step width = 5

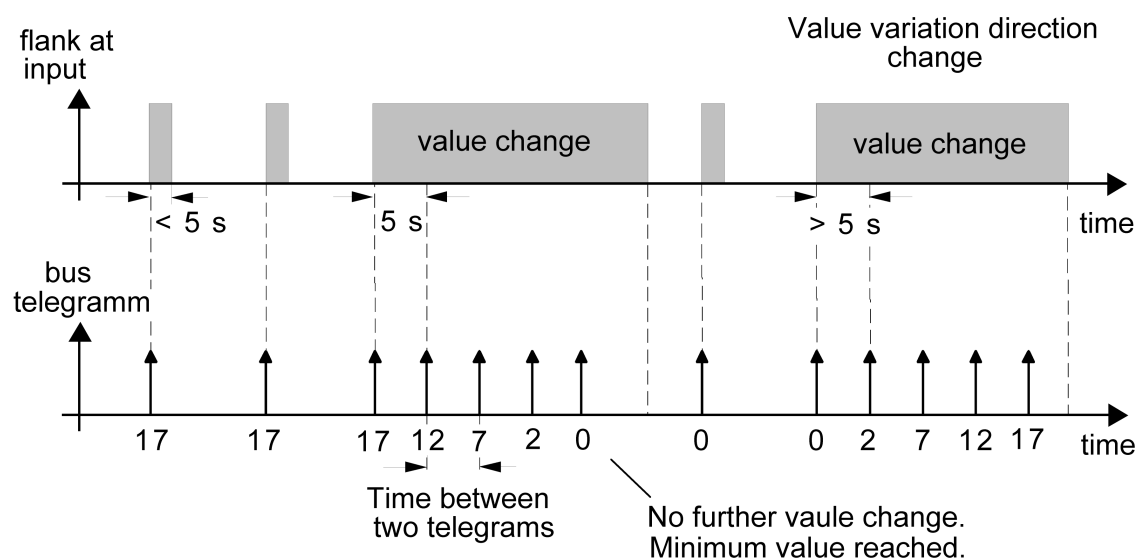

Figure 11: Example to change the value for dimming value encoder

- i** There is no value over- or underrun on adjustment. If, during an adjustment, the maximum or minimum value is reached (see Table 3), no more telegrams are transmitted.
- i** To ensure that, during a value adjustment, for example the controlled lighting switches off or switches on at the maximum, the limit values (e.g. the values "0" or "255") are always transmitted when the limits of the adjustable range are reached. This also takes place when the configured step width of these values is not immediately taken into account (see example above: step width = 5; value "2" is transmitted, then value "0").
In this case, to ensure that the original starting value can be reset on resetting with a change to the adjustment direction, the first value jump is not equal to the preset step width (see example above: step width = 5; value "0" is transmitted, then values "2"; "7" etc.).
- i** The newly adjusted values are stored in RAM. After a device reset (bus voltage failure or ETS programming operation), the adjusted values are replaced by the values originally configured in the ETS.

Light scene extension

With a configuration as a light scene extension without a memory function, it is possible to recall a light scene, which is stored in an external bus subscriber (e.g. light scene pushbutton sensor) With a rising, falling or rising and falling flank, the light scene number configured in the ETS is immediately transmitted to the bus.

With a configuration as a light scene extension with a memory function, it is possible to generate a memory telegram according to the light scene to be transmitted. For this, the appropriate memory telegram is transmitted for a long signal according to the configured flank

evaluation (pushbutton as NC contact or NO contact - not as switch!). In this case, the time for long actuation can be configured (but not to below 5 s). With short actuation < 1 s, the configured light scene number (without memory telegram) is transmitted. If the actuation last longer than 1 s but less than 5 s, no telegram is triggered. In addition, there is the option of only transmitting a memory telegram without prior light scene recall. In this case, the parameter "Only memory function ?" must be set to "Yes".

Examples for a light scene extension with memory function (Figure 12):

- 1.) Only memory function = No
- 2.) Only memory function = Yes

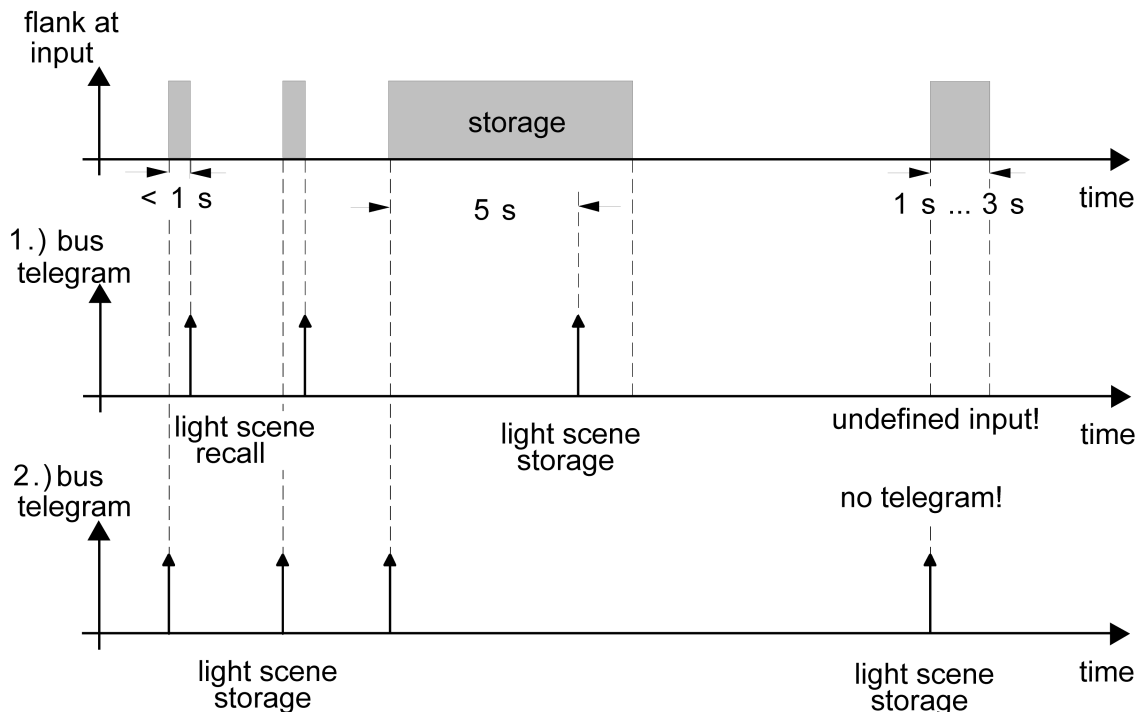

Figure 12: Example of scene storage

"Only memory function = No":

If a rising or falling flank is detected at the input (according to the configuration), the time recording operation begins. If actuation ceases during the first second, the appropriate light scene recall takes place immediately. If the signal length is longer, then the memory telegram is transmitted after 5 s.

"Only memory function = Yes":

The memory telegram is transmitted immediately after detection of the appropriate signal flank.

Behaviour on bus voltage return for value encoder and light scene extension

After a device reset (bus voltage return or ETS programming operation), the communication object of the value encoder or light scene extension can be initialised. For this, the "Behaviour on bus voltage return" parameter should be configured to the required reaction. The setting is dependent on the value encoder function and flank evaluation selected in the ETS. In the settings "Reaction as rising flank" or "Reaction as falling flank", telegrams are transmitted actively to the bus according to the configuration in the ETS. In the "Transmit current input status" setting, the device evaluates the static signal status of the input and, according to this, transmits the appropriately configured telegram to the bus (contact closed at the input = telegram as with rising flank; contact open at input = telegram as with falling flank). This setting can only be configured with "Transmit value on = rising and falling flank (switch)".

If, in the ETS, a delay is set for the extension inputs after bus voltage return, the device only transmits the telegrams when the delay has elapsed.

4.2.4.3.2 Disabling function for extension inputs

The extension inputs can be separately disabled via the bus using 1-bit objects. With the "Switching" function, it is possible to disable the two switching objects of an input independently of each other.

With an active disabling function, signal flanks at the input are ignored by the device related to the affected objects.

Each input or each switching object can execute a specific independent reaction at the beginning or end of a disable. This reaction is specified on the parameter page "Ix - disable" (x = 1, 2, 3) in the ETS and is dependent on the flank evaluation defined for the affected input. In so doing, it is possible to configure to "No reaction". Only in this case are dimming or Venetian blind control operations or value adjustments completed during an active disable and only then the input locked. In all other cases, the configured disabling command is executed immediately at the beginning of disabling.

In the "Transmit current input status" setting, the device evaluates the current static signal status of the input and, according to this, transmits the appropriately configured telegram to the bus (contact closed at the input = telegram as with rising flank; contact open at input = telegram as with falling flank).

A disabling function is activated or deactivated by the corresponding 1-bit object. The telegram polarity can be set in the ETS for each disabling object. The disabling object is always inactive after a device reset. Even with an inverted polarity "Disabling = 0 (Enabling = 1)", a "0" telegram must first be received after a reset until the appropriate disabling function is activated.

- i** Updates to disabling objects with the same telegram polarity (disabling -> disabling or enabling -> enabling) do not show a reaction.
- i** With cyclical transmission in the "Switching" function: during an active disable, cyclical transmission does not take place via the disabled input switching object. Cyclical transmission is continued immediately at the end of the disabling with the last object value written to the object, providing that the transmit criterion for cyclical transmission is fulfilled (transmit on ON, on OFF or on ON and OFF).

4.2.4.4 Channel-oriented functions for the valve output

4.2.4.4.1 General settings

Valve direction of action

Valve drives, which are closed in the deenergised state, and valve drives, which open in the deenergised state, can be connected to the valve output. The direction of action of a deenergised valve drive is determined by the physical structure of the drive and is usually prespecified by the manufacturer of these devices. For the valve drives to be controlled 'with the correction direction of action', the valve direction of action of the connected drives must be configured in the ETS.

Setting the valve direction of action

The valve direction of action can be set on the parameter page "O1 - General".

- Set the "Valve direction of action (valve in deenergised state)" to "closed".

With switching command values, the switching telegram received via the "Command value" object is forwarded directly to the output. This means that, if an "ON" telegram is received, the output is energised and thus the valve completely opened. Switching the output off completely closes the valve when an "OFF" telegram is received (Figure 13).

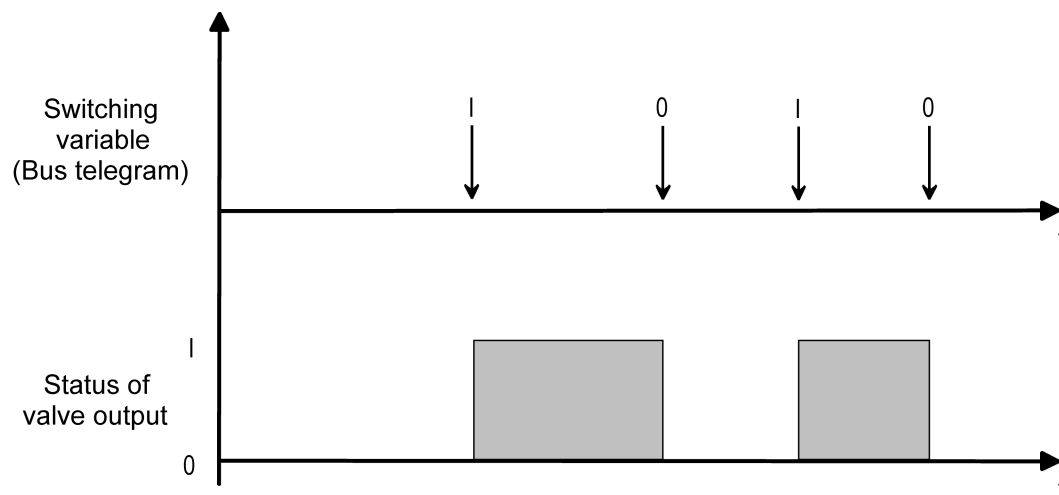

Figure 13: Conversion of a switching command value to an output signal with deenergised, closed valve drives (example)

With constant command values or constant valve setpoint positions (for example, with a forced position or in emergency operation), the valve output is either energised or deenergised cyclically using a pulse width modulation according to the constant valve position to be approached. The scanning ratio of the pulse width modulation is converted in such a way that the switch-on time corresponds directly to the valve target position (Figure 14).

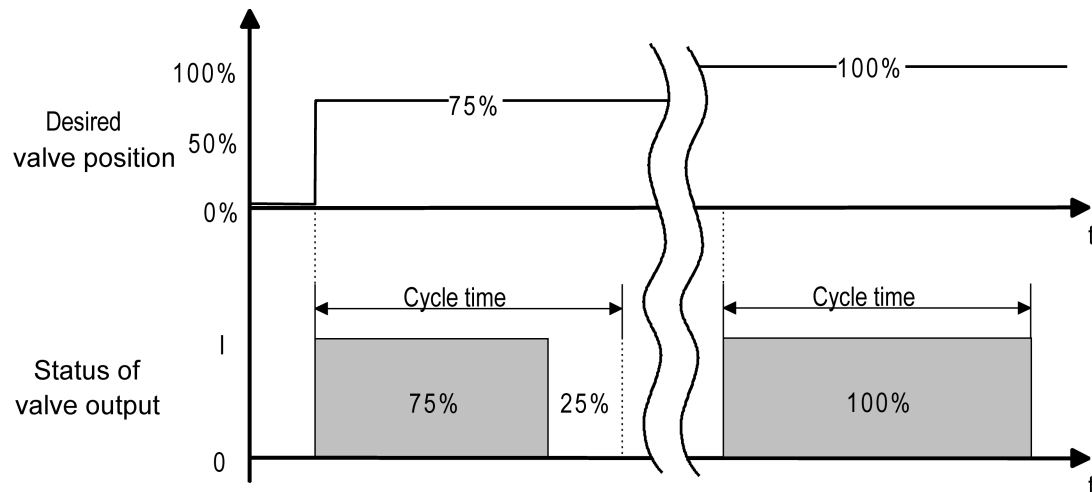

Figure 14: Conversion of a constant valve setpoint position to an output signal with deenergised, closed valve drives (example)

- Set the "Valve direction of action (valve in deenergised state)" to "open".
 With switching command values, the switching telegram received via the "Command value" object is forwarded directly to the output. This means that, if an "ON" telegram is received, the output is deenergised and thus the valve completely opened. Switching the output on completely closes the valve when an "OFF" telegram is received (Figure 15).

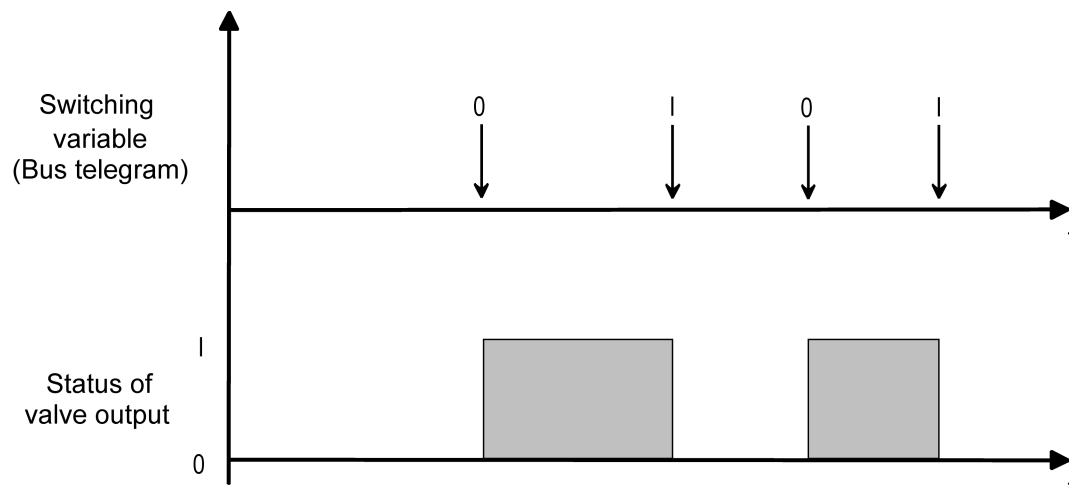

Figure 15: Conversion of a switching command value to an output signal with deenergised, opened valve drives (example)

With constant command values or constant valve setpoint positions (for example, with a forced position or in emergency operation), the valve output is either energised or deenergised cyclically using a pulse width modulation according to the constant valve position to be approached. The scanning ratio of the pulse width modulation is converted in such a way that the switch-off time corresponds directly to the valve target position (Figure 16).

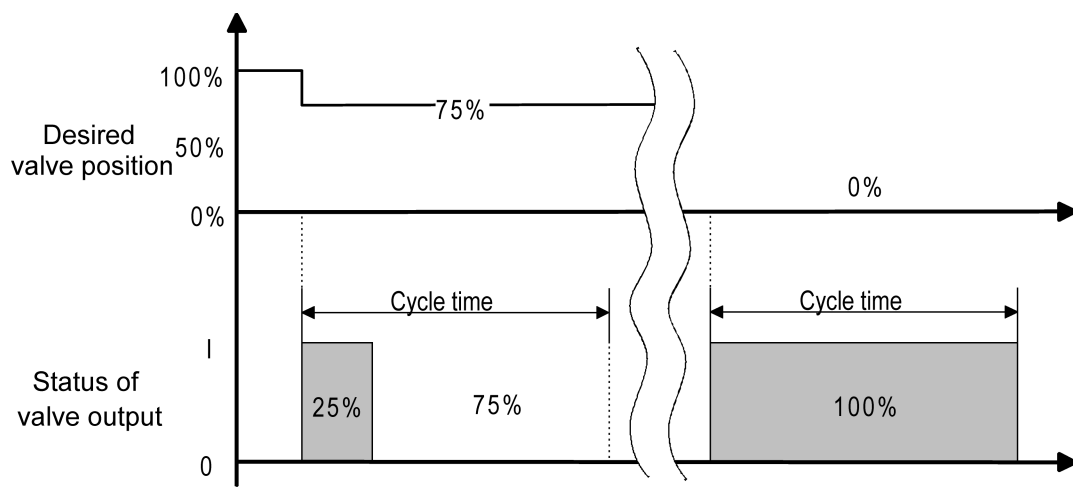

Figure 16: Conversion of a constant valve setpoint position to an output signal with deenergised, opened valve drives (example)

- i** Depending on the conversion of the PWM switch-on time to the valve setpoint position, there is no unintentional average value shift for the different valve types.

Example:

Command value: 60 % ->

Scanning ratio, deenergised closed: 60 % On, 40 % Off,

Scanning ratio, deenergised opened: 40 % On, 60 % Off,

- i** If there is a mains voltage failure or a short-circuit at the valve output, the connected valve drives are no longer controlled electrically, meaning that the drives switch to the deenergised status preset by the manufacturer (deenergised opened / deenergised closed).
With the device status messages ("Command value status", "Valve closed"), a valve completely opened by a mains voltage failure or short-circuit (valve direction of action deenergised open) is evaluated as a closed valve, as the valve status was caused by a fault.

Forced position function

The valve can be idle in various operating states, which it may be possible to activate using separate communication objects. One of these object-controlled operating states is the forced position.

With the forced position of the valve output, a constant valve forced position (0 % to 100 %) can be stored in the device, which is applied as the valve setpoint in an activated forced position and which is executed by a pulse width modulation. The valve forced position can be set in the ETS differently for summer and winter operation, if the operating mode switchover is enabled.

- i** With an active forced position, the configured pulse width modulation is also executed when the output is configured to a switching 1-bit command value.

Enabling the forced position function

The forced position function can be activated on the parameter page "O1 - General".

- Set the parameter "Forced position through object to "Enabled". Configure the parameter "Value for forced position (0...100%)" to the required valve forced position. The "Value for forced position..." parameter may be visible twice if the operating mode switchover is enabled. In this case, it is possible to specify different valve forced positions for summer and winter operation in the ETS.

The forced position function is enabled and the 1-bit communication object "Forced position" is visible in the ETS. As soon as an "ON" telegram was received, the device activates the forced position for the valve output and controls the valve drive to the specified valve forced position value. The valve output can then no longer be controlled using command values from the bus.

If the device receives an "OFF" telegram via the forced object, it deactivates the forced position and reenables bus control using the command values. The command most recently received before or during the forced position and stored in the device is applied as the new command value setpoint at the end of the forced position.

- Set the parameter "Forced position through object to "Disabled".
The forced position function is deactivated, meaning that the appropriate object is not visible in the ETS.
However, the parameters "Value for forced position" or "Value for summer forced position" or "Value for winter forced position" are visible and settable in the ETS because, on bus voltage failure and after a bus voltage return or after an ETS programming operation, the forced value can be applied as a command value setpoint and thus a configurable value must be available in the ETS.
- i** The forced position has a higher priority than the command value limit. This means that, in the case of a forced position, the command value setpoint configured in the ETS is always set at the valve output and is not limited by the command value limit. However, at the end of a forced position the command value limit is again taken into account, if it is active at this time. In this case, the added command value is limited at the end of the forced position.
- i** The operating mode (summer / winter) can also be switched over using the object during an activated forced position. In this case, the device adjusts the pulse width modulation to the valve position value of the valid operating mode immediately after the switchover.
- i** Updates of the forced object from "ON" to "ON" or "OFF" to "OFF" do not produce a reaction.
- i** Behaviour of the forced position function after a bus voltage return: If there is a bus voltage failure, the state of the "Forced position" object is saved in the non-volatile memory of the device.
A forced position function activated using the forced position object before the bus voltage failure can then be activated after bus voltage return and continue to be executed if the "Behaviour after bus voltage return" of the valve output is configured to "State as before bus failure". Otherwise, the forced position is always deactivated after bus voltage return. After bus voltage return, the operating mode (summer / winter) is initialised according to the parameter "Operation mode after device reset".
The forced position function is always deactivated after an ETS programming operation.
- i** The anti-sticking protection has a higher priority than a forced position, meaning that the anti-sticking protection overrides forced operation. By contrast, the forced position has a higher priority than emergency operation or operation through command value telegrams.

Operating switchover, summer / winter operation

Constant valve position values (0...100%) can be configured in the ETS for the forced position function and emergency operation. If a forced position or emergency operation was activated, the device switches the specified valve position at the valve output using pulse width modulation.

It is possible to specify different valve position values for summer and winter in the ETS for the named functions. For example, emergency operation activated during a fault as part of command value monitoring can cause a different valve opening than winter operation. In addition, a different valve position can be specified according to the season for a forced position.

Enabling operating mode switchovers

For the device to be able to distinguish between the summer and winter valve position values for the forced position function and emergency operation, the operating mode switchover must be enabled in the ETS.

- Set the "Summer/winter mode switchover ?" parameter on the parameter page "O1 - General" to "Yes".

The operating mode switchover for summer and winter operation is enabled. The 1-bit communication object "Summer/winter switchover" becomes visible in the ETS. The operating mode can be switched over by a bus telegram at any time using this object. In addition, the ETS automatically makes additional parameters visible, meaning that separate valve position values can be configured for summer and winter for the forced position function and emergency operation.

- Set the "Summer/winter mode switchover ?" parameter on the parameter page "O1 - General" to "No".

The operating mode switchover for summer and winter operation is disabled. Only one valve position value can be configured separately for the forced position function and emergency operation in the ETS. No distinction is made between summer and winter operation.

- i** The summer / winter operating mode switchover is deactivated in the as-delivered state. The device then only works with one valve position value for the forced position and emergency operation.

Setting the telegram polarity for the operating mode switchover

The telegram polarity of the 1-bit "Summer/winter switchover" communication object can be set in the ETS.

The operating mode switchover must have been enabled in advance.

- Set the "Polarity, summer/winter switchover object" on the parameter page "O1 - General" to "Summer = 0 / Winter = 1".

Summer operation is activated by an "OFF" telegram and winter operation by an "ON" telegram.

- Set the "Polarity, summer/winter switchover object" on the parameter page "O1 - General" to "Summer = 1 / Winter = 0".

Summer operation is activated by an "ON" telegram and winter operation by an "OFF" telegram.

- i** The object state after a device reset (ETS programming operation, bus voltage return) can be set separately in the ETS (see "Setting the operating mode after a device reset").

- i** The operating mode can also be switched over using the object during activated emergency operation or an activated forced position. In this case, the device adjusts the pulse width modulation to the valve position value of the valid operating mode immediately after the switchover.

In addition, the value for emergency operation and the value for the forced position can be applied as a valve position value after an ETS programming operation or a bus voltage return and pulse width modulation started. The device only uses the valve position values (0...100 %) configured in the ETS, taking the set or added operation mode into account. The forced position function or emergency operation are not activated, meaning that the switchover of the operation mode after one of the named events does not lead to a switchover of the summer/winter valve position.

Setting the operating mode after device reset

After an ETS programming operation or bus voltage return, the device automatically initialises the value of the communication object "Summer/winter switchover". The initialisation value is configured in the ETS.

The operating mode switchover must have been enabled in advance.

- Set the parameter "Operating mode after ETS programming operation" on the parameter page "O1 - General" to "Summer operation".
Summer operation is initialised immediately after bus voltage return or ETS programming.
- Set the parameter "Operating mode after ETS programming operation" on the parameter page "O1 - General" to "Winter operation".
Winter operation is initialised immediately after bus voltage return or ETS programming.
- ❗ The operating mode set after a device reset is also added to the object "Summer/winter switchover", taking the configured telegram polarity into account, and can be read out (set the "R" flag).

Anti-sticking protection

The device possesses automatic anti-sticking protection, in order to prevent calcification or sticking of a valve which has not been operated for some time.

Enabling anti-sticking protection

Anti-sticking protection is enabled on parameter page "O1 - General".

- Set the parameter "Anti-sticking protection" to "enabled".
Anti-sticking protection is activated cyclically every 6 days, irrespective of the current operating state and the active valve position. In so doing, the device switches the valve output on for approx. 5 minutes. After this switch-on phase, the device switches the valve output off for approx. 5 minutes. This ensures that the valves are opened and closes almost completely, meaning that the entire valve movement path is 'travelled' once. After the anti-sticking protection, the device again controls the output according to the set operating state.
- Set the parameter "Anti-sticking protection" to "disabled".
The anti-sticking protection is completely deactivated and is not executed.
- ❗ Irrespective of the bus voltage, anti-sticking protection always runs 'in the background' and is not signalled to the bus using the status objects.
- ❗ The cycle time of the anti-sticking protection is only restarted after the bus voltage has been switched on again on the device or the device was reprogrammed using the ETS. In these cases, at least approx. 6 days must elapse until the anti-sticking protection is automatically executed for the first time.
- ❗ The anti-sticking protection has a higher priority than a forced position or emergency operation. These operating states are overridden by the anti-sticking protection, as normal operation is by command values.

Reset and initialisation behaviour

The state of the valve output after bus voltage return or after an ETS programming operation can be set in the ETS.

Behaviour in case of bus voltage failure

The device is supplied solely via the bus voltage. If the bus voltage fails or is switched off, the device does not work either, meaning that the valve output is no longer controlled electrically. As a result, the drives switch over to the deenergised state specified by the manufacturer.

- i** If the bus voltage fails, the states of the last command value/valve setpoint position and the "Forced position" object are stored in the non-volatile memory of the device. Storage takes place so that the states can be restored on bus voltage return, if this is configured for bus voltage return.
The data is only stored if the bus voltage has been available before without interruption for at least 20 seconds after the last reset (storage capacitors sufficiently charged for storage purposes). In all other cases nothing is stored.

Setting the behaviour on bus voltage return

The parameter "Behaviour after bus voltage return" can be preset on parameter page "O1 - General". The parameter defines the behaviour as soon as the the bus supply voltage is switched on.

- Set the parameter to "Close valve".
After bus voltage return, the device closes the connected valve drives completely. In so doing, the valve direction of action configured in the ETS is taken into account so that the output is switched off for deenergised closed valves and the output is energised for deenergised opened valves.
 - Set the parameter to "Open valve".
After bus voltage return, the device opens the connected valve drives completely. In so doing, the valve direction of action configured in the ETS is taken into account so that the output is switched off for deenergised closed valves and the output is energised for deenergised opened valves.
 - Set the parameter to "Valve to value for forced position".
The device sets the valve drive to the value for the forced position (0...100 %) configured in the ETS. In the 0 % setting, the output is closed completely, whilst, in the 100 % setting it is completely opened. The energisation of the valve output always takes place taking the set valve direction of action into account. The forced position value is executed as pulse width modulation (PWM) even in the case that the output is configured to a switching command value (1 bit).
In the settings 1...99 % for the forced position value, the device carries out PWM at the valve output after bus voltage return until a new valve state is specified.
 - Set the parameter to "Valve to value for emergency operation".
The device sets the valve drive to the value for emergency operation (0...100 %) configured in the ETS. In the 0 % setting, the output is closed completely, whilst, in the 100 % setting it is completely opened. The energisation of the valve output always takes place taking the set valve direction of action into account. The forced position value is executed as pulse width modulation (PWM) even in the case that the output is configured to a switching command value (1 bit).
In the settings 1...99 % for the emergency operation value, the device carries out PWM at the valve output after bus voltage return until a new valve state is specified.
 - Set the parameter to "State as before bus failure".
After bus voltage return, the state last selected and internally stored before bus voltage failure (last command value/valve setpoint position and state of the "Forced position" object) will be tracked. If the last command value before the bus failure was limited by the command value limit, then the limited value is added as the last active value after bus voltage return.
- i** The device only executes the configured "Behaviour after bus voltage return" only if the last ETS programming of the application or of the parameters ended at least approx. 20 s prior to switching on the bus voltage. Otherwise ($T_{ETS} < 20$ s), the "Behaviour after ETS programming" will be adopted also in case of bus voltage return.

- i** The following should be observed for the settings "Valve to value for forced position" and "Valve to value for emergency operation":
The device only uses the valve position values (0...100 %) configured in the ETS. The forced position function or emergency operation are not activated. However, it should be noted that the value for the forced position has a higher priority than a command value limit. Thus, a forced position value set for after bus voltage return is not limited by the command value limit. However, a value for emergency operation can be limited.
The values for forced position and emergency operation are also dependent on the summer / winter operation of the device. If the operating mode switchover is activated for the valve outputs (see page 34), two separate valve position values for summer operation and winter operation are configured and distinguished between in the ETS.
After bus voltage return, the device reinitialises and uses the operating mode configured in the ETS according to the parameter "Operation mode after device reset".
- i** In the setting "State before bus failure": An ETS programming operation of the application or the parameter deletes the internally stored states.
- i** A valve state set after bus voltage return is added to the status object.
- i** The cycle times of the anti-sticking protection and the command value monitoring are restarted after the bus supply voltage is switched on again.
- i** The valve state configured in the ETS is set after bus voltage return. In so doing, the status message "Valve closed" is updated according to the current status and a telegram sent to the bus, providing the status message is enabled.
However, transmission of the status telegram shall only take place after the delay time after bus voltage return configured in the ETS has elapsed.
- i** Optionally, the command value limit for 1-byte command values can be active after bus voltage return (see page 50). In this case, it should be noted that the reactions specified after bus voltage return are influenced and thus limited by the command value limit (exception: "Valve to forced position value").
- i** After bus voltage return, the device retracts a short-circuit message transmitted before bus voltage failure by transmitting an alarm telegram appropriate to the polarity set in the ETS (see page 54).

Presetting the behaviour after ETS programming

The parameter "Behaviour after ETS programming operation" can be preset on the parameter page "O1 - General". This parameter can be used to configure the behaviour of the valve output, irrespective of the behaviour after bus voltage return.

- Set the parameter to "Close valve".
After an ETS programming operation, the device closes the connected valve drives completely. In so doing, the valve direction of action configured in the ETS is taken into account so that the output is switched off for deenergised closed valves and the output is energised for deenergised opened valves.
- Set the parameter to "Open valve".
After an ETS programming operation, the device opens the connected valve drives completely. In so doing, the valve direction of action configured in the ETS is taken into account so that the output is switched off for deenergised closed valves and the output is energised for deenergised opened valves.
- Set the parameter to "Valves to value for forced position".
The device sets the connected valve drives to the value for the forced position (0...100 %) configured in the ETS. In the 0 % setting, the output is closed completely, whilst, in the 100 % setting it is completely opened. The energisation of the valve output always takes place taking the set valve direction of action into account.
In the settings 1...99 % for the forced position value, the device carries out PWM at the valve output after an ETS programming operation until a new command value or another function is specified or activated. In this case, the PWM is also executed after an ETS programming operation, should the output be configured to a switching command value (1-bit).
- Set the parameter to "Valves to value for emergency operation".

The device sets the connected valve drives to the value for emergency operation (0...100 %) configured in the ETS. In the 0 % setting, the output is closed completely, whilst, in the 100 % setting it is completely opened. The energisation of the valve output always takes place taking the set valve direction of action into account.

In the settings 1...99 % for the emergency operation value, the device carries out PWM at the valve output after an ETS programming operation until a new command value or another function is specified or activated. In this case, the PWM is also executed after an ETS programming operation, should the output be configured to a switching command value (1-bit).

- i** The following should be observed for the settings "Valve to value for forced position" and "Valve to value for emergency operation":
The device only uses the valve position values (0...100 %) configured in the ETS. The forced position function or emergency operation are not activated. However, it should be noted that the value for the forced position has a higher priority than a command value limit. Thus, a forced position value set for after an ETS programming operation is not limited by the command value limit. However, a value for emergency operation can be limited.
The values for forced position and emergency operation are also dependent on the summer / winter operation of the device. If the operating mode switchover is activated for the valve outputs (see page 34), two separate valve position values for summer operation and winter operation are configured and distinguished between in the ETS.
- i** The configured behaviour will be executed after every application or parameter download by the ETS. A simple download of the physical address alone or partial programming of only the group addresses has the effect that this parameter is disregarded and that the configured "Behaviour after bus voltage return" will be executed instead.
- i** Optionally, the command value limit for 1-byte command values can be active after an ETS programming operation (see page 50). In this case, it should be noted that the reactions specified after an ETS programming operation are influenced and thus limited by the command value limit (exception: "Valve to forced position value").
- i** The valve state configured in the ETS is set after an ETS programming operation. In so doing, the status message "Valve closed" is updated by the device according to the current status and a telegram sent to the bus, providing the status message is enabled. However, transmission of the status telegram shall only take place after the delay time after bus voltage return configured in the ETS has elapsed.
- i** A valve state set after an ETS programming operation is added to the feedback object.

4.2.4.4.2 Command value settings

Command value evaluation

The valve output can be controlled via switching with a 1-bit command value telegram or alternatively constantly with a 1-byte command value telegram. Constant command values are converted via pulse width modulation at the output. The cycle time of the output signal is generally configurable in this case.

Command value telegrams are usually transmitted to the device via the bus by a KNX/EIB room temperature controller. In so doing, the room temperature controller generates the command value telegrams using a control algorithm. It should be noted that the heating actuator does not carry out temperature control itself.

Configuring the command value type (1-bit / 1-byte)

The type of command value can be set. This configuration is possible on parameter page "O1 - Command value".

- Set the "Type of command value" parameter to "Switching (1-bit)".

In normal operation, the switching telegram received via the 1-bit "Command value" object, is directly forwarded to the valve output of the device, taking the valve direction of action (deenergised open / deenergised closed) into account (Figure 17). This means that, if an "ON" telegram is received, the valve is completely opened (output energised on valve direction of action = closed / output deenergised on valve direction of action = opened).

If an "OFF" telegram is received, the valve is completely closed (output deenergised on valve direction of action = closed / output energised on valve direction of action = opened).

In a forced position, emergency operation, after an ETS programming operation and on bus voltage return, a constant valve setpoint position value (0...100%) can be configured and activated in the ETS, even with a 1-bit command value. In this case, the setpoint is set by pulse width modulation on the valve output, taking the "Cycle time (PWM of the valve output" into account (see "Pulse width modulation for constant command values and constant setpoint valve positions").

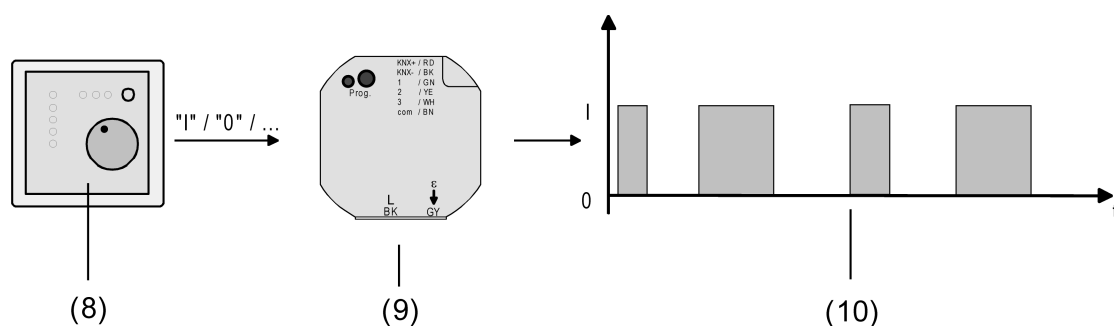

Figure 17: Command value principle for switching command value

- (8) Room temperature controller (command value "1-bit")
- (9) Heating actuator
- (10) Switching output signal for valve drives

- Set the "Type of command value" parameter to "Continuous (1-byte)".

In normal operation, the value telegram received via the 1-byte "Command value" object is converted by the device into an equivalent pulse width modulated switching signal at the valve outputs (Figure 18). Taking the cycle time (T) settable in the device into account, the average output signal resulting from this modulation is a measure of the centred valve position of the control valve and thus a reference for the set room temperature (see "Pulse width modulation for constant command values and constant valve setpoint positions").

A shift of the mean value, and thus a change in the heating or cooling capacity, can be obtained by changing the duty factor of the switch-on and switch-off pulses of the output signal. The scanning ratio is continually adjusted by the device according to the received command value (normal operation) or the valve setpoint position (forced position, emergency operation, after ETS programming operation, on bus voltage return).

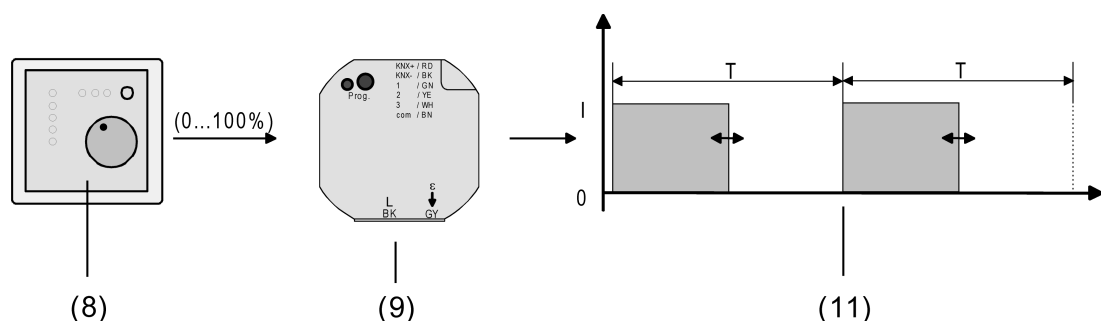

Figure 18: Command value principle for constant command value

- (8) Room temperature controller (command value "1-byte")
- (9) Heating actuator
- (11) Pulse width modulated output signal for valve drives

Pulse width modulation for constant command values and constant valve setpoint positions

Function of a pulse width modulation:

As soon as that device should set a constant command value or a valve setpoint position value configured in the ETS, it modulates the output signal using the switch-on pulse width. Taking the cycle time (T) settable in the device into account, the average output signal (M) resulting from this modulation is a measure of the centred valve position of the control valve and thus a reference for the set room temperature (Figure 19).

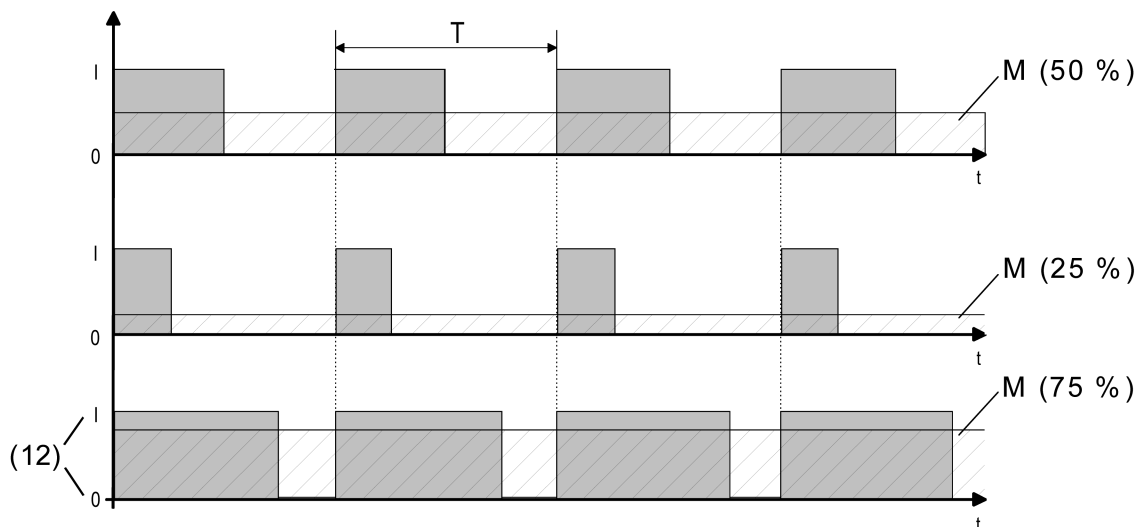

Figure 19: Pulse width modulation of a valve output signal

(12) Valve state (0 = Valve closed / 1 = Valve opened)

A shift of the mean value, and thus a change in the heating or cooling capacity, can be obtained by changing the duty factor of the switch-on and switch-off pulses of the output signal. The scanning ratio is continually adjusted by the device according to the received command value (normal operation) or the valve setpoint position (forced position, emergency operation, after ETS programming operation, on bus voltage return).

Adjusting the pulse width modulation:

Often, control circuits are subject to changes in the setpoint specification (e.g. frost protection, night operation, etc.) or short time interference (e.g. measured value deviations due to brief opening of windows or doors near the sensor). For the setting of the scanning ratio of the required command value to take place as quickly and correctly in these cases, even with longer cycle times (typically 10...20 minutes), without any negative impact on the reaction time of the control section, the device uses a special and very effective method for continuous command value adjustment.

A distinction is made between the following cases...

Case 1:

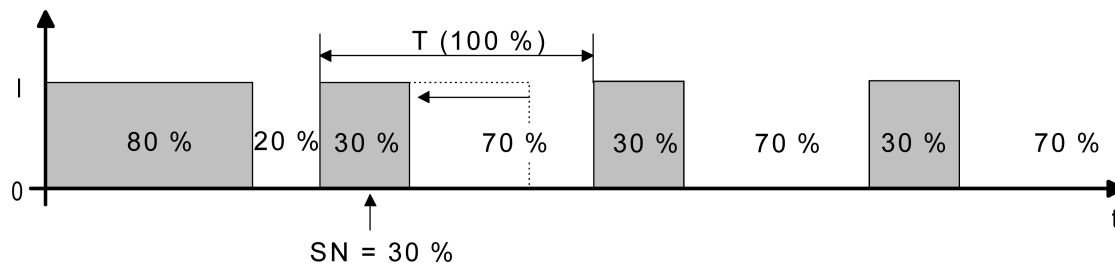

Figure 20: Command value change, e.g. from 80 % to 30 % during the opening phase of the valve

Before specifying a new valve setpoint position value (SN = 30 %), the old setpoint (80 %) was active. The new setpoint is specified during the open phase of the valve. At this point, the device detects that it is still possible to shorten the opening phase, so that it corresponds to the

new valve position (30 %). The cycle time (T) is not affected by this operation.

The new scanning ration is set immediately after receipt of the new valve setpoint position value.

Case 2:

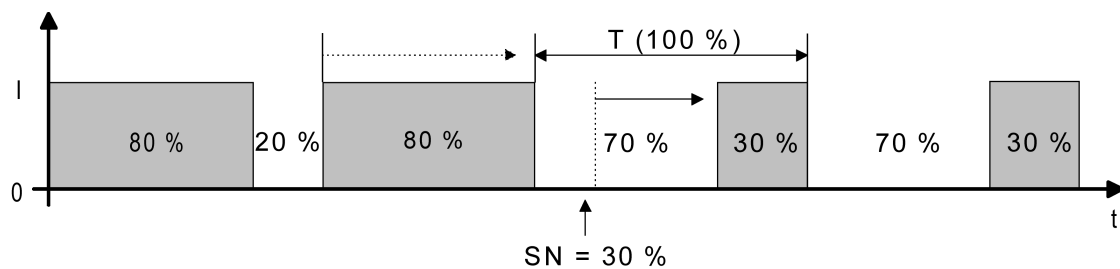

Figure 21: Command value change, e.g. from 80 % to 30 % during the closing phase of the valve

Before specifying a new valve setpoint position value (SN = 30 %), the old setpoint (80 %) was active. The new setpoint is specified during the closing phase of the valve. At this point, the device detects that it is still possible to extend the closing phase, so that it corresponds to the new valve position (30 %). The cycle time (T) remains unchanged, but the starting time of the period is shifted automatically.

The new scanning ration is set immediately after receipt of the new valve setpoint position value.

Case 3:

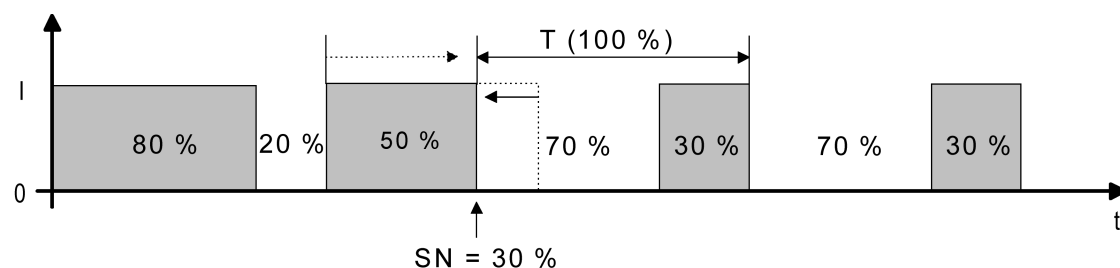

Figure 22: Command value change, e.g. from 80 % to 30 % during the opening phase of the valve (opening phase too long)

Before specifying a new valve setpoint position value (SN = 30 %), the old setpoint (80 %) was active. The new setpoint is specified during the open phase of the valve. At this point, the device detects that it is necessary to cancel the opening phase and close the valve, so that the scanning ratio corresponds to the new valve position (30 %). The cycle time (T) remains unchanged, but the starting time of the period is shifted automatically.

The new scanning ration is set immediately after receipt of the new valve setpoint position value.

Case 4:

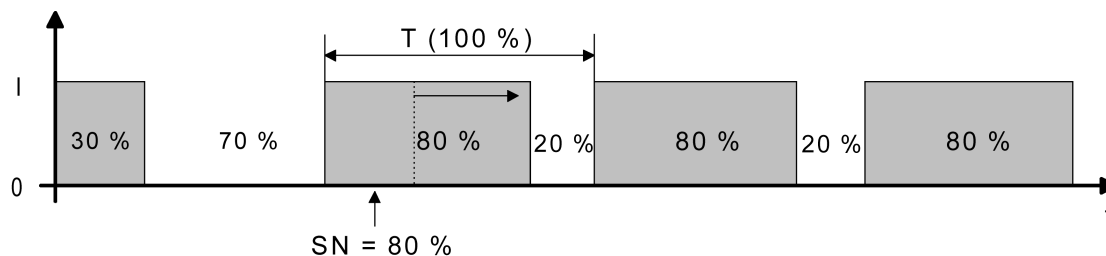

Figure 23: Command value change, e.g. from 30 % to 80 % during the opening phase of the valve

Before specifying a new valve setpoint position value (SN = 80 %), the old setpoint (30 %) was active. The new setpoint is specified during the open phase of the valve. At this point, the device detects that it is still possible to extend the open phase, so that it corresponds to the new valve position (80 %). The cycle time (T) is not affected by this operation.

The new scanning ration is set immediately after receipt of the new valve setpoint position value.

Case 5:

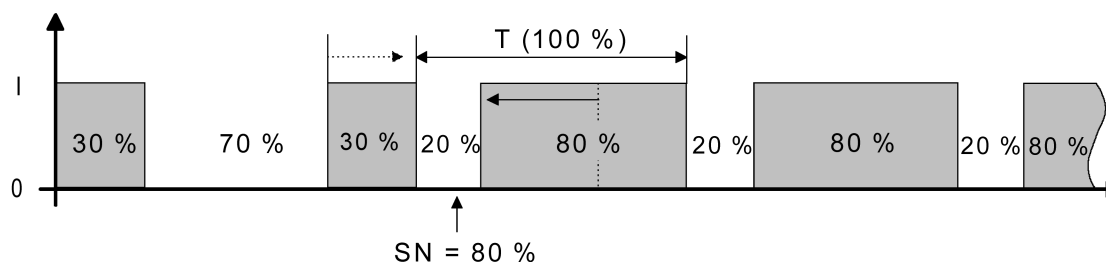

Figure 24: Command value change, e.g. from 30 % to 80 % during the closing phase of the valve

Before specifying a new valve setpoint position value (SN = 80 %), the old setpoint (30 %) was active. The new setpoint is specified during the closing phase of the valve. At this point, the device detects that it is still possible to reduce the closing phase, so that it corresponds to the new valve position (80 %). The cycle time (T) remains unchanged, but the starting time of the period is shifted automatically.

The new scanning ration is set immediately after receipt of the new valve setpoint position value.

Case 6:

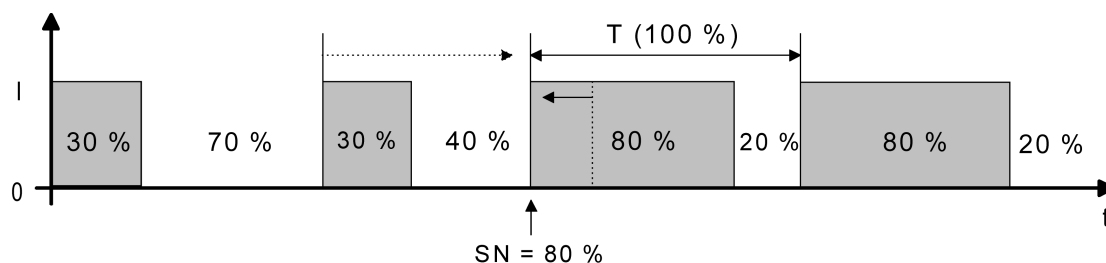

Figure 25: Command value change, e.g. from 30 % to 80 % during the closing phase of the valve (closing phase too long)

Before specifying a new valve setpoint position value (SN = 80 %), the old setpoint (30 %) was active. The new setpoint is specified during the closing phase of the valve. At this point, the device detects that it is necessary to cancel the closing phase and open the valve, so that the scanning ratio corresponds to the new valve position (80 %). The cycle time (T) remains unchanged, but the starting time of the period is shifted automatically.

The new scanning ration is set immediately after receipt of the new valve setpoint position value.

Cycle time of the pulse width modulation:

The cycle time specifies the switching frequency of a pulse width modulated output signal. The variable adjustment option of the cycle time in the ETS allows adaptation to the adjusting cycle times (the adjusting time it takes the drive to bring the valve from its completely closed to its completely opened position) of the actuators used. In this setting, take account of the dead times of the valve drives (the time in which the actuators do not show any response when being switched on or off). If different actuators with different adjusting cycle times are used, take account of the longest of the times.

The cycle time specified on parameter page "O1 - Times".

- i It may be necessary, depending on the drives used, to energise these for a longer period of time on first commissioning for the drives to be ready for operation (observe the information of the drive manufacturer).

During cycle time configuration, a distinction can always be made between two cases...

Case 1: Cycle time > 2 x adjusting cycle time of the electrothermal drives used (ETA)

In this case, the switch-on or switch-off times of the valve output are long enough for the actuators to have sufficient time to fully open or fully close within a given period.

Advantages:

The desired mean value for the command value and thus for the required room temperature will be set relatively precisely, even for several actuators triggered at the same time.

Disadvantages:

It should be noted, that, due to the full valve lift to be continuously 'swept', the life expectancy of the actuators can diminish. For very long cycle times (> 15 minutes) with less sluggishness in the system, the heat emission into the room, for example, in the vicinity of the radiators, can possibly be non-uniform and be found disturbing.

- i This setting is recommended for sluggish heating systems (such as underfloor heating).
- i Even for a bigger number of triggered actuators, maybe of different types, this setting can be recommended to be able to obtain a better mean value of the adjusting travels of the valves.

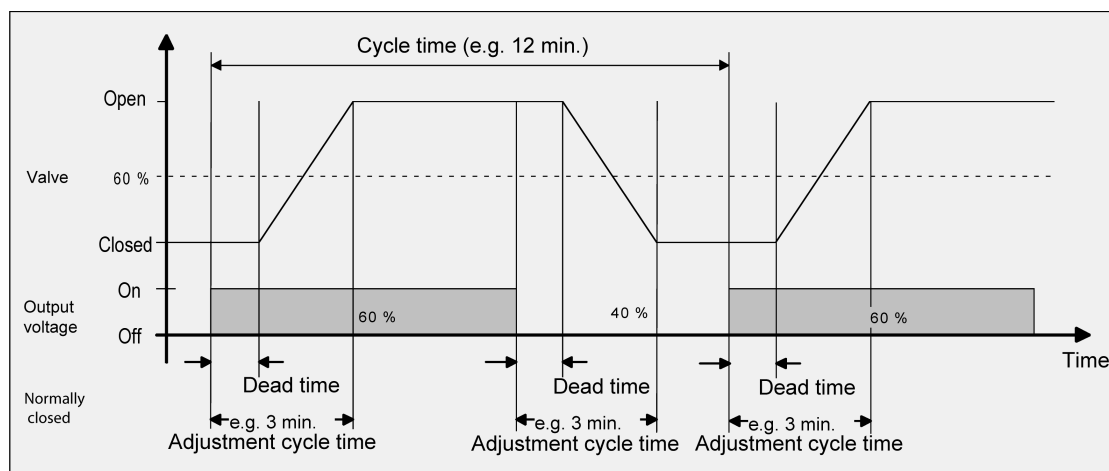

Figure 26: Ideal course of the valve stroke for a command value of approx. 60 % of a deenergised, closed valve

Case 2: Cycle time < adjusting cycle time of the electrothermal drives used (ETA)

In this case, the switch-on or switch-off times of the valve output are too short for the actuators to have enough time to fully open or fully close within a given period.

Advantages:

This setting ensures continuous water flow through the radiators, thus facilitating uniform heat emission into the room.

If only one actuator is triggered the regulator can continuously adapt the command value to compensate the mean value shift caused by the short cycle time, thus setting the desired room temperature.

Disadvantages:

If more than one drive is triggered at the same time the desired mean value will become the command value, which will result in a very poor adjustment of the required room temperature, or in adjustment of the latter with major deviations, respectively.

i This setting is recommended for 'quicker' heating systems (such as surface radiators).

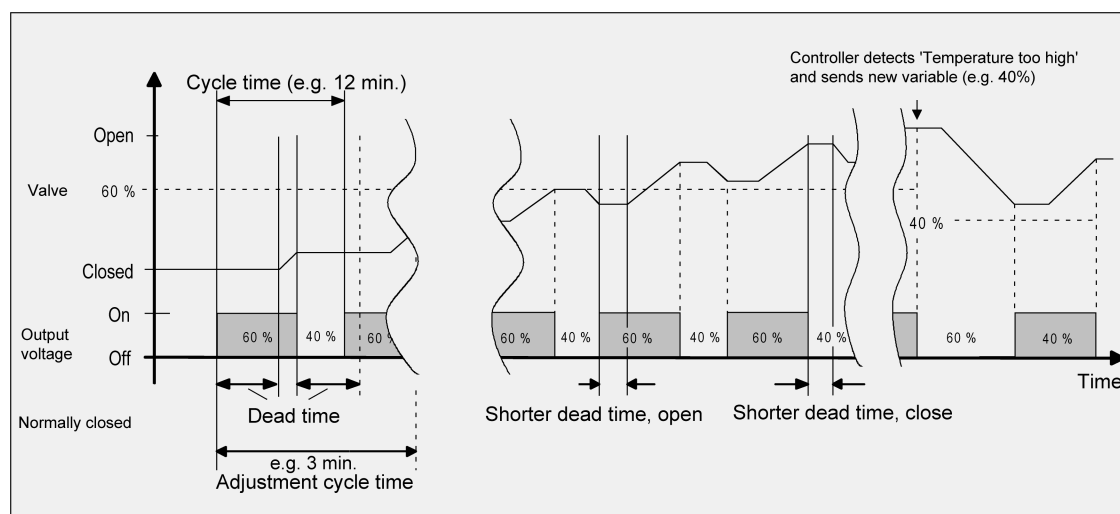

Figure 27: Ideal course of the valve stroke for a command value of approx. 60 % at first of a deenergised, closed valve

The continuous flow of water through the valve, and thus the continuous heating of the drives causes changes to the dead times of the drives during the opening and closing phase. The short cycle time and the dead times means that the required variable (mean value) is only set with a possibly large deviation. For the room temperature to be regulated constantly after a set time, the controller must continually adjust the command value to compensate for the mean value shift caused by the short cycle time. Usually, the control algorithm implemented in the controller (PI control) ensures that control deviations are compensated.

Cyclical command value monitoring

The device offers the option of monitoring the command value of the valve output. This monitoring checks whether command value telegrams have been received by the device within a time interval that can be defined in the ETS. If there are no telegrams during the monitoring time, the device activates emergency operation and adjusts the connected valve drives to an emergency operation valve position configured in the ETS. As a rule, a room thermostat transmits its command values cyclically to the bus if cyclical monitoring has been activated in the device (Figure 28).

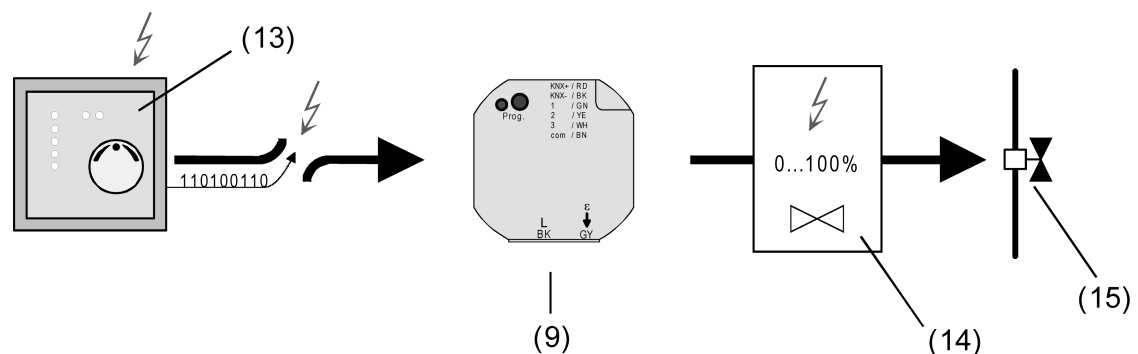

Figure 28: Principle of cyclical command value monitoring in the event of a fault (e.g. open circuit)

- (9) Heating actuator
- (13) Faulty room thermostat with cyclical telegram transmission of the command values
- (14) Valve setpoint position value for emergency operation
- (15) Valve drive

In the device, the monitoring time can be configured to between 1 minute and 59 minutes, whereby the device automatically adds a safety window of 30 seconds to the configured time.

During the monitoring time the device expects at least one command value telegram. If a telegram is received, then the device resets the monitoring time for the valve output and restarts the time interval.

The cyclical monitoring begins immediately after commissioning via the ETS, or after the bus voltage is switched on.

When the bus voltage is switched on, if no telegram is received by the time the monitoring time has elapsed, the valve output immediately assumes the emergency operation valve state as configured in the ETS. In so doing, the device can also transmit a 1-bit alarm message to the bus via the object "Alarm monitoring command value" provided that the alarm object in the ETS is connected to a group address. The telegram polarity of this alarm message can be configured in the ETS.

In the ETS, the valve state for emergency operation is stored as the constant valve emergency position (0 %... 100 %), which is applied as the valve setpoint position in activated emergency operation and which is executed by a pulse width modulation. The valve emergency position

can be set in the ETS differently for summer and winter operation, if the operating mode switchover is enabled.

- i** With active emergency operation, the configured pulse width modulation is also executed when the valve output is configured to a switching 1-bit command value.

Only when a new command value telegram is received does the device reset the monitoring time, reset it, and resets the valve output in accordance with the command value specification. Emergency operation is then terminated automatically. The alarm message is also retracted here by having the device transmit an inverted alarm telegram to the bus.

Enable cyclical command value monitoring

Cyclical command value monitoring can be enabled on the parameter page "O1 - Command value".

- Set the "Cyclical monitoring of the command value" parameter to "Enabled".
Configure the "Time for cyclical monitoring of the command values" on the parameter page "O1 - Times" to the required monitoring time. The time set there should agree with the time for cyclical transmission of the command value of the room temperature controller.
Configure the parameter "Value for emergency operation (0...100%)" on the parameter page "O1 - General" to the required valve emergency position. The parameter "Value for emergency operation..." may be visible twice if the operating mode switchover is enabled. In this case, it is possible to specify different valve emergency positions for summer and winter operation in the ETS.

The cyclical command value monitoring is enabled and the communication object "Command value monitoring alarm" becomes visible in the ETS.

In fault-free operation, the command value object of the corresponding valve output must have telegrams transmitted to it cyclically during the monitoring time.

- Set the "Cyclical monitoring of the command value" parameter to "Disabled".
The cyclical monitoring is completely disabled. No telegram monitoring of the command value object is performed.
- i** After bus voltage return and an ETS programming operation, the object "Alarm monitoring command value" is initialised so that the device also transmits a telegram to the bus. After bus voltage return and an ETS programming operation, automatic alarm telegram transmission only takes place when the "Delay after bus voltage return" configured in the ETs has elapsed.
- i** The operating mode (summer / winter) can also be switched over using the object during activated emergency operation. In this case, the device adjusts the pulse width modulation to the valve position value of the valid operating mode immediately after the switchover.

Setting the telegram polarity for the alarm object for command value monitoring

The telegram polarity of the 1-bit "Command value monitoring alarm" object can be set. The configuration of the polarity is possible on parameter page "O1 - Command value".

The cyclical command value monitoring must have been enabled already.

- Set the "Polarity of 'Command value monitoring' object" parameter to "Object value on no command values = 0".
A fault in the command value monitoring (emergency operation) is signalled by an "OFF" telegram (alarm). When the fault is reset (emergency operation terminated) an "ON" telegram is transmitted to the bus (no alarm).
- Set the "Polarity of 'Command value monitoring' object" parameter to "Object value on no command values = 1".

A fault in the command value monitoring (emergency operation) is signalled by an "ON" telegram (alarm). When the fault is reset (emergency operation terminated) an "OFF" telegram is transmitted to the bus (no alarm).

Command value limit

If the valve output is controlled using 1-byte constant command value telegrams, a command value limit can optionally be configured in the ETS. The command value limit allows the restriction of command values specified via the bus to the range limits "minimum" and "maximum". The limits are permanently set in the ETS and, if command value limitation is active, can be neither undershot or exceeded during device operation.

- i** The command value limit cannot be configured in the ETS, if the valve output is configured for 1-bit switching command values.

The command value limit can either be activated or deactivated using a separate 1-bit communication object or be permanently active. When controlling via the object, it is possible to have the device activate the command value limit automatically after bus voltage return or an ETS programming operation.

As soon as the command value limit is active, command values received via the bus and valve setpoint positions specified by emergency operation (cyclical command value monitoring) are limited. If the limit is removed, the device does not automatically track the most recently specified command value or the valve setpoint position to the unlimited values. After the limit, a new command value or valve setpoint position must be specified until new values are set at the valve output.

- i** In the status messages ("Command value status" or "Valve closed") the limited command value is always taken into account and fed back.
- i** The forced position has a higher priority than the command value limit (see chapter 4.2.4.5. Priorities for the output). This means that, in the case of a forced position, the command value setpoint configured in the ETS is always set at the valve output and is not limited by the command value limit.
- i** After an ETS programming operation and on bus voltage return, a constant valve setpoint position value (0...100%) can be configured and activated in the ETS as the "Value for forced position" or "Value for emergency operation". The following should be observed in this case:
The device only uses the valve position values (0...100 %) configured in the ETS. The forced position function or emergency operation are not activated. However, it should be noted that the value for the forced position has a higher priority than a command value limit. Thus, a forced position value set after bus voltage return or after an ETS programming operation is not limited by the command value limit. However, a value for emergency operation can be limited.

Enabling the command value limit

The command value limit can optionally be enabled on parameter page "O1 - Command value".

- Set the parameter "Command value limit" to "enabled".
The command value limit is enabled. Additional parameters become visible in the ETS.
- Set the parameter "Command value limit" to "disabled".
The command value limit is deactivated.

Configuring the activation of the command value limit

The command value limit can either be activated or deactivated using a separate 1-bit communication object or be permanently active. The activation property is configured in the parameter set for command value limiting on parameter page "O1 - Command value".

The command value limit must have been enabled beforehand in the ETS.

- Set the parameter "Activation of the command value limit" to "by object".

The 1-bit object "Command value limit" becomes visible in the ETS. The telegram polarity of this object is fixed: "0" = command value limit inactive / "1" = command value limit active.

As soon as a "1" telegram is received via the object, the device activates the command value limit for the valve output. Only a "0" telegram removes the limit for command value telegrams or valve setpoint position values for emergency operation.

- i** The initialisation of the command value limit object after a device reset is defined by the parameter "Command value limit after bus voltage return" (see "Define behaviour of the command value limit after device reset" below).

- Set the parameter "Activation of the command value limit" to "permanent".

The command value limit is always active and cannot be deactivated. There is no separate communication object available. Only a forced position of the valve output can by-pass the command value limit in normal device operation.

Specifying limit values for the command value limit

As soon as the command value limit is active, command values received via the bus and valve setpoint positions specified by emergency operation (cyclical command value monitoring) are limited. The command values to act as limits must be defined in the ETS as the minimum and maximum command value limit values. The limit values is configured in the parameter set for command value limiting on parameter page "O1 - Command value".

The command value limit must have been enabled beforehand in the ETS.

- Set the Minimum command value parameter to the required command value. The setting can be made in 5 % increments in the range 0 % ... 50 %.

With an active command value limit, the set minimum command value is not undershot by command values from the bus or emergency operation. Should the named functions specify smaller command values, the device sets the minimum command value at the valve output and signals this value, including the status, to the bus (if the status message is enabled).

- Set the Maximum command value parameter to the required command value. The setting can be made in 5 % increments in the range 55 % ... 100 %.

With an active command value limit, the set maximum command value is not exceeded by command values from the bus or emergency operation. Should the named functions specify larger command values, the device sets the maximum command value at the valve output and signals this value, including the status, to the bus (if the status message is enabled).

- i** The forced position has a higher priority than the command value limit. This means that, in the case of a forced position, the command value setpoint configured in the ETS is always set at the valve output and is not limited by the command value limit.

Defining the behaviour of the command value limit after a device reset

If the command value limit is to be activated or deactivated via the object, the initialisation of the object after a device reset (bus voltage return or ETS programming operation) can be specified. This setting is also made in the parameter set for command value limiting on parameter page "O1 - Command value".

With a permanently active command value limit, the initialisation behaviour cannot be configured separately after a device reset, as the limit is always active.

The command value limit must have been enabled beforehand in the ETS.

- Set the parameter "Command value limit after bus voltage return" to "deactivated".
After a device reset, the device does not automatically activate the command value limit. A "1" telegram must first be received via the object before the limit is activated.
- Set the parameter "Command value limit after bus voltage return" to "activated".
After a device reset, the device automatically activates the command value limit. A "0" telegram must first be received via the object before the limit is deactivated. The limit can be switched on or off at any time using the object.

i After a reset, the value of the "Command value limit" object is set according to the configuration and can be read out as necessary (set "Read" flat).

4.2.4.4.3 Settings for the status function

Status message for valve position

The device makes a command value status message available to the valve output. In so doing, the current valve setpoint position can be transmitted to the bus via the communication object "Command value status" according to the projected command value data format (1-bit or 1-byte). In this manner, the state of a valve can be displayed in a visualisation or evaluated further in other bus devices, for example.

The status object is updated after the following events...

- When the command value received from the bus changes,
- When the prespecified valve setpoint position is changed by a forced position or emergency operation,
- Always after an ETS programming operation or bus voltage return,
- Always when a short-circuit or an overload has caused a switch-off of a valve output.

The status object always specifies the value of the valve setpoint position. With constant 1-byte command values, the absolute value of the valve setpoint position is immediately added to the status object according to the KNX data point type 5.001 ("0" = 0% ... "255" = 100%). With switching 1-bit command values, the state "closed" ("0") or "opened" ("1") is added according to the KNX data point type 1.001.

The valve direction of action configured in the ETS is not included in the determination of the status message. The direction of action specifies solely the energising state of the valve output when the valve position is opened or closed.

A constant valve setpoint position (0 % to 100 %) can be activated in the forced position of the valve output, in emergency operation, after an ETS programming operation or after bus voltage return. In these cases, the configured valve setpoint position is executed as pulse width modulation (PWM). This also takes place when the output is configured to a switching 1-bit command value. In so doing, a PWM for valve outputs with 1-bit command value format in the status object is fed back as "Valve opened" ("1").

- i** If there is a short-circuit at the valve output, the connected valve drives are no longer controlled electrically, meaning that the drives switch to the deenergised status preset by the manufacturer (deenergised opened / deenergised closed). With the device status messages ("Command value status", "Valve closed"), a valve completely opened by a short-circuit (valve direction of action deenergised open) is evaluated as a closed valve, as the valve status was caused by a fault.
- i** Anti-sticking protection always runs 'in the background' and is not signalled to the bus using the status objects.

Enabling and configuring the status message for valve position

The configuration of the status message for the valve output is possible on parameter page "O1 - Status".

Irrespective of the data format of the command value, a distinction is made whether the status object of the valve output acts as an actively transmitting signal object or as a passive status object.

The configuration as a signalling or status object is performed in the ETS, which then automatically sets the necessary communication flags of the status object.

- Set the "Transmit status of the valve position ?" parameter to "Status object is actively transmitting".

The status message is enabled. As soon as the device updates the status message, a telegram is also actively transmitted to the bus. In the ETS the "Transmit" flag is set automatically on the status object.

i It is entirely possible, even when a signalling object is active, to set the "Read" flag in the ETS subsequently, in order to keep the read-out functionality of the object.

- Set the "Transmit status of the valve position ?" parameter to "Status object is passively readable".
The status message is enabled. The device updates only the status object internally, and does not transmit any telegram. The object value can be read out via the bus at any time (ValueRead), as a result of which the device then transmits a response telegram (ValueResponse). In the ETS the "Read" flag is set automatically on the status object.
- Set the "Transmit status of the valve position ?" parameter to "No status".
The communication object is hidden in the ETS meaning that the status message is completely inactive.

Setting the time delay after bus voltage return for the status message

It is possible to set a time delay for the actively transmitting status messages after bus voltage return (switching on of the bus voltage), and also after ETS programming. This can be useful, for example, in order to reduce the bus load if after a bus reset several devices are carrying out initialisation of their status or feedback objects at the same time. Here it is advisable to define different time delays in the devices, so that the transmission of the signal telegrams is staggered in time.

For this purpose a delay time can be defined in the device. Only after the configured time elapses is the status telegram for initialisation transmitted to the bus.

Whether the status message is transmitted with a time delay after initialisation can be configured on parameter page "O1 - Status".

The delay time itself is configured on the parameter page "General".

The status message for the valve position must have been enabled as 'actively transmitting' in advance.

- Set the parameter "Time delay for status after bus voltage return" to "Yes".
After the bus voltage supply is switched on or after ETS programming the status telegram is transmitted with a time delay.
- Set the parameter "Time delay for status after bus voltage return" to "No".
After the bus voltage supply is switched on or after ETS programming the status telegram is transmitted to the bus immediately after initialisation.

Status message "All valves closed"

The device can transmit the information to the bus using a 1-bit status telegram, that the valve drives connected to the valve output are closed, i.e. no heating or cooling energy is required via the command value. This status message can be useful, for example, for visualisations or pump control in a heating/cooling system.

Enabling the status message "Valve closed"

The status message can be enabled on parameter page "O1 - Status".

- Set the parameter "Status object 'Valve closed'" to "Enabled".
The "Valve closed" status function is enabled. The "Valve closed" communication object is visible in the ETS.
- Set the parameter "Status object 'Valve closed'" to "Blocked".

The "Valve closed" status function is completely deactivated.

Setting the telegram polarity of the "Valve closed" status message

The telegram polarity of the "Valve closed" communication object can be set in the ETS.

The status message must have been enabled in advance.

- Set the "Polarity object 'Valve closed'" parameter on the "O1 - Status" parameter page to "Object valve on 'Valve closed' = 0".

As soon as all the valve positions are specified as or set to "0 %" or "OFF", i.e. all the connected valves are completely closed, the device transmits an "OFF" telegram to the bus via the status object. As soon as the valves of the valve output are opened by a switching command value or any pulse width modulation, the device transmits an "ON" status telegram to the bus.

- Set the "Polarity object 'Valve closed'" parameter on the "O1 - Status" parameter page to "Object valve on 'Valve closed' = 1".

As soon as all the valve positions are specified as or set to "0 %" or "OFF", i.e. all the connected valves are completely closed, the device transmits an "ON" telegram to the bus via the status object. As soon as the valves of the valve output are opened by a switching command value or any pulse width modulation, the device transmits an "ON" status telegram to the bus.

i The status message takes switching and constant command values into account.

i The valve state configured in the ETS is set after bus voltage return or after an ETS programming operation. In so doing, the status message "Valve closed" is updated according to the current status and a telegram sent to the bus, providing the status message is enabled.

However, transmission shall only take place in the named cases after the delay time after bus voltage return configured in the ETS has elapsed.

i If there is a short-circuit at the valve output, the connected valve drives are no longer controlled electrically, meaning that the drives switch to the deenergised status preset by the manufacturer (deenergised opened / deenergised closed).

With the status message "Valve closed", a valve completely opened by a short-circuit (valve direction of action deenergised open) is evaluated as a closed valve, as the valve status was caused by a fault.

Short-circuit and overload protection

The device monitors the valve output for short-circuits and overloads as soon as the output is switched on and energised.

The device detects short-circuits against the neutral wire potential or a 'current-imposed' overload on the connected electrothermal actuators (Figure 29).

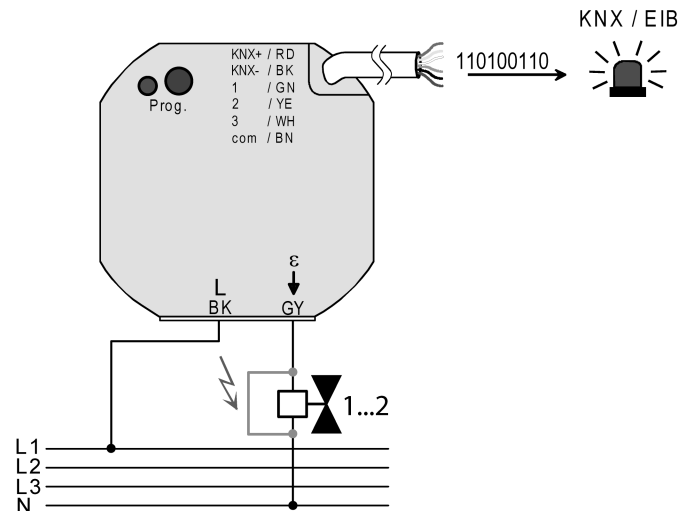

Figure 29: Short-circuit and overload detection in case of fault in valve output or valve drive

Short-circuit and overload detection with switch-off and testing operation:

As soon as a device detects a short-circuit or overload fault, it immediately deenergises the valve output and switches to the Fault status. In the Fault status, it is no longer possible to control the valve output via the bus. The device may still receive command values and forced position telegrams and save them, however it does not execute these telegrams and does not transmit any status feedback to the bus.

Only if the fault has not been eliminated 6 minutes after first detection and is still pending, the device switches to the Fault status and transmits an alarm telegram to the bus. This alarm message can be enabled and evaluated in the ETS. Irrespective of the alarm message, the device transmits a command value status telegram "0 %" or "OFF" to the bus 6 minutes after a fault is detected and thus signals a deactivated valve output

- i** With the status feedback, a valve completely opened by a short-circuit (valve direction of action deenergised open) is evaluated as a closed valve, as the valve status was caused by a fault.

If the fault is no longer pending 6 minutes after first detection (e.g. short switch-on overload), the device shall switch the valve output on for an additional 4 minutes, irrespective of the command value. Only when no new short-circuit or overload is detected within this additional switch-on phase of the testing operation does the device terminate the fault state after the 4 minutes have elapsed without the transmission of an alarm message.

The device then reactivates the added setpoint valve position which was active before the short-circuit or overload fault or which was most recently received from the bus during the fault state. In this way, the device switches the previously switched-off valve output on again, and also updates its status feedback. A forced position is also added, providing that this was activated before or during the fault.

- i** During the fault state, the cyclical command value monitoring is not active. Only when the fault state is reset is the cycle time of the cyclical monitoring restarted.

Resetting a short-circuit/overload fault:

The following procedures are available for recommissioning a valve output made fault by a short-circuit or an overload...

- Switch the bus voltage supply off and on again,
- ETS programming operation.

After the reset, the alarm message is immediately retracted by transmitting an alarm telegram according to the polarity set in the ETS (no alarm).

If, after resetting, the valve output is still overloaded or has a short circuit, the device, when switched on, detects the fault and starts the testing cycle again, as described above.

- i** If there is a short-circuit at the valve output, the connected valve drives are no longer controlled electrically, meaning that the drives switch to the deenergised status preset by the manufacturer (deenergised opened / deenergised closed).
With the status feedback ("Command value status", "Valve closed"), a valve completely opened by a short-circuit (valve direction of action deenergised open) is evaluated as a closed valve, as the valve status was caused by a fault.

Enabling the alarm object before short-circuit / overload detection

Short-circuit and overload detection is always active for the valve output. Optionally, a 1-bit alarm object can be enabled on the parameter page "O1 - Status", allowing the signalling of fault operation due to a short-circuit or overload in the bus.

- Set the "Alarm object for overload / short-circuit" parameter to "enabled".
This enables the short-circuit and overload signalling through the "Short-circuit / overload alarm" object. If the device at the valve output has detected a fault, it transmits an alarm telegram onto the bus after a 6-minute detection time has elapsed, provided that the fault is still pending. The alarm message is only retracted when the fault has been reset.
- Set the "Alarm object for overload / short-circuit" parameter to "disabled".
This deactivates the short-circuit and overload signalling through the "Short-circuit / overload alarm" object. When the device at the valve output detects a fault, the output is switched off and switched to fault operation without an alarm telegram being transmitted.
- i** After bus voltage return, the device retracts a alarm message transmitted before bus voltage failure by transmitting an alarm telegram appropriate to the polarity set in the ETS (no alarm). If, after resetting, the valve output is still overloaded or has a short circuit, the device, when switched on, detects the fault and starts the testing cycle again.
- i** The alarm message is, at first, deactivated after an ETS programming operation. For initialisation, the device transmits an alarm telegram onto the bus according to the polarity set in the ETS (no alarm). Only when a valve output switches on after the ETS programming operation and a fault has been detected does the device switch to fault operation of the valve output and starts the testing operation described above.

Setting the telegram polarity for the alarm object for short-circuit / overload

The telegram polarity of the 1-bit "Short-circuit / overload alarm" object can be set. The configuration of the polarity is possible on parameter page "O1 - Status".

The alarm object must have been enabled already.

- Set the "Polarity of 'Overland / short-circuit alarm" parameter to "Object value on overload / short-circuit = 0".
A short-circuit or overload fault is signalled by an "OFF" telegram (alarm). When the fault is reset, an "ON" telegram is transmitted to the bus (no alarm).
- Set the "Polarity of 'Overland / short-circuit alarm" parameter to "Object value on overload / short-circuit = 1".

A short-circuit or overload fault is signalled by an "ON" telegram (alarm). When the fault is reset, an "OFF" telegram is transmitted to the bus (no alarm).

Setting the time delay after bus voltage return for the short-circuit / overload alarm message

After bus voltage return, any alarm message transmitted before the bus voltage failure is always withdrawn (no alarm). Even if no alarm message was active before the bus failure, a message telegram (no alarm) is transmitted to bus for initialisation after bus voltage return or an ETS programming operation.

In these cases, the transmission of the alarm telegram may take place after a delay. The configuration of the time delay is possible on parameter page "O1 - Status".

The alarm object must have been enabled already.

- Set the parameter "Time delay for message after bus voltage return ?" to "Yes".
The time delay after a bus voltage return or an ETS programming operation is activated for the alarm message. The delay time is defined together with the Venetian blind and valve output using the parameter "Delay after bus voltage return (0...59 s)" on the parameter page "General".
- Set the parameter "Time delay for message after bus voltage return ?" to "Yes".
The time delay after a bus voltage return or an ETS programming operation is deactivated for the alarm message. The alarm telegram is transmitted immediately after the device initialisation.

4.2.4.5 Priorities for the output

The device distinguishes between different functions that can have an effect on the valve output. In order to prevent conflicting states, each available function has a certain priority. The function with the higher priority overrides the one with the lower priority.

For valve output there are the following priorities...

- 1st priority: short-circuit / overload (highest priority)
- 2nd priority: anti-sticking protection
- 3th priority: forced position via object
- 4th priority: command value limit
- 5th priority: direct operation via the bus (command value evaluation) / emergency operation

4.2.5 Delivery state

Delivery state

In the state as delivered, the device is passive, i.e. no telegrams are transmitted to the bus. The device can be programmed and put into operation via the ETS. The physical address is preset to 15.15.255

Moreover the device has been configured at the factory with the following characteristics...

For output 1 (valve output)

- Valve direction of action (valve in deenergised state): closed
- Behaviour on bus voltage failure: output OFF (valve in deenergised state)
- Behaviour after bus voltage return: valve closes
- Cycle time (PWM of the outputs): 15 minutes, 10 seconds
- No cyclical command value monitoring

For inputs 1...3 (extension inputs)...

- No function

4.2.6 Parameters

4.2.6.1 General parameters

Description	Values	Comment
<p>☐ General</p> <p>Output (O1)...</p>		
<p>Delay after bus voltage return Minutes (0...59)</p>	<p>0...59</p>	<p>To reduce telegram traffic on the bus line after bus voltage activation (bus reset), after connection of the device to the bus line or after programming with the ETS, it is possible to delay all actively transmitted feedback telegrams of the actuator output. For this purpose a channel-independent delay time can be defined here for output 1. Only after the configured time elapses are feedback telegrams for initialisation transmitted to the bus.</p> <p>Setting of the delay time minutes for the actuator output.</p>
<p>Seconds (0...59)</p>	<p>0...17...59</p>	<p>Setting of the delay time seconds for the actuator output.</p>
<p>Extension inputs (I1, I2, I3)...</p>		
<p>Delay after bus voltage return Minutes (0...59)</p>	<p>0...59</p>	<p>It is possible to specify separately for each input whether a reaction should take place after a device reset (bus voltage return or ETS programming operation). This means that a defined telegram can be transmitted to the bus according to the input signal or with forced control. The delay time for the extension inputs configurable at this point must have elapsed fully by the time the set reaction is executed. Within the delay, any pending flanks or signals at the inputs are not evaluated and are ignored.</p> <p>Minute setting of the delay time for the extension inputs.</p>
<p>Seconds (0...59)</p>	<p>0...17...59</p>	<p>Second setting of the delay time for the extension inputs.</p>
<p>Telegram rate limit</p>	<p>disabled Enabled</p>	<p>Here it is possible to configure a general telegram rate limit. If the telegram rate limit is enabled, no more telegrams are transmitted to the bus in 17 seconds (permanently defined, cyclical time interval) than is specified by the parameter "Telegrams per 17 s". This avoids fast flank changes at the inputs causing an unpermissibly high bus load.</p>

Telegrams per 17 s **30**, 60, 100, 127

Setting the telegram rate (telegrams in 17 s) for the telegram rate limit. Only visible on "Telegram rate limit = enabled".

4.2.6.2 Parameters for the extension inputs

Description	Values	Comment
□↵ Input X - General (x = 1, 2, 3)		
Function input x (X = 1...3)	No function Switching Dimming Venetian blind Value transmitter	The basic function of the appropriate extension input is defined here. In the "No function" setting, the extension input is deactivated.
The following parameters are visible for the function "Switching"...		
Command on rising flank Switching object 1.1	No reaction ON OFF TOGGLE	This parameter can be used to define which object value is transmitted first to the bus via the first communication object of the input when there is a rising flank (TOGGLE - switchover of the object value).
Command on falling flank Switching object 1.1	No reaction ON OFF TOGGLE	This parameter can be used to define which object value is transmitted first to the bus via the first communication object of the input when there is a falling flank (TOGGLE - switchover of the object value).
Command on rising flank Switching object 1.2	No reaction ON OFF TOGGLE	This parameter can be used to define which object value is transmitted first to the bus via the second communication object of the input when there is a rising flank (TOGGLE - switchover of the object value).
Command on falling flank Switching object 1.2	No reaction ON OFF TOGGLE	This parameter can be used to define which object value is transmitted first to the bus via the second communication object of the input when there is a falling flank (TOGGLE - switchover of the object value).
Behaviour after bus voltage return		After a device reset (bus voltage return or ETS programming operation), the communication objects of the input can be initialised. If, in the ETS, a delay is set for the extension inputs after bus voltage return, the device only transmits the telegrams when the delay has elapsed.
	No reaction	After a device reset, no reaction takes place automatically (no telegram is transmitted to the bus).
	Send ON telegram	

	In this configuration, an "ON" telegram is actively transmitted to the bus after a device reset.
Send OFF telegram	In this configuration, an "OFF" telegram is actively transmitted to the bus after a device reset.
Transmit current input status	In this setting, the device evaluates the static signal status of the input and, according to this, transmits the appropriately configured telegram to the bus (contact closed at the input = telegram as with rising flank; contact open at input = telegram as with falling flank). If, in this case, the flank command dependent on the current status is configured to "No reaction", the device does not transmit a telegram to the bus on initialisation.

The following parameters are visible for the function "Dimming"...

Operation	This parameter specifies the reaction to a rising flank at the input.
Single-surface operation: Brighter / darker (TOGGLE)	With a short signal length at the input, the object value of the switching object is toggled and an appropriate telegram transmitted. With a long signal length, a dimming telegram (brighter / darker). The dimming direction is only stored internally and switched on sequential dimming operations.
Two button operation: Brighter (ON)	With a short signal length at the input, an ON telegram is triggered and, if there is a long signal length, a dimming telegram (brighter) is triggered.
Two button operation: Darker (OFF)	With a short signal length at the input, an OFF telegram is triggered and, if there is a long signal length, a dimming telegram (darker) is triggered.
Two button operation: Brighter (TOGGLE)	With a short signal length at the input, the object value of the switching object is toggled and an appropriate telegram transmitted, if there is a long signal length, a dimming telegram (brighter) is triggered.
Two button operation: Darker (TOGGLE)	With a short signal length at the input, the object value of the switching object is toggled and an appropriate telegram transmitted, if there is a long signal length, a dimming telegram (darker) is triggered.
Time between switching and dimming Seconds (0...59) 0...59	Time from which the dimming function ("long signal length") is executed. Sets the time seconds.

Milliseconds (4...9 x 100)	4...9	Sets the time milliseconds.
Behaviour after bus voltage return	No reaction	After a device reset (bus voltage return or ETS programming operation), the communication object "Switching" of the input can be initialised. If, in the ETS, a delay is set for the extension inputs after bus voltage return, the device only transmits the telegrams when the delay has elapsed.
	Send ON telegram	After a device reset, no reaction takes place automatically (no telegram is transmitted to the bus).
	Send OFF telegram	In this configuration, an "ON" telegram is actively transmitted to the bus after a device reset.
		In this configuration, an "OFF" telegram is actively transmitted to the bus after a device reset.
Increase brightness by	100 %	A dimming telegram can increase brightness by a maximum of X %. This parameter determines the maximum dimming increments for a dimming telegram. This parameter depends on the set operation.
	50 %	
	25 %	
	12.5 %	
	6 %	
	3 %	
Reduce brightness by	100 %	A dimming telegram can increase darkness by a maximum of X %. This parameter determines the maximum dimming increments for a dimming telegram. This parameter depends on the set operation.
	50 %	
	25 %	
	12.5 %	
	6 %	
	3 %	
Transmit stop telegram?	No yes	One or no telegram is transmitted on releasing a pushbutton at the input (falling flank).
Telegram repeat?	No Yes	It is possible to use this parameter to determine whether the dimming telegram should be repeated cyclically for a long signal length (actuation of a pushbutton at the input).
Time between two telegrams Seconds (0...59)	0...1...59	Time between two telegrams when telegram repetition is active. A new dimming telegram is transmitted after this time has elapsed. Sets the time seconds.

Milliseconds (5...9 x 100) **5...9** Sets the time milliseconds.

The following parameters are visible for the function "Venetian Blind"...

Command on rising flank	<p>No function</p> <p>UP</p> <p>DOWN</p> <p>TOGGLE</p>	<p>This parameter specifies the reaction to a rising flank at the input.</p> <p>The input is deactivated.</p> <p>A short time telegram (UP) is triggered by a short signal length and a long time telegram (high) is triggered by a long signal length.</p> <p>A short time telegram (DOWN) is triggered by a short signal length and a long time telegram (low) is triggered by a long signal length.</p> <p>With this setting, the direction is switched over internally long signal length (MOVE). If a short time signal transmits a STEP telegram, then this STEP is always switched in the opposite direction of the last MOVE. Several STEP telegrams transmitted successively are switched in the same direction.</p>
Behaviour after bus voltage return	<p>No reaction</p> <p>Up</p> <p>Down</p>	<p>After a device reset (bus voltage return or ETS programming operation), the communication object "Long time operation" of the input can be initialised. If, in the ETS, a delay is set for the extension inputs after bus voltage return, the device only transmits the telegrams when the delay has elapsed.</p> <p>After a device reset, no reaction takes place automatically (no telegram is transmitted to the bus).</p> <p>In this configuration, an "UP" telegram is actively transmitted to the bus after a device reset.</p> <p>In this configuration, an "DOWN" telegram is actively transmitted to the bus after a device reset.</p>
Operation concept	<p>Short - long - short</p>	<p>This parameter specifies the telegram sequence after actuation (rising flank).</p> <p>A STEP is transmitted with a rising flank and the "Time between short and long time operation" started. This STEP serves the purpose of stopping a continuous movement. If, within the started time, a falling flank is detected, the input does not transmit an additional telegram. If no falling flank was detected</p>

		<p>during the time, a MOVE is transmitted automatically after the time has elapsed and the "slat adjustment time" is started. If a falling flank is detected within the slat adjustment time, the input transmits a STEP. This function is used for slat adjustment.</p> <p>Long - short</p> <p>A MOVE is transmitted when there is a rising flank at the input and the "slat adjustment time" started. If a falling flank is detected within the started time, the input transmits a STEP. This function is used for slat adjustment.</p>
Time between step and move operation Seconds (0...59)	0...59	<p>Time after which the function of a long actuation is executed. Only visible with "Operation concept = "Short – Long – Short". Sets the time seconds.</p>
Milliseconds (4...9 x 100)	4...9	<p>Sets the time milliseconds.</p>
Slat moving time Seconds (0...59)	0...2...59	<p>Time during which a long time telegram for slat adjustment can be terminated by a falling flank at the input. Sets the time seconds.</p>
Milliseconds (0...9 x 100)	0...9	<p>Sets the time milliseconds.</p>

The following parameters are visible for the function "Value encoder"...

Function as	<p>Dimming value encoder</p> <p>Scene recall without storage function</p> <p>Scene recall with storage function</p> <p>Temperature value transmitter</p> <p>Brightness value transmitter</p>	<p>This parameter specifies the value transmitter function to be executed. The data format of the value object is dependent on the set function of the value encoder.</p>
Transmit value / light scene number on	<p>rising flank (pushbutton as NO contact)</p> <p>falling flank (pushbutton as NC contact)</p> <p>rising and falling flank (switch)</p>	<p>This parameter specifies the flank which starts signal evaluation in the device. The setting "rising and falling flank (switch)" cannot be selected with the value encoder function "Light scene recall with memory function".</p>

Value on rising flank (0...255)	0... 100 ...255	This parameter specifies the value transmitted on a rising flank. Only visible with "Dimming value encoder" and "Transmit value on = rising flank (pushbutton as NO contact)" and "Transmit value on = rising and falling flank (switch)".
Value on falling flank (0...255)	0 ...255	This parameter specifies the value transmitted on a falling flank. Only visible with "Dimming value encoder" and "Transmit value on = falling flank (pushbutton as NC contact)" and "Transmit value on = rising and falling flank (switch)".
Light scene number on rising flank (1...64)	1 ...64	This parameter specifies the light scene number transmitted on a rising flank. Only visible with "Light scene recall" and "Transmit value on = rising flank (pushbutton as NO contact)" and "Transmit value on = rising and falling flank (switch)".
Light scene number on falling flank (1...64)	1 ...64	This parameter specifies the light scene number transmitted on a falling flank. Only visible with "Light scene recall" and "Transmit value on = falling flank (pushbutton as NC contact)" and "Transmit value on = rising and falling flank (switch)".
Value on rising flank	0 °C... 20 °C ...40 °C	This parameter specifies the temperature value transmitted on a rising flank. Only visible with "Temperature value encoder" and "Transmit value on = rising flank (pushbutton as NO contact)" and "Transmit value on = rising and falling flank (switch)".
Value on falling flank	0 °C... 18 °C ...40 °C	This parameter specifies the temperature value transmitted on a falling flank. Only visible with "Temperature value encoder" and "Transmit value on = falling flank (pushbutton as NC contact)" and "Transmit value on = rising and falling flank (switch)".
Value on rising flank	0 Lux... 200 Lux ...1.500 Lux	This parameter specifies the brightness value transmitted on a rising flank. Only visible with "Brightness value encoder" and "Transmit value on =

		rising flank (pushbutton as NO contact)" and "Transmit value on = rising and falling flank (switch)".
Value on falling flank	0 Lux...1,500 Lux	This parameter specifies the brightness value transmitted on a falling flank. Only visible with "Brightness value encoder" and "Transmit value on = falling flank (pushbutton as NC contact)" and "Transmit value on = rising and falling flank (switch)".
Behaviour after bus voltage return		After a device reset (bus voltage return or ETS programming operation), the communication object of the value encoder or light scene extension can be initialised. If, in the ETS, a delay is set for the extension inputs after bus voltage return, the device only transmits the telegrams when the delay has elapsed.
	No reaction	After a device reset, no reaction takes place automatically (no telegram is transmitted to the bus).
	Reaction as rising flank	In this configuration, a telegram is actively transmitted to the bus after a device reset in accordance with the configuration for the rising flank.
	Reaction as falling flank	In this configuration, a telegram is actively transmitted to the bus after a device reset in accordance with the configuration for the falling flank.
	Transmit current input status	In this setting, the device evaluates the static signal status of the input and, according to this, transmits the appropriately configured telegram to the bus (contact closed at the input = telegram as with rising flank; contact open at input = telegram as with falling flank). This setting can only be configured with "Transmit value on = rising and falling flank (switch)".
Adjustment via long actuation	No Yes	With the dimming value encoder and the temperature and brightness value encoder, the value to be transmitted can be adjusted at any time during device operation. A value adjustment can only be configurable here when the value is to be transmitted only on a rising flank or only on a falling flank, i.e. a pushbutton is connected to the input. A value adjustment is introduced by a long signal at the input (> 5 s) and continues for as long as the signal is detected as active, i.e. the pushbutton is actuated.

With the first adjustment after commissioning, the value programmed by the ETS is increased cyclically by the step width configured for the dimming value encoder and transmitted. The step width of the temperature value encoder (1 °C) and the brightness value encoder (50 Lux) is permanently defined. The previously transmitted value is saved after releasing the pushbutton. The next long pushbutton actuation adjusts the saved value and the direction of the value adjustment changes. Only visible with "Transmit value on = rising flank (pushbutton as NO contact)" and "Transmit value on = falling flank (pushbutton as NC contact)".

Time between two telegrams Seconds (0...59)	0...1...59	The time between two telegrams on adjusting values can be configured here. Only visible on "Adjustment via long actuation = Yes". Sets the time seconds.
Milliseconds (5...9 x 100)	5...9	Sets the time milliseconds.
Level size (1...10)	1...10	Increments by which the adjusted value is increased or decreased with long actuation. Only visible on "Function as = Dimming value encoder".

Input x - disable (X = 1, 2, 3) - Only for "Switching" function!

Disabling function switching object 1.1	disabled Enabled	The extension inputs can be separately disabled via the bus using 1-bit objects. With the "Switching" function, it is possible to disable the two switching objects of an input independently of each other. With an active disabling function, signal flanks at the input are ignored by the device related to the affected objects. This parameter enables the disabling function of the first communication object.
Polarity of the disabling object	Disable = 1 (Enable = 0) Disable = 0 (Enable = 1)	This parameter defines the polarity of the disabling object.
Behaviour at the beginning of the disabling function Switching object 1.1	No reaction ON OFF TOGGLE	With an active disable, the first switching object is disabled. This parameter specifies the command transmitted via this object at the beginning of the disabling. "TOGGLE" switches over the

		current object value.
Behaviour at the end of the disabling function Switching object 1.1	No reaction ON OFF Transmit current input status	With an active disable, the first switching object is disabled. This parameter specifies the command transmitted via this object at the end of the disabling. "TOGGLE" switches over the current object value. In the "Transmit current input status" setting, the device evaluates the current static signal status of the input and, according to this, transmits the appropriately configured telegram to the bus (contact closed at the input = telegram as with rising flank; contact open at input = telegram as with falling flank).
Disabling function switching object 1.2	disabled Enabled	The extension inputs can be separately disabled via the bus using 1-bit objects. With the "Switching" function, it is possible to disable the two switching objects of an input independently of each other. With an active disabling function, signal flanks at the input are ignored by the device related to the affected objects. This parameter enables the disabling function of the second communication object.
Polarity of the disabling object	Disable = 1 (Enable = 0) Disable = 0 (Enable = 1)	This parameter defines the polarity of the disabling object.
Behaviour at the beginning of the disabling function Switching object 1.2	No reaction ON OFF TOGGLE	With an active disable, the second switching object is disabled. This parameter specifies the command transmitted via this object at the beginning of the disabling. "TOGGLE" switches over the current object value.
Behaviour at the end of the disabling function Switching object 1.2	No reaction ON OFF Transmit current input status	With an active disable, the second switching object is disabled. This parameter specifies the command transmitted via this object at the end of the disabling. "TOGGLE" switches over the current object value. In the "Transmit current input status" setting, the device evaluates the current static signal status of the input and, according to this, transmits the appropriately configured telegram to the bus (contact closed at the input = telegram as with rising flank; contact open at input = telegram as with falling flank).

☐ Input x - disable (X = 1, 2, 3) - Only for "Dimming" function!

Disabling function	disabled Enabled	The extension inputs can be separately disabled via the bus using 1-bit objects. With an active disabling function, signal flanks at the input are ignored by the device related to the affected objects. This parameter enables the disabling function of the input.
--------------------	----------------------------	---

Polarity of the disabling object	Disable = 1 (Enable = 0) Disable = 0 (Enable = 1)	This parameter defines the polarity of the disabling object.
----------------------------------	---	--

Behaviour at the beginning of the disabling function	No reaction ON OFF TOGGLE	With an active disable, the input is disabled. This parameter specifies the command transmitted via the "Switching" object at the beginning of the disabling. "TOGGLE" switches over the current object value.
--	---	--

Behaviour at the end of the disabling function	No reaction OFF	With an active disable, the input is disabled. This parameter specifies the command transmitted via the "Switching" object at the end of the disabling.
--	---------------------------	---

☐ Input x - disable (X = 1, 2, 3) - Only for "Venetian blind" function!

Disabling function	disabled Enabled	The extension inputs can be separately disabled via the bus using 1-bit objects. With an active disabling function, signal flanks at the input are ignored by the device related to the affected objects. This parameter enables the disabling function of the input.
--------------------	----------------------------	---

Polarity of the disabling object	Disable = 1 (Enable = 0) Disable = 0 (Enable = 1)	This parameter defines the polarity of the disabling object.
----------------------------------	---	--

Behaviour at the beginning of the disabling function	No reaction Up Down Toggle	With an active disable, the input is disabled. This parameter specifies the command transmitted via the "Long time operation" object at the beginning of the disabling. "TOGGLE" switches over the current object value.
--	--	--

Behaviour at the end of the disabling function	No reaction Up	With an active disable, the input is disabled. This parameter specifies the command transmitted via the "Long time
--	--------------------------	--

Down
Toggle

operation" object at the end of the disabling. "TOGGLE" switches over the current object value.

☐ Input x - disable (X = 1, 2, 3) - Only for "Value encoder" function!

Disabling function

disabled
Enabled

The extension inputs can be separately disabled via the bus using 1-bit objects. With an active disabling function, signal flanks at the input are ignored by the device related to the affected objects. This parameter enables the disabling function of the input.

Polarity of the disabling object

Disable = 1 (Enable = 0)
Disable = 0 (Enable = 1)

This parameter defines the polarity of the disabling object.

Behaviour at the beginning of the disabling function

No reaction
Reaction as rising flank
Reaction as falling flank
Transmit current input status

With an active disable, the input is disabled. This parameter specifies the command transmitted via the value object at the beginning of the disabling. In the "Transmit current input status" setting, the device evaluates the static signal status of the input and, according to this, transmits the appropriately configured telegram to the bus (contact closed at the input = telegram as with rising flank; contact open at input = telegram as with falling flank). The selection of the settings of this parameter depends on the configured flank evaluation of the input.

Behaviour at the end of the disabling function

No reaction
Reaction as rising flank
Reaction as falling flank
Transmit current input status

With an active disable, the input is disabled. This parameter specifies the command transmitted via the value object at the end of the disabling. In the "Transmit current input status" setting, the device evaluates the static signal status of the input and, according to this, transmits the appropriately configured telegram to the bus (contact closed at the input = telegram as with rising flank; contact open at input = telegram as with falling flank). The selection of the settings of this parameter depends on the configured flank evaluation of the input.

☐ Input x - Transmit cyclically (X = 1, 2, 3) - Only for "Switching" function!

Cyclical transmission ?

Optionally, the object values can be transmitted cyclically to the bus for the "Switching" function. For this, the transmission criteria must first be

		defined in the ETS. This parameter specifies with which value cyclical transmission should take place. The object value entered in the switching objects by the device on a flank change or externally by the bus is always transmitted cyclically. The object value is then also transmitted cyclically when "no reaction" is assigned to a rising or falling flank. Cyclical transmission also takes place directly after bus voltage return, if the reaction after bus voltage return corresponds to the transmission criterion for cyclical transmission. During an active disable, no cyclical transmissions take place via the disabled input.
	No cyclical transmission	There is no cyclical transmission.
	Repeat on ON	Transmission takes place cyclically when the object value is "ON".
	Repeat on OFF	Transmission takes place cyclically when the object value is "OFF".
	Repeat on ON and OFF	Transmission takes place cyclically irrespective of the object value.
Cyclical transmission Switching object 1.1 ?	yes No	Here, it is possible to specify whether cyclical transmission should take place via the first switching object of the input.
Time for cyclical transmission Hours (0...23)	0...23	If cyclical transmission should take place via the first switching object of the input, then the cycle time can be configured here. Sets the cycle time hours.
Minutes (0...59)	0...59	Sets the cycle time minutes.
Seconds (0...59)	0...30...59	Sets the cycle time seconds.
Cyclical transmission Switching object 1.2 ?	Yes No	Here, it is possible to specify whether cyclical transmission should take place via the second switching object of the input.
Time for cyclical transmission Hours (0...23)	0...23	If cyclical transmission should take place via the second switching object of the input, then the cycle time can be configured here. Sets the cycle time hours.
Minutes (0...59)	0...59	Sets the cycle time minutes.
Seconds (0...59)	0...30...59	Sets the cycle time seconds.

4.2.6.3 Parameters for the valve output

Description	Values	Comment
□ Output 1 - General		
Valve direction of action (valve in deenergised state)	closed	Valve drives, which are closed in the deenergised state, and valve drives, which open in the deenergised state, can be connected to the valve output of the device. For the device to control the valve drives 'with the correction direction of action', the valve direction of action of the connected drives must be configured here.
	opened	
Forced position via object		With the forced position of a valve output, a constant valve forced position (0 % to 100 %) can be stored in the device, which is applied as the valve setpoint in an activated forced position and which is executed by a pulse width modulation. The valve forced position can be set in the ETS differently for summer and winter operation, if the operating mode switchover is enabled.
	disabled	The forced position function is deactivated, meaning that the appropriate object is not visible in the ETS.
	Enabled	The forced position function is enabled and the 1-bit communication object "Forced position" is visible in the ETS.
Summer/winter mode switchover ?		Constant valve position values (0...100%) can be configured in the ETS for the forced position function and emergency operation. If a forced position or emergency operation was activated, the device switches the specified valve position at the valve output using pulse width modulation. It is possible to specify different valve position values for summer and winter in the ETS. For the device to be able to distinguish between the summer and winter valve position values for the forced position function and emergency operation, the operating mode switchover must be enabled here.
	Yes	The operating mode switchover for summer and winter operation is enabled. The 1-bit communication object "Summer/winter switchover" becomes visible in the ETS.

	No	The operating mode switchover for summer and winter operation is disabled. Only one valve position value can be configured separately for the forced position function and emergency operation in the ETS.
Polarity of "Summer/winter switchover" object	Summer = 1 / Winter = 0 Summer = 0 / Winter = 1	The telegram polarity of the 1-bit "Summer/winter switchover" communication object can be set here. This parameter is only visible if the summer/winter operation switchover is enabled.
Operating mode after device reset	Winter mode Summer mode	After an ETS programming operation or bus voltage return, the device automatically initialises the value of the communication object "Summer/winter switchover". The initialisation value is configured here. This parameter is only visible if the summer/winter operation switchover is enabled.
Value for forced position ... (0...100%)	0... 40 ...100	As soon as an "ON" telegram was received via the "Forced position" object, the device activates the forced position for the valve output and controls the valve drive to the valve forced position value specified here. The value configured here can also be used as a valve setpoint position value after an ETS programming operation and bus voltage return. This parameter is available twice if the operating mode switchover (summer/winter) is enabled.
Value for emergency operation ... (0...100%)	0... 50 ...100	If, during cyclical command value monitoring, a missing command value telegram was detected, the device activates emergency operation for the valve output and controls the valve drive to the valve emergency position value specified here. The value configured here can also be used as a valve setpoint position value after an ETS programming operation and bus voltage return. This parameter is available twice if the operating mode switchover (summer/winter) is enabled.
Anti-sticking protection	disabled Enabled	The device possesses automatic anti-sticking protection, in order to prevent calcification or sticking of a valve which

		has not been operated for some time.
Behaviour after bus voltage return		The state of the value output on bus voltage return can be configured here.
	Valve closes	After bus voltage return, the device closes the connected valve drives completely.
	Valve opens	After bus voltage return, the device opens the connected valve drives completely.
	Valve to value for forced position	The device sets the connected valve drives to the value for the forced position (0...100 %) configured in the ETS. In the 0 % setting, the output is closed completely, whilst, in the 100 % setting it is completely opened.
	Valve to value for emergency operation	The device sets the connected valve drives to the value for emergency operation (0...100 %) configured in the ETS. In the 0 % setting, the output is closed completely, whilst, in the 100 % setting it is completely opened.
	State before bus failure	After bus voltage return, the state last selected and internally stored <u>before</u> bus voltage failure (last command value/ valve setpoint position and state of the "Forced position" object) will be tracked. The energisation of the valve output always takes place taking the set valve direction of action into account.
Behaviour of all valve outputs after ETS programming		The state of a valve drive connected to the valve output after an ETS programming operation can be set here. This means that the behaviour can be configured independently to the behaviour after the bus voltage return. The energisation of the valve outputs always takes place taking the set valve direction of action of each output into account.
	Close valves	After an ETS programming operation, the device closes the connected valve drives completely.
	Open valves	After an ETS programming operation, the device opens the connected valve drives completely.
	Valves to value for forced position	The device sets the connected valve drives to the value for the forced position (0...100 %) configured in the ETS. In the 0 % setting, the output is closed completely, whilst, in the 100 % setting it is completely opened.

Valves to value for emergency operation

The device sets the connected valve drives to the value for emergency operation (0...100 %) configured in the ETS. In the 0 % setting, the output is closed completely, whilst, in the 100 % setting it is completely opened.

In the settings 1...99 % for the forced position or emergency operation value, the device carries out PWM at the valve output after an ETS programming operation until a new command value or another function is specified or activated. In this case, the PWM is also executed after an ETS programming operation, if the command value is configured to "switching (1-bit)".

Output 1 - Times

Cycle time (PWM of the valve output)
Minutes (0...20)

0...**15**...20

The cycle time specifies the switching frequency of a pulse width modulated output signal. The variable adjustment option of the cycle time here allows adaptation to the adjusting cycle times (the adjusting time it takes the drive to bring the valve from its completely closed to its completely opened position) of the actuators used.
Sets the cycle time minutes.

Seconds (10...59)

10...59

Sets the cycle time seconds.

Time for cycl. monitoring of command values
Minutes (1...59)

1...**30**...59

The device offers the option of monitoring the command value of the valve output. This monitoring checks whether command value telegrams have been received within the time interval defined here. If there are no telegrams during the monitoring time, the device activates emergency operation and adjusts the connected valve drives to an emergency operation valve position configured in the ETS.

Output 1 - Command value

Type of command value

The valve output can be controlled via switching with a 1-bit command value telegram or alternatively constantly with a 1-byte command value telegram. Constant command values are converted via pulse width modulation at the output.

Switching (1 bit)

In normal operation, the switching telegram received via the 1-bit "Command value" object, is directly

		<p>forwarded to the valve output, taking the valve direction of action (deenergised open / deenergised closed) into account. This means that, if an "ON" telegram is received, the valve is completely opened (output energised on valve direction of action = closed / output deenergised on valve direction of action = opened). If an "OFF" telegram is received, the valve is completely closed (output deenergised on valve direction of action = closed / output energised on valve direction of action = opened).</p>
	Constant (1 byte)	<p>In normal operation, the value telegram received via the 1-byte "Command value" object is converted into an equivalent pulse width modulated switching signal at the valve output. Taking the cycle time set in the device into account, the average output signal resulting from this modulation is a measure of the centred valve position of the control valve and thus a reference for the set room temperature.</p>
Cyclical monitoring of the command value		<p>The device offers the option of monitoring the command value of the valve output. This monitoring checks whether command value telegrams have been received within a time interval that can be defined in the ETS. If there are no telegrams during the monitoring time, the device activates emergency operation and adjusts the connected valve drives to an emergency operation valve position configured in the ETS.</p>
	disabled	<p>The cyclical command value monitoring is enabled and the communication object "Command value monitoring alarm" becomes visible in the ETS. In fault-free operation, the command value object of the valve output must have telegrams transmitted to it cyclically during the monitoring time.</p>
	Enabled	<p>The cyclical monitoring is completely disabled. No telegram monitoring of the command value object is performed.</p>
Polarity of "Command value monitoring alarm" object	<p>Object value when command values absent = 0</p> <p>Object value when command values absent = 1</p>	<p>The telegram polarity of the 1-bit "Command value monitoring alarm" object can be set here. This parameter is only visible with enabled cyclical command value monitoring.</p>
Command value limit		

	disabled	<p>If the valve output is controlled using 1-byte constant command value telegrams, a command value limit can optionally be configured here. The command value limit allows the restriction of command values specified via the bus to the range limits "minimum" and "maximum". The limits are permanently set in the ETS and, if command value limitation is active, can be neither undershot or exceeded during device operation.</p>
	Enabled	
Activation of the command value limit		<p>The command value limit can either be activated or deactivated using a separate 1-bit communication object or be permanently active. The activation property is configured here.</p>
	By object	<p>The 1-bit object "Command value limit" becomes visible in the ETS. The telegram polarity of this object is fixed: "0" = command value limit inactive / "1" = command value limit active. As soon as a "1" telegram is received via the object, the device activates the command value limit for the valve output. Only a "0" telegram removes the limit for command value telegrams or valve setpoint position values for emergency operation.</p>
	Permanent	<p>The command value limit is always active and cannot be deactivated. There is no separate communication object available. Only a forced position of the valve output can by-pass the command value limit in normal device operation.</p>
Minimum command value	0 %...50 % (in 5 % increments)	<p>As soon as the command value limit is active, command values received via the bus and valve setpoint positions specified by emergency operation (cyclical command value monitoring) are limited. The command value to be limited in a downwards direction must be defined as a minimum command value limit value by this parameter. With an active command value limit, the set minimum command value is not undershot by command values from the bus or emergency operation. Should the named functions specify smaller command values, the device sets the minimum command value at the valve output and signals this value, including the status, to the bus (if the status message is enabled).</p>

<p>Maximum command value</p>	<p>55 %...100 % (in 5 % increments)</p>	<p>As soon as the command value limit is active, command values received via the bus and valve setpoint positions specified by emergency operation (cyclical command value monitoring) are limited. The command value to be limited in an upwards direction must be defined as a maximum command value limit value by this parameter. With an active command value limit, the set maximum command value is not exceeded by command values from the bus or emergency operation. Should the named functions specify larger command values, the device sets the maximum command value at the valve output and signals this value, including the status, to the bus (if the status message is enabled).</p>
<p>Command value limit after bus voltage return</p>	<p>Deactivated Activated</p>	<p>If the command value limit is to be activated or deactivated via the object, the initialisation of the object after a device reset (bus voltage return or ETS programming operation) can be specified here. With a permanently active command value limit, the initialisation behaviour cannot be configured separately after a device reset, as the limit is always active. In this case, the parameter is permanently preset to "activated".</p>
<p><input type="checkbox"/> Output 1 - Status Transmit status of the valve position?</p>	<p>No status</p> <p>Status object is actively transmitting</p> <p>Status object is passively readable</p>	<p>The device makes a command value status message available to the valve output. In so doing, the current valve setpoint position can be transmitted to the bus via the communication object "Command value status" according to the projected command value data format (1-bit or 1-byte).</p> <p>The communication object is hidden in the ETS meaning that the status message is completely inactive.</p> <p>The status message is enabled. As soon as the device updates the status message, a telegram is also actively transmitted to the bus. In the ETS the "Transmit" flag is set automatically on the status object.</p> <p>The status message is enabled. The device updates only the status object internally, and does not transmit any telegram. The object value can be read out via the bus at any time (ValueRead), as a result of which the device then</p>

		transmits a response telegram (ValueResponse). In the ETS the "Read" flag is set automatically on the status object.
Time delay for status after bus voltage return ?	Yes No	It is possible to set a time delay for the actively transmitting status messages after bus voltage return (switching on of the bus voltage), and also after ETS programming. For this purpose a delay time can be defined in the device. Only after the configured time elapses are status telegrams for initialisation transmitted to the bus. Whether the status message is transmitted with a time delay after initialisation can be configured here. The delay time itself is configured independent of the channel on the parameter page "General". This parameter is only visible in "Transmit status of the valve position?" = "Status object is actively transmitting".
Status object "Valve closed"	disabled Enabled	The device can transmit the information to the bus using a 1-bit status telegram, that the valve is closed, i.e. no heating or cooling energy is required via the command value. The status message can be enabled here.
Polarity object "Valve closed"	Object value on "Valve closed" = 0 Object value on "Valve closed" = 1	The telegram polarity of the 1-bit "Valve closed" communication object can be set here. This parameter is only visible if the status object "Valve closed" is enabled.
Alarm object for overload / short-circuit	disabled Enabled	The device monitors the valve output for short-circuits and overloads as soon as the output is switched on and energised. Short-circuit and overload detection is always active. Optionally, a 1-bit alarm object can be enabled here, allowing the signalling of fault operation due to a short-circuit or overload in the bus.
Polarity of "Short-circuit / overload alarm" object	Object value on overload / short-circuit = 0 Object value on overload / short-circuit = 1	The telegram polarity of the 1-bit "Short-circuit / overload alarm" object can be set here. This parameter is only visible when the short-circuit / overload message is enabled.

5 Appendix

5.1 Index

A		T	
Anti-sticking protection.....	36	Telegram rate limit.....	22
application program.....	16		
B		U	
bus voltage failure.....	36	Unloading the application program.....	16
bus voltage return.....	37		
C		V	
Command value evaluation.....	40	Value transmitter function.....	27
Command value limit.....	49	Valve direction of action.....	31
command value monitoring.....	47	Venetian blind function.....	25
Commissioning.....	10		
communication objects.....	17		
cycle time.....	45		
D			
Delay after bus voltage return.....	22-23		
Delivery state.....	59		
Device components.....	5		
Dimming function.....	24		
disabling function.....	30		
E			
ETS programming.....	38		
ETS search paths.....	13		
F			
Forced position function.....	33		
L			
limit values.....	50		
M			
Maximum command value.....	50		
Minimum command value.....	50		
O			
Operating switchover.....	34		
P			
priority.....	58		
Pulse width modulation.....	41		
S			
Safe-state mode.....	16		
Status message.....	52-53		
Switching function.....	24		