

Smart Control 10, 15, 19

Ref.-no.: SC 10.1
SC 15.1
SC 19.1

ALBRECHT JUNG GMBH & CO. KG
Volmestraße 1
58579 Schalksmühle
GERMANY

Tel. +49 2355 806-0
Fax +49 2355 806-204

kundencenter@jung.de
www.jung.de

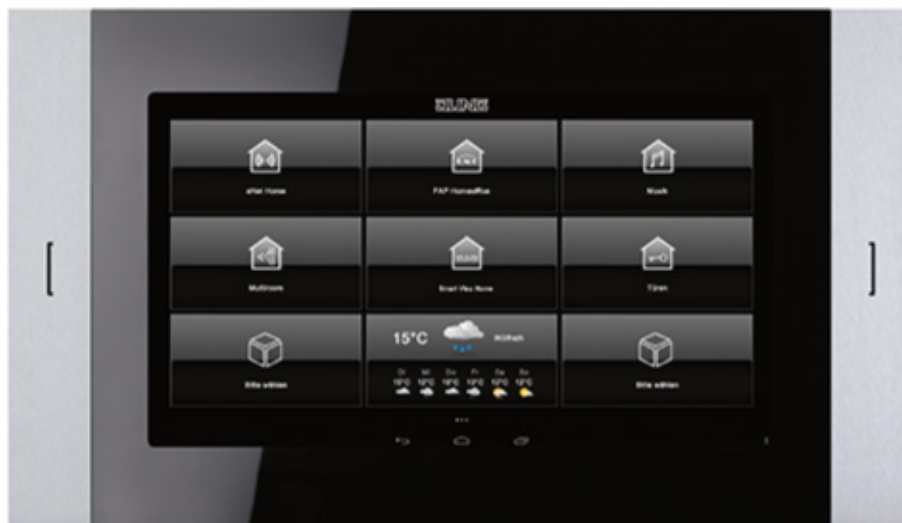

Product documentation



Table of contents

1	Installation and commissioning	4
1.1	Safety instructions and structure of the device	4
1.1.1	Safety instructions	4
1.1.2	Structure of the device	4
1.2	Function	4
1.2.1	Intended purpose	4
1.2.2	Product characteristics	4
1.3	Installation	5
1.3.1	Information for electrically skilled persons	5
1.3.2	Installation and electrical connection	5
1.4	Commissioning	6
1.4.1	Settings – Menu overview	6
1.4.2	Opening the settings menu	6
1.4.3	Changing the default language	6
1.4.4	Selecting the current date and time	7
1.4.5	Changing the default password	7
1.4.6	Creating app shortcut in main menu	8
1.4.7	Updating the firmware	8
2	Connections, operating controls and indicator lights	9
2.1	Operating controls device front side	9
2.2	Connections device rear side	9
3	Operation and configuration	10
3.1	Device settings	10
3.1.1	Settings – Menu overview	10
3.1.2	Menu area “General / Design settings”	10
	Checking network settings and activating/deactivating network connection	10
	Selecting city for weather report and activating/deactivating weather report	11
	Selecting colour and alignment for menu design, selecting extended menu design	11
	Setting time for sidepanel and activating/deactivating sidepanel	12
	Hiding/showing navigation bar	12
	Hiding/showing button description	13
	Selecting number of pages for the main menu	13
	Activating/deactivating press and hold function	14
3.1.3	Menu area „Power / Lock screen settings“	14
	Setting display brightness	14
	Setting brightness range for brightness sensor	15
	Setting wake-up behaviour for proximity sensor	15
	Setting detection range for proximity sensor	16
	Selecting and setting lock screen	16
3.1.4	Menu area „System / Access settings“	17
	Selecting app for automatic startup	17
3.2	Operation via apps in the main menu	18
3.3	Apps for building automation	18

3.4 App configuration	19
3.4.1 App "JUNG Abfallkalender"	19
Setting scheduled garbage disposals	19
Changing scheduled garbage disposals	20
3.4.2 App "System Update"	21
Restoring default settings	21
Updating the firmware without internet connection	21
3.5 Installation of extra apps from app store	22
4 Cleaning	23
5 Technical data	23
6 Accessories	23
7 Warranty	23

1 Installation and commissioning

1.1 Safety instructions and structure of the device

1.1.1 Safety instructions



Electrical devices may only be mounted and connected by electrically skilled persons.

Serious injuries, fire or property damage possible. Please read and follow manual fully.
Danger of electric shock. Always disconnect before carrying out work on the device or load.
These instructions are an integral part of the product, and must remain with the end customer.

1.1.2 Structure of the device

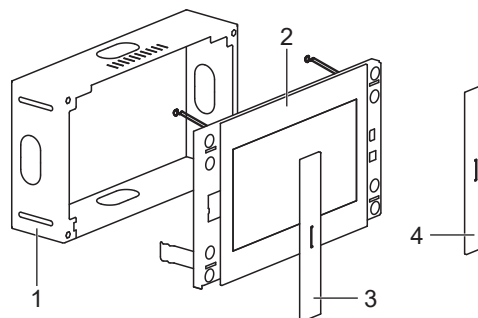

Fig. 1: Structure of the device

	Component
1	Flush-mounted recessed box
2	Smart Control
3	Design cover left
4	Design cover right

1.2 Function

1.2.1 Intended purpose

- Operation and visualisation of system statuses and information on building automation
- for installation in walls

1.2.2 Product characteristics

- High performance HD screen
- Proximity sensor
- Ambient light sensor
- Door call function only in combination with Siedle Smart Gateway SG 650-.. or SG 150-..
- KNX visualisation in combination with Visu Pro Server (ref.-no.: JVP-SERVER-H..)
- KNX visualization in combination with Smart Visu Server (ref.-no.: SV-SERVER-INT)
- Pre-installed iHaus-Server-App; iHaus-KNX connection via IP router (ref.-no.: IPR 200 REG, IPR 300 SREG) or IP interface (ref.-no.: IPS 200 REG, IPS 300 SREG)
- Pre-installed weather page
- Display of up to six IP camera images
- Cleaning function
- Capacitive touchscreen
- Fanless, without rotating parts
- Graphical user interface

1.3 Installation

1.3.1 Information for electrically skilled persons



DANGER

Electric shock from touching live parts in the installation environment.
An electric shock can be fatal.

Before working on the device, disconnect the power and cover live parts in the area.

1.3.2 Installation and electrical connection

Depending on the Smart Control dimensions it must be installed in various flush-mounted recessed boxes:

SC 10.1	SC 10 EBG
SC 15.1	SC 15 EBG
SC 19.1	SC 19 EBG

Ensure horizontal orientation when installing the flush-mounted box:

The flush-mounted box must be exactly orientated in the wall.

- Connect LAN (PoE+).
- Connect optional power supply.
Only SC 19.1: Always connect power supply, no Power over Ethernet possible.
- Place Smart Control in flush-mounted box.
Slightly push down both holding clamps on the upper side of Smart Control to place it in flush-mounted box.
- Tighten all four locking screws (5) under left design cover and right design cover. (fig. 2)

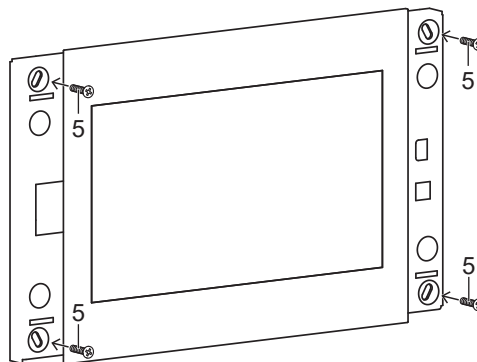

Fig. 2: Locking screws under design covers

- Attach both design covers.

1.4 Commissioning

After connecting the device you must change the default settings for commissioning your device.

1.4.1 Settings – Menu overview

- General / Design settings
 - Select language
 - Set time / date
- Power / Lock screen settings
- System / Access settings
 - Password protection

1.4.2 Opening the settings menu

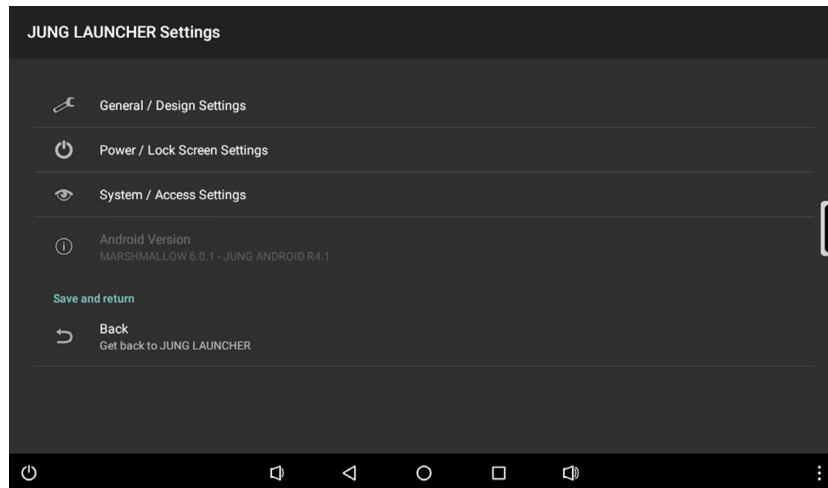

Fig. 3: Settings

- Select JUNG-logo in main menu (JUNG Launcher).
Password input opens.
- Enter password.
The default password is "0000".
Settings menu opens.

1.4.3 Changing the default language



Fig. 4: General / Design settings – Select language

i The default language is English.

- Open settings menu.
- Select menu "General / Design settings".
- Select submenu "Select language".
- Select "Select language".
Available languages are shown.
- Select language.
Default language is changed.

1.4.4 Selecting the current date and time

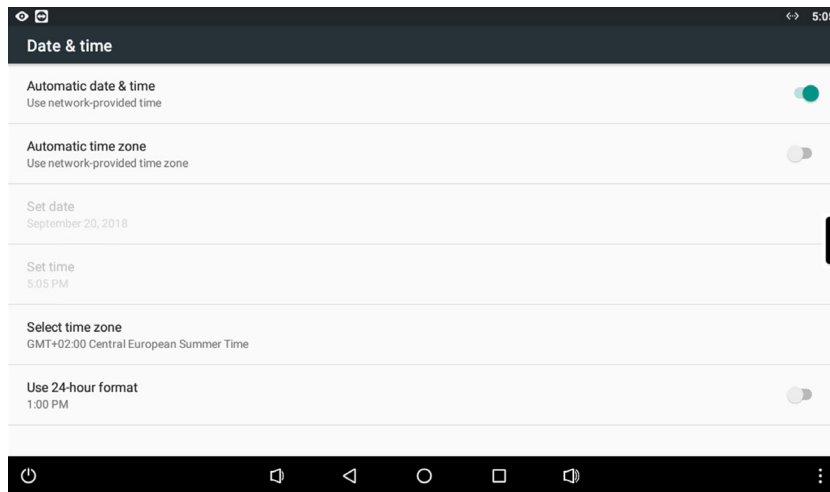

Fig. 5: General / Design settings – Set date / time

- Open settings menu.
- Select menu “General / Design settings”.
- Select submenu “Set date / time”.
- Change settings:
 - autom. date & time: activated (date and time are applied by selected timezone)
 - autom. time zone: deactivated (device does not detect location, timezone must be selected manually)
 - Select time zone (e.g. GMT+2)
 - 24-hour format: activated

1.4.5 Changing the default password

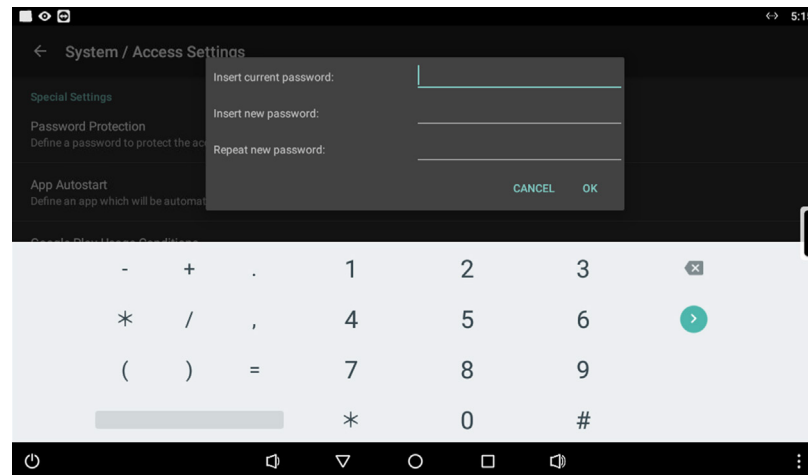

Fig. 6: System / Access settings – Password protection

- Open settings menu.
- Select menu “System / Access settings”.
- Select submenu “Password protection”.
- Password input opens.
- Enter current and new password.
- Confirm passwords with “OK”.
- Default password is changed.

1.4.6 Creating app shortcut in main menu

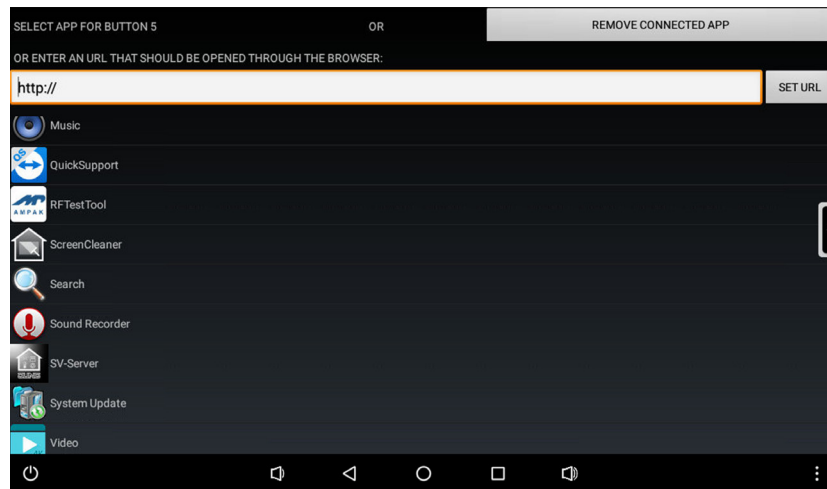

Fig. 7: App shortcut

- Touch and hold area/tile in main menu.
Google Play request opens.
- Cancel request.
App list is shown.
- Select app.
Request about symbol and name opens.
- Change symbol and name or use default settings.
App shortcut is shown in main menu.

1.4.7 Updating the firmware

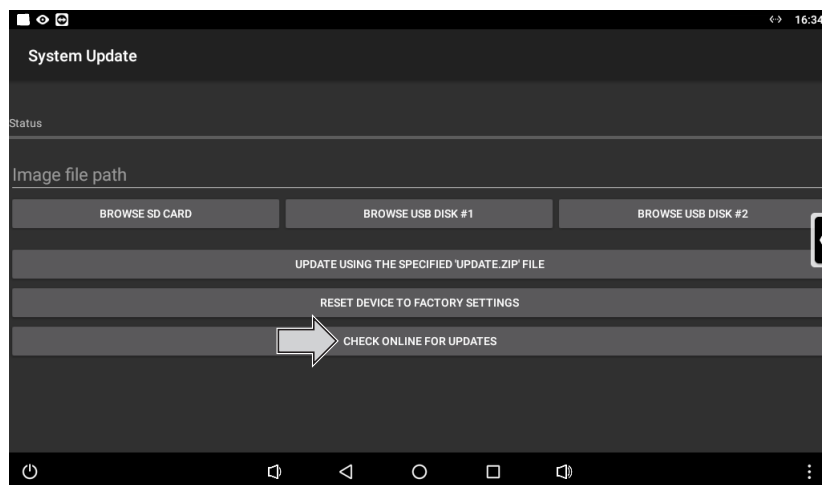

Fig. 8: System Update – Update firmware via internet connection

Requirements:

- Internet connection
- App “System Update” in main menu
- Select app “System Update”.
App starts.
- Select „Check online for updates”.
Firmware is updating automatically.

2 Connections, operating controls and indicator lights

2.1 Operating controls device front side

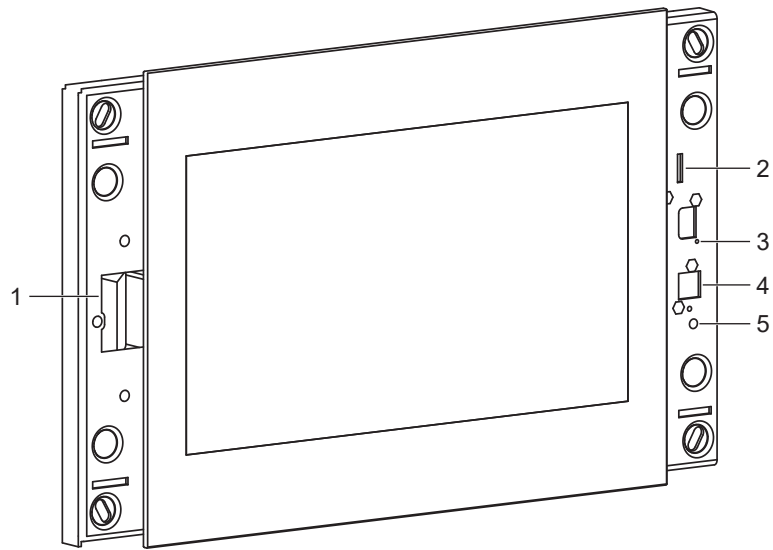

Fig. 9: Operating controls device front side

	Name	Function
1	Speaker	for playing signal tones
2	SDHC card reader	for reading memory cards
3	Microphone	for door communication
4	Home button	to get back to main menu
5	Reset button	for restarting the device

2.2 Connections device rear side

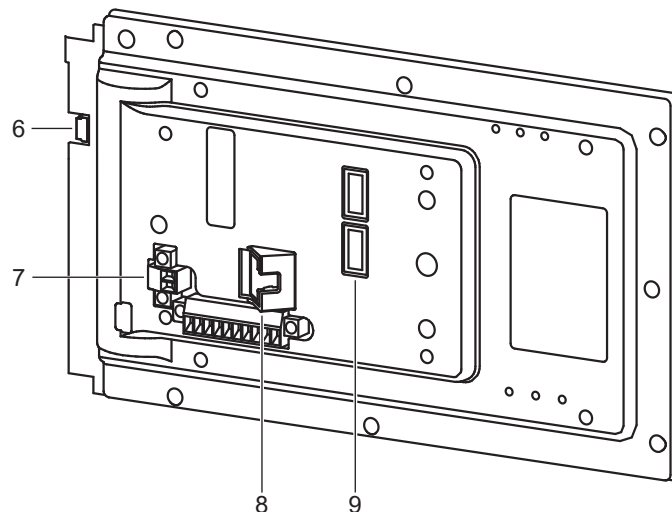

Fig. 10: Connections device rear side

	Name	Function
6	USB OTG Mini	USB connection for maintenance work
7	DC 12 ... 32 V	connection for optional external power supply
8	LAN (PoE+)	network connection and power supply
9	USB 2.0 (2 x)	connection for USB devices

3 Operation and configuration

3.1 Device settings

Besides the settings for commissioning settings for the device can be made. The device settings are called up via the JUNG Launcher in the main menu.

See “Opening the settings menu“ in the chapter commissioning.

3.1.1 Settings – Menu overview

- General / Design settings
 - Network configuration
 - Enable weather report
 - Select city
 - Select design
 - Enable side panel
 - Auto-close side panel
 - Show navigation bar
 - Empty button description
 - Set page amount
 - Long click function
- Power / Lock screen settings
 - Display brightness
 - Brightness sensor
 - Proximity sensor
 - Lock screen
- System / Access settings
 - App autostart

3.1.2 Menu area “General / Design settings”

Checking network settings and activating/deactivating network connection

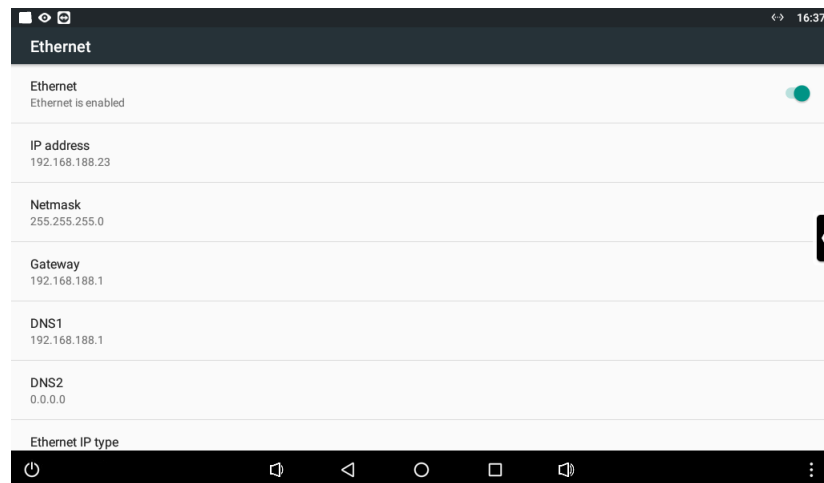

Fig. 11: General / Design settings – Network configuration

- Open settings menu.
- Select menu “General / Design settings“.
- Select submenu “Network configuration“.

Network settings are shown.

The network settings are managed by other devices in the network. The settings can't be changed here. The network connection can be activated/deactivated with the slider.

Selecting city for weather report and activating/deactivating weather report

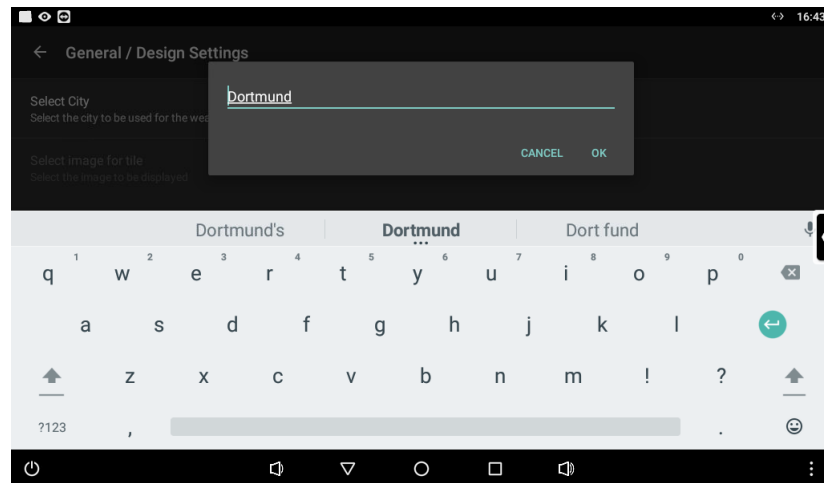

Fig. 12: General / Design settings – Select city

- Open settings menu.
- Select menu “General / Design settings”.
- Select submenu “Select city”.
Input window opens.
- Enter city name.
- Confirm input with “OK”.
City for weather report is selected.
The weather report can be activated/deactivated with the checkbox in the menu “General / Design settings”.
If the weather report is deactivated, an image can be selected here. The selected image is shown in the main menu instead of the weather report.

Selecting colour and alignment for menu design, selecting extended menu design

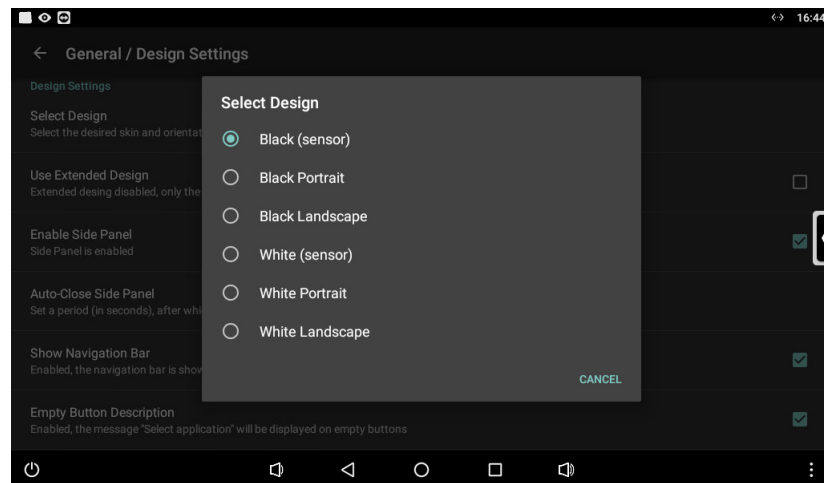

Fig. 13: General / Design settings – Select design

- Open settings menu.
- Select menu “General / Design settings”.
- Select submenu “Select design”.
Selection window opens.
- Select design.
The position sensor in the device can automatically align the menus horizontally (landscape) or vertically (portrait).
Selected design is applied
The extended design can be activated/deactivated with the checkbox in the menu “General / Design settings”.
If the extended design is deactivated, only tiles are shown in the main menu.

Setting time for sidepanel and activating/deactivating sidepanel

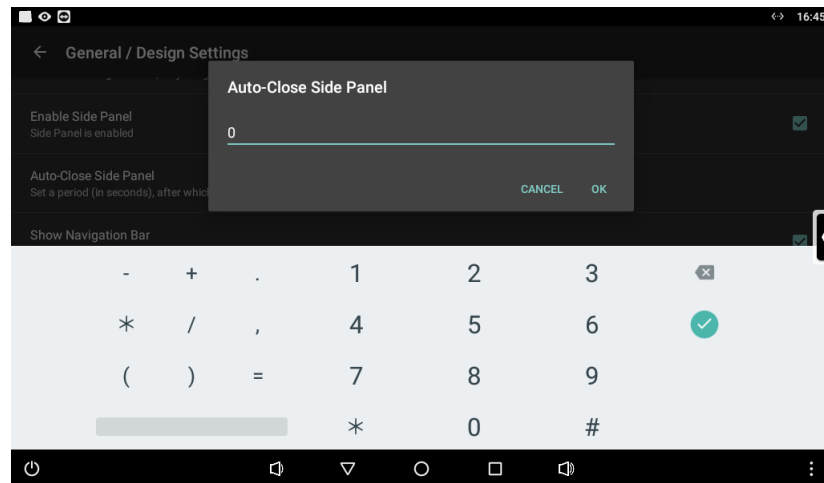

Fig. 14: General / Design settings – Auto-close side panel

- Open settings menu.
- Select menu “General / Design settings”.
- Select submenu “Auto-close side panel”.
Input window opens.
- Enter time.
- Confirm input with “OK”.
Time for automatic closing of sidepanel is set.
The sidepanel can be activated/deactivated with the checkbox in the menu “General / Design settings”.
If the sidepanel is deactivated, it can't be shown.

Hiding/showing navigation bar

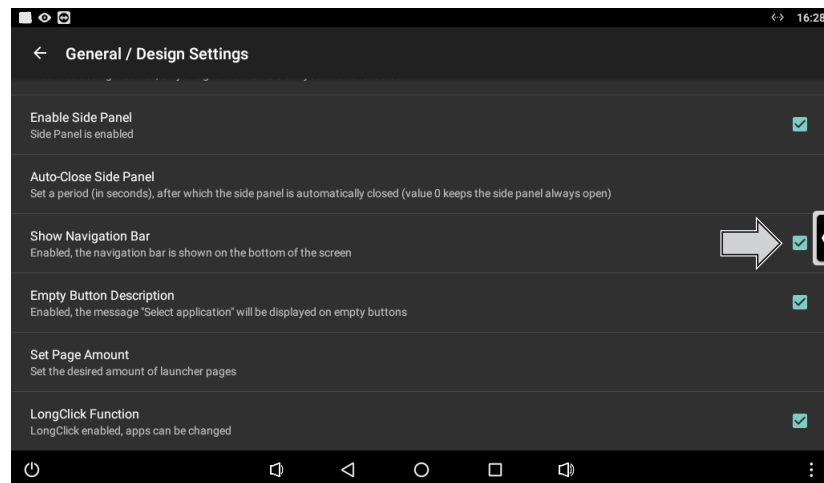

Fig. 15: General / Design settings – Show navigation bar

- Open settings menu.
- Select menu “General / Design settings”.
- Check/uncheck “Show navigation bar” with the checkbox.
Navigation bar in the lower area of the screen is shown/hidden.

Hiding/showing button description

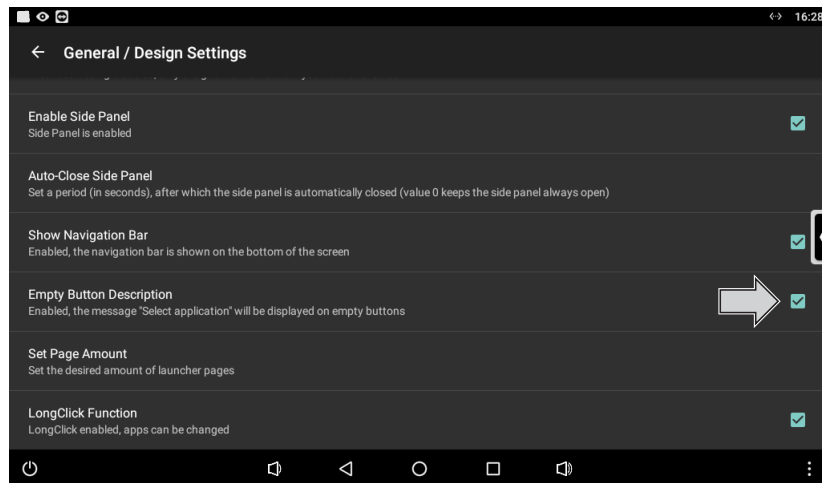

Fig. 16: General / Design settings – Empty button description

- Open settings menu.
- Select menu “General / Design settings”.
- Check/uncheck “Empty button description” with the checkbox.
Description <Select application> on empty tiles in the main menu is shown/hidden.

Selecting number of pages for the main menu

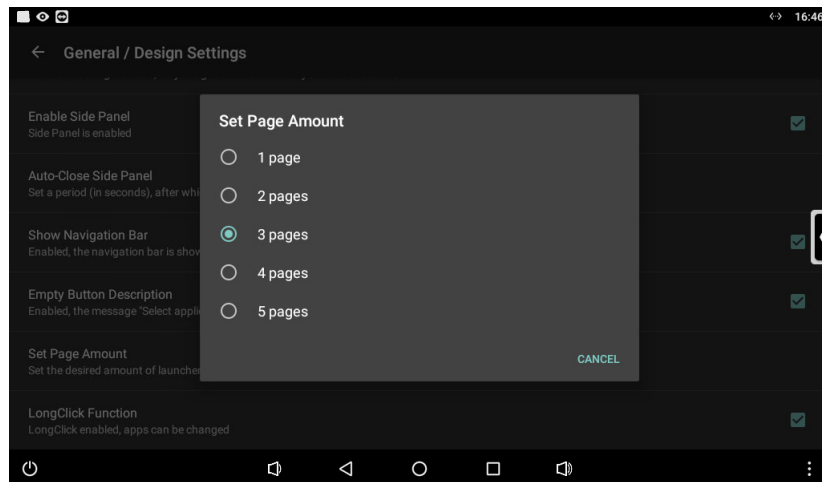

Fig. 17: General / Design settings – Set page amount

- Open settings menu.
- Select menu “General / Design settings”.
- Select submenu “Set page amount”.
Selection window opens.
- Select number of pages for main menu.
Number of pages in the main menu is adjusted.

Activating/deactivating press and hold function

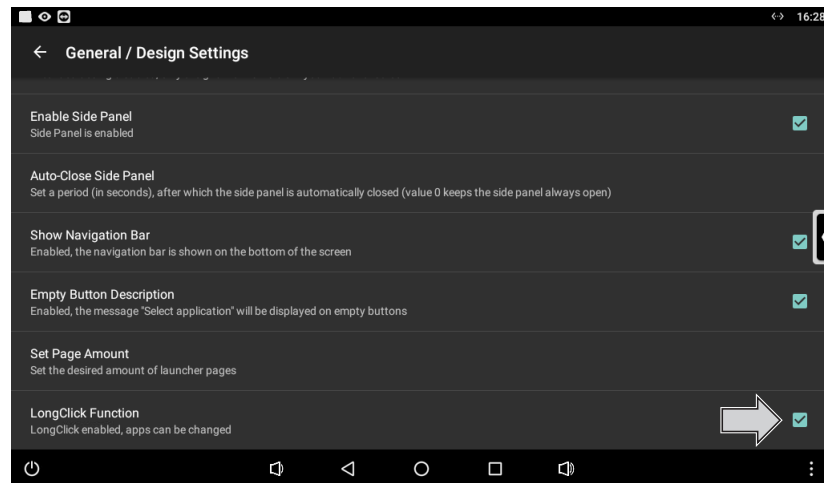

Fig. 18: General / Design settings – Long click function

- Open settings menu.
- Select menu “General / Design settings“.
- Check/uncheck “Long click function“ with the checkbox.
Press and hold function is activated/deactivated.
If the press and hold function is deactivated, app shortcuts in the main menu can't be created and existing app shortcuts can't be changed.

3.1.3 Menu area „Power / Lock screen settings“

Setting display brightness

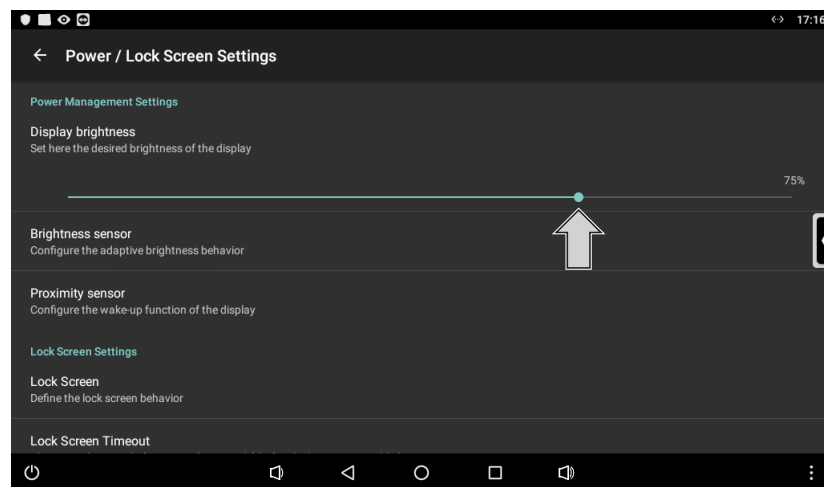

Fig. 19: Power / Lock screen settings – Display brightness

- Open settings menu.
- Select menu “Power / Lock screen settings“.
- Adjust display brightness with the slider.
Display brightness is adjusted.

Setting brightness range for brightness sensor

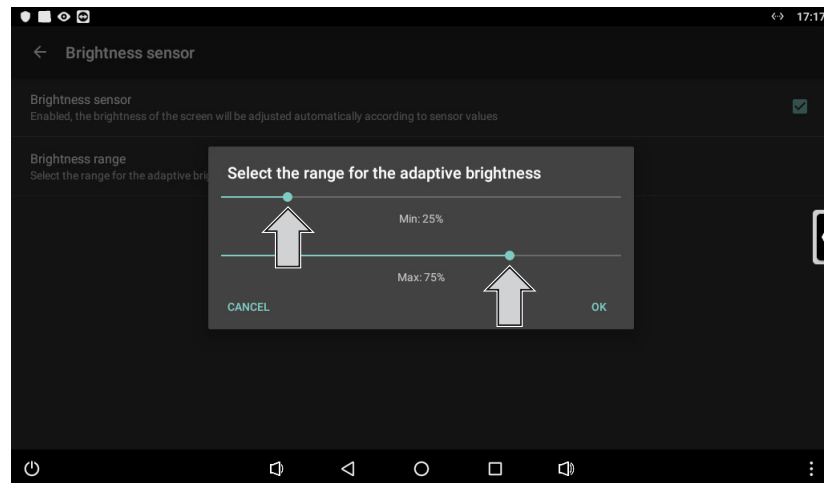

Fig. 20: Power / Lock screen settings – Brightness sensor – Brightness range

- Open settings menu.
- Select menu “Power / Lock screen settings“.
- Select submenu “Brightness sensor“.
- If necessary activate “Brightness sensor“ with the checkbox.
- Select submenu “Brightness range“.
- Settings window opens.
- Adjust brightness range with the slider.
- Confirm settings with “OK“.
- Brightness range is set.

Setting wake-up behaviour for proximity sensor

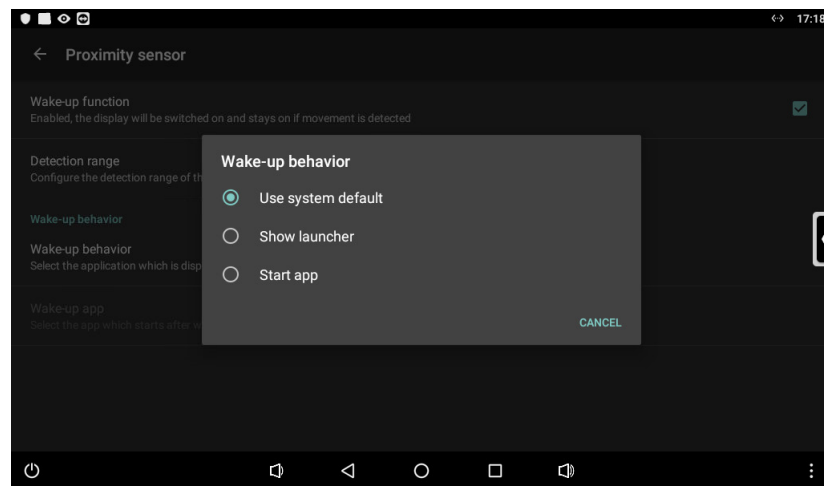

Fig. 21: Power / Lock screen settings – Proximity sensor – Wake-up behaviour

- Open settings menu.
- Select menu “Power / Lock screen settings“.
- Select submenu “Proximity sensor“.
- The submenu “Proximity sensor“ can only be selected, if the lock screen “Display off“ is selected. See chapter “Selecting and setting lock screen“.
- If necessary activate “Wake-up function“ with the checkbox.
- Select submenu “Wake-up behaviour“.
- Selection window opens.
- Select wake-up behaviour.
- Wake-up behaviour is adjusted.

Setting detection range for proximity sensor

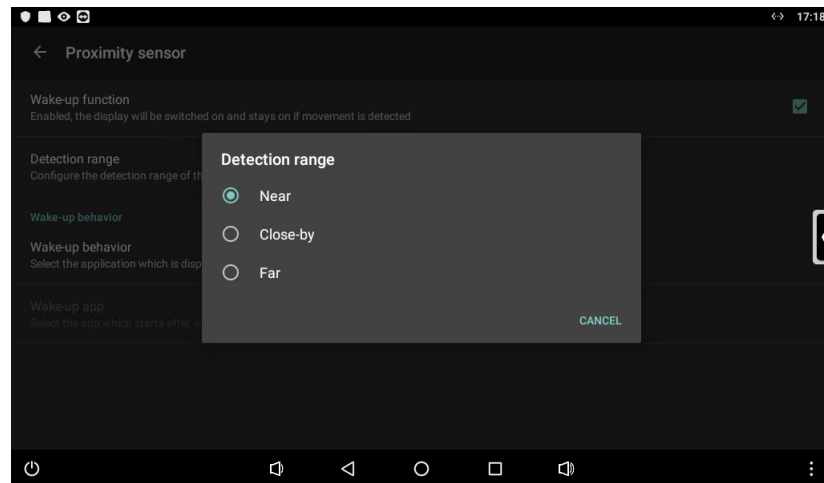

Fig. 22: Power / Lock screen settings – Proximity sensor – Detection range

- Open settings menu.
- Select menu "Power / Lock screen settings".
- Select submenu "Proximity sensor".
The submenu "Proximity sensor" can only be selected, if the lock screen "Display off" is selected. See chapter "Selecting and setting lock screen".
- Select submenu "Detection range".
Selection window opens.
- Select detection range.
Detection range is set.

Selecting and setting lock screen

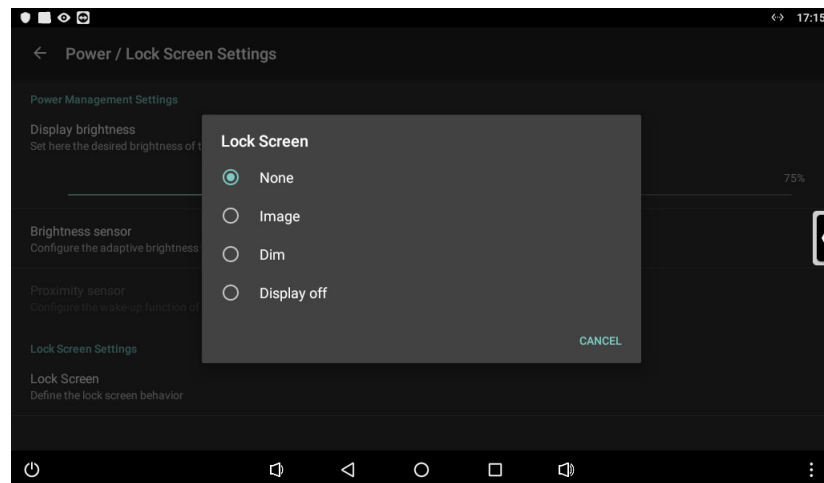

Fig. 23: Power / Lock screen settings – Lock screen

- Open settings menu.
- Select menu "Power / Lock screen settings".
- Select submenu "Lock screen".
Selection window opens.
- Select or deactivate lock screen.
Selected lock screen is applied.
Depending on the selected lock screen the following extra settings can be made:
 - Time for lock screen
Recommendation: If password or app "Door communication" is used, at least set time to 60 seconds.
 - Image instead of lock screen
 - Clock in lock screen
 - Password for lock screen

3.1.4 Menu area „System / Access settings“

Selecting app for automatic startup

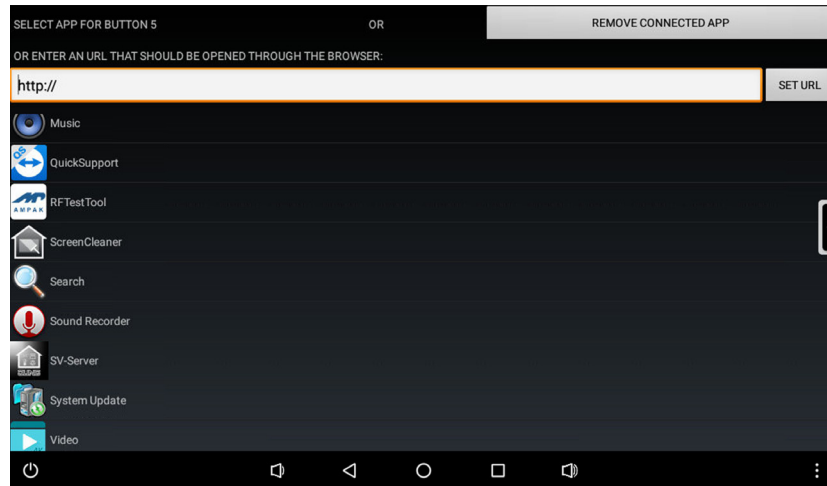

Fig. 24: System / Access settings – App autostart

- Open settings menu.
- Select menu “System / Access settings“.
- Select submenu “App autostart“.
App list is shown.
- Select app.
App will be started automatically after every reboot of the device.

3.2 Operation via apps in the main menu

The device is operated by preinstalled apps.
The apps must be started via main menu.



Fig. 25: Main menu (JUNG Launcher)

3.3 Apps for building automation

Software applications for building automation are already preinstalled on the device.
Depending on the used system, only specific apps can be used.
The apps are for the visualization of system statuses and for the controlling of single components.

Examples for preinstalled apps for building automation:

- JUNG Visu Pro
- JUNG Smart Visu Server
- JUNG Kamera
- JUNG Facility Pilot
- Door communication
- eNet Smart Home
- iHaus

i Before using apps, app shortcuts must be created in the main menu.
See "Creating app shortcut in main menu" in chapter commissioning.

These apps are just working with additional hardware and software. Components from third party suppliers could also be required.

For more information about apps see the product documentation of the specific device. The product documentation can be downloaded from our website.

3.4 App configuration

- i** Before using apps, app shortcuts must be created in the main menu.
See “Creating app shortcut in main menu” in chapter commissioning.

3.4.1 App “JUNG Abfallkalender“

Setting scheduled garbage disposals



Fig. 26: JUNG Abfallkalender – Empty list for scheduled garbage disposals

- Select app “JUNG Abfallkalender“ in the main menu.
App starts.
Empty list for scheduled garbage disposals is shown.
- Select plus button for scheduling new garbage disposals.
Settings for scheduling new garbage disposals are shown.

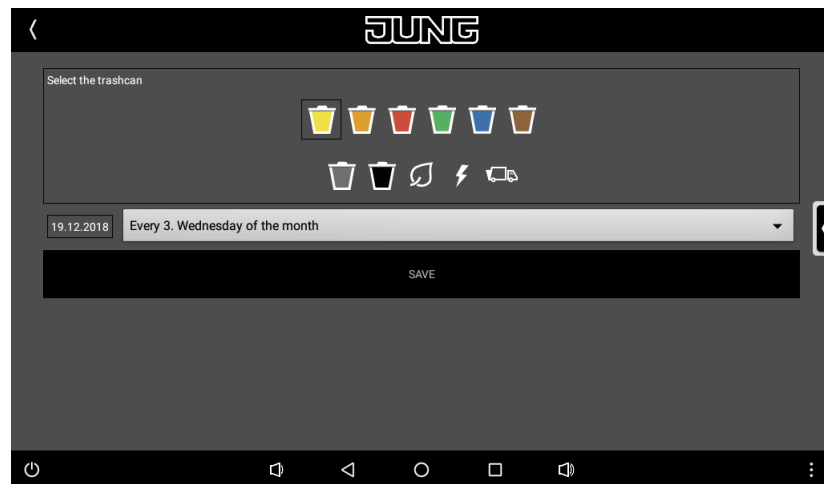

Fig. 27: JUNG Abfallkalender – Settings for scheduling new garbage disposals

- The following settings can be made:
 - Symbol for trashcan
 - Date for first scheduled garbage disposal
 - Time interval between scheduled garbage disposals
- Confirm settings with button “Save”.
Settings are applied.
Scheduled garbage disposal is added to list for scheduled garbage disposals and list is shown.

Changing scheduled garbage disposals

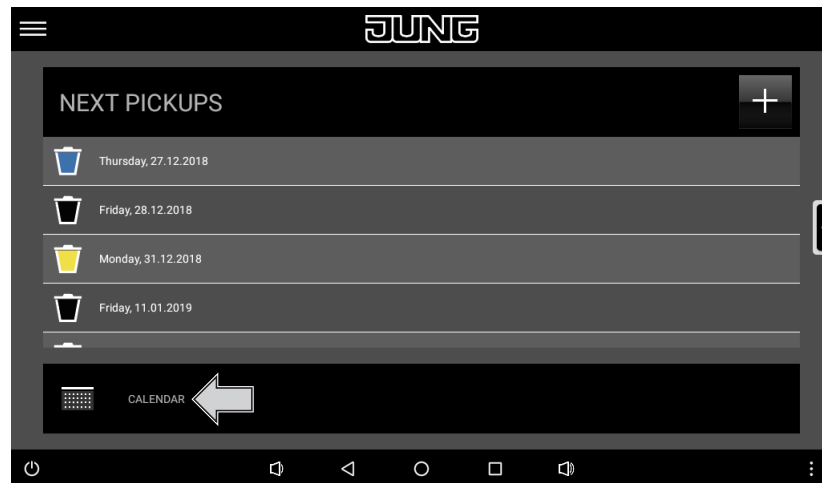

Fig. 28: JUNG Abfallkalender – List with scheduled garbage disposals

- Select app “JUNG Abfallkalender“ in the main menu.
App starts.
List with scheduled garbage disposals is shown.
- Select “Calendar“.
Calendar with scheduled garbage disposals is shown.



Fig. 29: JUNG Abfallkalender – Calendar with scheduled garbage disposals

- Select a day with scheduled garbage disposal in the calendar.
Settings for scheduled garbage disposals are shown.
- Change settings for scheduled garbage disposals.
See “Setting scheduled garbage disposals“ in the previous chapter.

3.4.2 App “System Update“

Restoring default settings

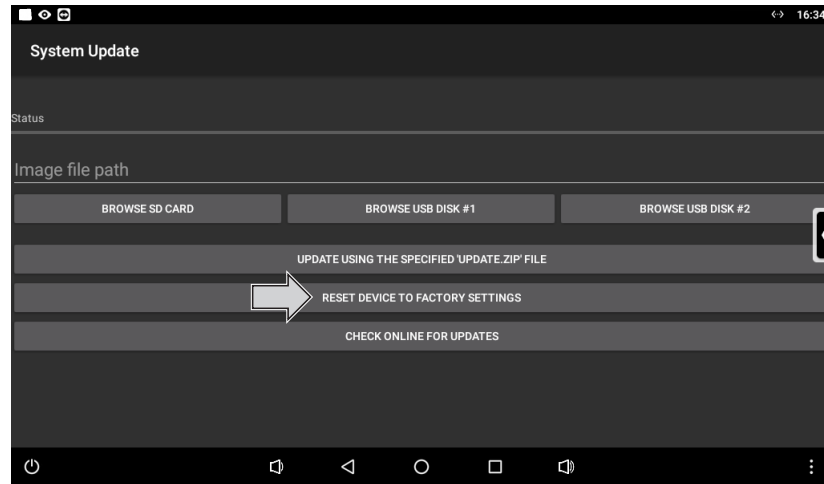

Fig. 30: System Update – Restore default settings

- Select app “System Update“ in the main menu.
App starts.
- Select “Reset device to factory settings“.
Request about restoring the default settings opens.
- Confirm restoring with button “OK“.
Default settings are restored.

Updating the firmware without internet connection

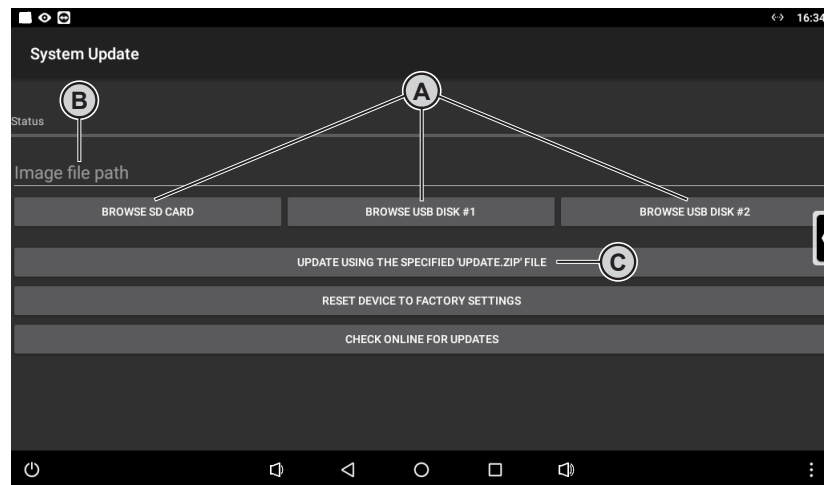

Fig. 31: System Update – Update firmware without internet connection

i Check firmware version in “Settings” menu.

Requirements:

- SD card or USB data storage with FAT32 file system
- Data files for update on SD card or on USB data storage device
- SD card in card slot or USB data storage device in USB connection
- Select app “System Update“ in the main menu.
App starts.
- Select “Browse SD card“ or “Browse USB disc #1 or #2“ (A)
Data files are shown.
- Select update file in zip format.
Path to the update file is applied (B).
- Select “Update using the specified ‘update.zip’ file“ (C).
Firmware is updating.

3.5 Installation of extra apps from app store

The app store of Google can be activated on the device.

Numerous apps of different manufacturers can be purchased via the app store.

Only install apps which are not influencing the basic functionality of the device.

Also take care that the device stays secure by using the app store. JUNG cannot guarantee that external apps are working on the device. A non-functional app from a third party is no reason for any complaint.

Details on the first steps with the Google app store can be found on the following web page:

<http://support.google.com/googleplay/?hl=de>

Details about using the Goggle app store:

- Internet connection:
The app store requires an active internet connection. If the device is used without internet access, the app store is either automatically hidden or shows a corresponding warning message.
 - Time and date settings:
In order to be able to use the app store, you have to check that your device shows the correct time and date settings. If these settings are not correct, the app store cannot connect to its servers and will show no contents. The time/date settings can be configured through the settings page of the JUNG Launcher.
(General / Design settings – Set time / date)
 - Cache of the app store:
If no app download is possible, please empty the cache of the app store through the settings of the JUNG Launcher. (System / Access settings – Manage applications – All – Google app store)
 - Apps not shown:
Please note that you will not be able to install all apps from the app store on your device. The app store is filtering apps according to certain criteria (for example display size, permissions, additional functions like position sensor, GPS, phone etc.). If the device doesn't support a required criterion, the app will not be shown in app store. So if you shouldn't be able to see an app on your device that is visualised on your smartphone normally, it could be one of that not fulfilled criteria required by the app to be launched correctly. In this case you can try to get in contact with the manufacturer of the app in order to understand the missing criteria and eventually find a solution for being able to run the app on your device.
- i** The app store can only be used with a valid Google account. If needed, this account can be created directly on your device using the wizard within the app store.

4 Cleaning

 The cleaning mode must be started with „Screencleaner“ app.

Suitable detergents:

Water, degreaser, glass cleaner, alcohol and isopropyl

Not suitable detergents:

Abrasive wipes or aggressive detergents

- Start cleaning mode or switch off device to lock touchscreen.
- Apply detergent or water on a cleaning wipe.
Don't apply it directly on device.
- Clean front side with wipe.
Detergent is not allowed to get into the device while cleaning.
- Switch on device after cleaning it or wait until automatic end of cleaning mode after 30 seconds.

5 Technical data

Screen diagonal

SC 10.1	256 mm / 10.1"
SC 15.1	396 mm / 15.6"
SC 19.1	470 mm / 18.5"

Resolution

SC 10.1	1024 x 600 WSVGA
SC 15.1, 19.1	1366 x 768 WXGA

Frame dimensions (W x H)

SC 10.1	333 x 200 mm
SC 15.1	510 x 306 mm
SC 19.1	600 x 345 mm

Power consumption

SC 10.1	max. 16 W
SC 15.1	max. 25 W
SC 19.1	max. 30 W

Power supply

SC 10.1, 15.1	Power over Ethernet Plus (PoE+) acc. to IEEE 802.3at or DC 12 ... 32 V via external power supply
SC 19.1	DC 12 ... 32 V via external power supply

Aspect ratio 16:9

Operating system Android 6

Processor Cortex-A53

Main memory 2 GB

Mass storage 16 GB Flash

Ambient temperature 0 ... +30 °C

6 Accessories

Power supply NT 2415 REG VDC

Flush-mounted recessed boxes

SC 10.1	SC 10 EBG
SC 15.1	SC 15 EBG
SC 19.1	SC 19 EBG

7 Warranty

The warranty follows about the specialty store in between the legal framework as provided for by law.