

Universal automatic switch 2.2 m  
Art. No. : ..3281-1..  
Standard automatic switch 2.2 m  
Art. No. : ..3281..

## Operating instructions

### 1 Safety instructions



**Electrical devices may only be mounted and connected by electrically skilled persons.**

**Serious injuries, fire or property damage possible. Please read and follow manual fully.**

**Do not press on the sensor window. Device can be damaged.**

**The device is not suitable for use as a burglar alarm or other alarm.**

**Caution. Damage to sensors may result due to high thermal radiation. Avoid direct sunlight penetration in the sensor window.**

**These instructions are an integral part of the product, and must remain with the end customer.**

## 2 Device components

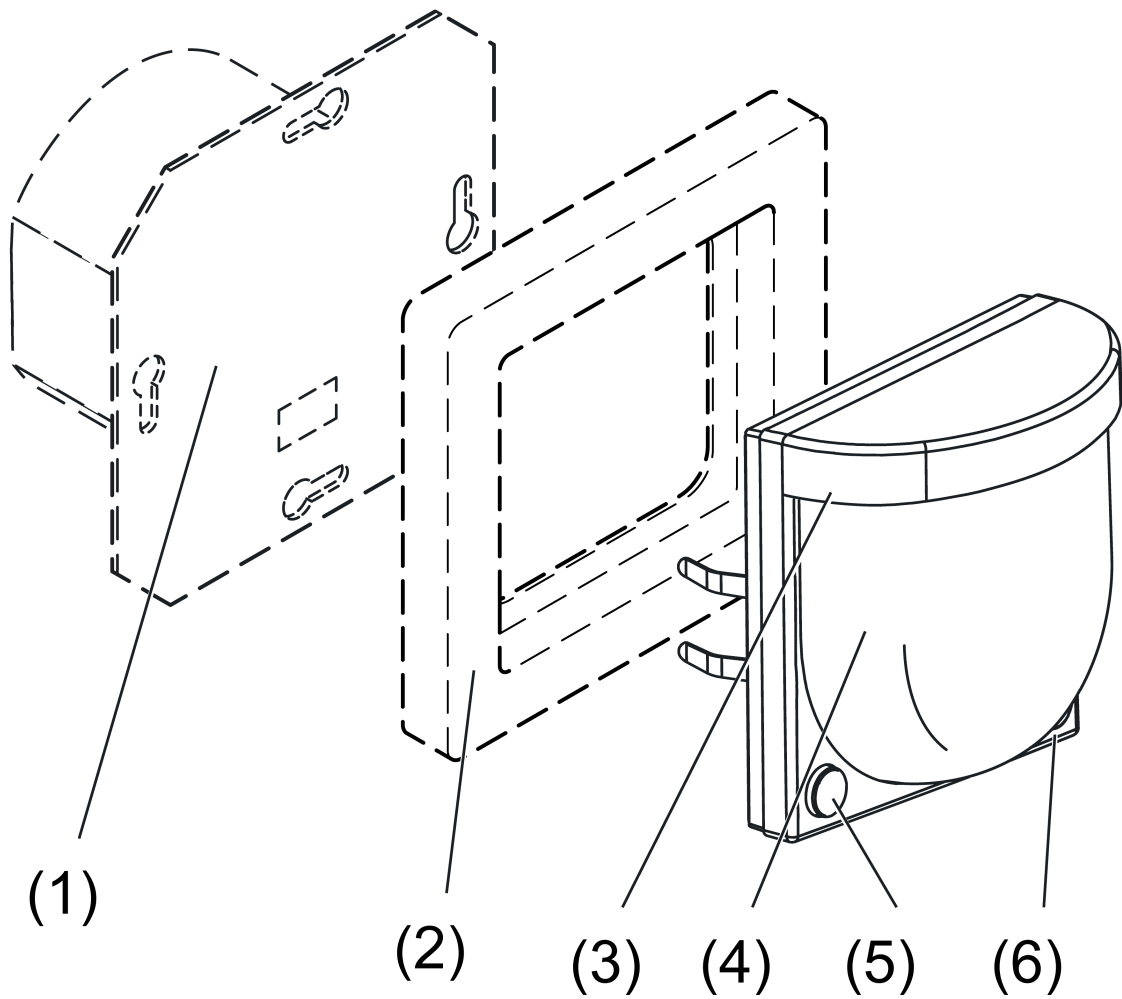

Figure 1: Device components

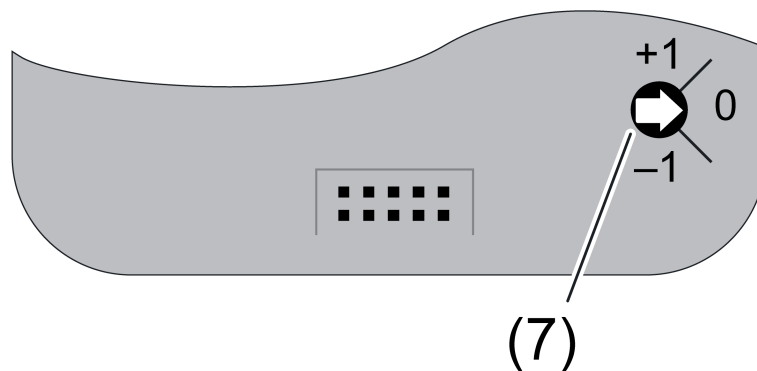

Figure 2: Adjuster **Sens.** (rear side)

- (1) Bus coupler 3 (accessory)
- (2) Frame
- (3) Motion detector
- (4) Sensor window

- (5) Button **O / AUTO**
- (6) Button **I / AUTO**
- (7) Adjuster **Sens.**

### 3 Function

#### System information

This device is a product of the KNX system and complies with the KNX directives. Detailed technical knowledge obtained in KNX training courses is a prerequisite to proper understanding.

The function of this device depends upon the software. Detailed information on loadable software and attainable functionality as well as the software itself can be obtained from the manufacturer's product database.

Planning, installation and commissioning of the device are carried out with the aid of KNX-certified software. Full functionality with KNX commissioning software version ETS4.2 and higher.

An updated version of the product database and technical descriptions are available on our Internet website.

#### Intended use

- Requirement-oriented control of lighting and other electrical consumers
- Mounting on bus coupler 3 (accessory)

 Recommendation: Use air-tight appliance boxes.

#### Product characteristics

- Automatic switching of light, depending on heat motion and ambient brightness
- 2 PIR sensors
- Detection area 180°
- Integrated brightness sensor
- Adjustable switch-off brightness
- Output functions: Switching, value transmitter, light scene extension, staircase function, switching with forced position, operating mode setting for room temperature controller
- Extension of the detection area by way of operating several devices as main unit or extension unit
- Adjuster for manual adjustment of sensitivity
- Status LED
- Manual switching on the device

Additional characteristics of "Universal" version:

- Manual operation with IR remote control possible (accessories)
- Detection field can be dimmed by 50% (parameter setting)
- 5 function blocks for motion detection each with 2 outputs
- Function blocks switchable, e.g. for day/night operation
- Brightness sensor function with 3 limiting values
- Alarm when unplugging from the bus coupler
- Temperature measurement

#### Motion detection function

The detection of movements is done through the "passive infrared" principle ("PIR"). The device generally reacts to heat radiation changes within its detection area. This is achieved with the help of the so-called PIR sensors, which are highly sensitive in the infrared range. The geometry of the detection field is ensured by a lens system that lets infrared light pass through and concentrates incident radiation on the sensors. So-called "detection radiation" are formed through the lens system and cause a clear signal jump to be detected when they enter.

Note: The term "detection radiation" refers to the imaginary line that begins in the sensor, goes through the lens system and continues in a straight line outside of the device. The device itself does not emit any radiation.

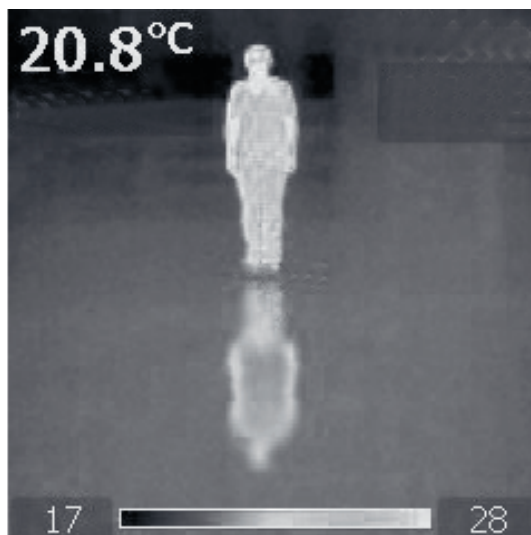

Figure 3: Thermal image of a person and their reflection on the ground

The detection of heat sources through a motion detector is influenced by the following criteria:

- Geometry of the detection field:  
A motion detector that faces downwards at an angle is different from one that looks straight ahead into infinity (figure 4).
- Distance between heat source and motion detector: the further away the heat source is from the sensor, the weaker the evaluable signal on the sensor (figure 4).
- Size of the heat source, e. g. adult or child (figure 5)
- Temperature of the heat source: surfaces at 37 °C radiate more intensely than at 10 °C (figure 5).
- Contrast between the heat source and the environment: if the heat source radiates just as intensely as the environment, detection will be significantly more difficult (figure 5).
- Speed of movement: a faster moving object produces clearer signals in the sensor.
- Direction of movement: if detection radiation passes tangentially, this typically results in an abrupt sensor signal which can be evaluated well. However, if a heat source moves radial to the sensor, the sensor signal changes happen more slowly. This makes differentiation from the background noise significantly more difficult.
- Concentration of the detection field: the number of sectors and switch segments of the detection field determines the concentration of the scan and therefore the response behaviour.
- Sensor sensitivity: the sensor sensitivity can be adjusted according to application and environment. Low heat contrasts outdoors may require a high sensitivity that is far too high for indoor use. The sensitivity should be decreased in this case.
- Environmental medium: high humidity or rain can negatively influence the permeability for infrared radiation.

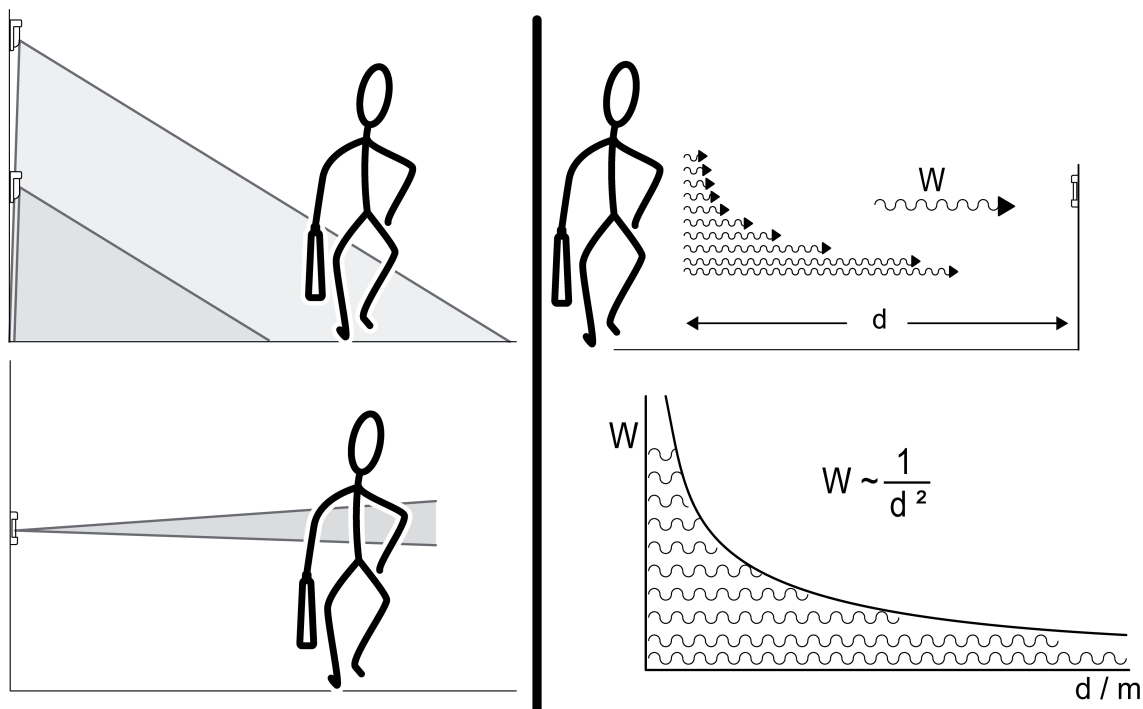

Figure 4: Detection of heat sources – detection field geometry and distance (photometric distance law)

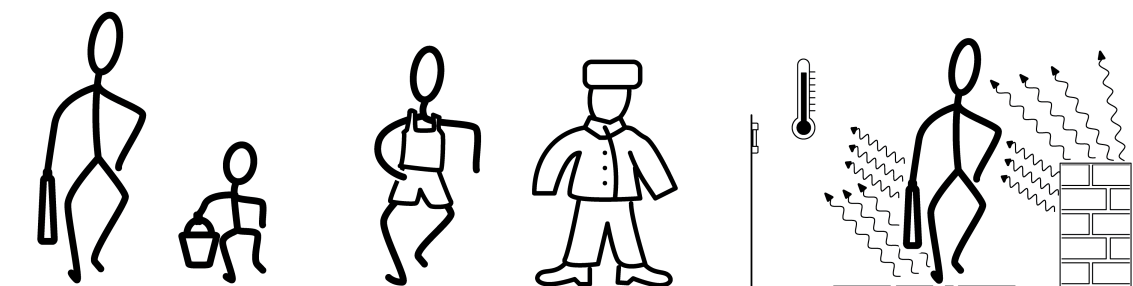

Figure 5: Size, insulation and contrast of heat sources

**Interference sources for motion detection**

In addition to the mentioned effects, other objects within the detection area could also trigger the motion detector, e.g.:

- Heat sources such as heating units, outlets from ventilation openings or air conditioners, copiers, printers, coffee machines, etc. (figure 6)
- Draughty doorways
- Incandescent lamps when switching on or off
- Animals, e.g. stray cats
- Reflections on reflecting surfaces (figure 3)

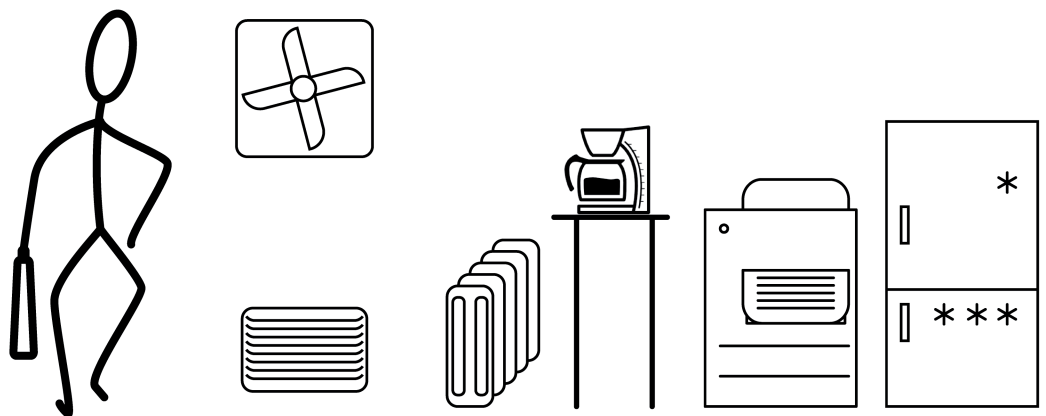

Figure 6: Heat sources in buildings

Some of the mentioned effects can be compensated for using intelligent filter switches by calibrating the received signals with typical motion patterns. Selecting the device and installation location should be made so that the detection field is suited for the intended purpose.

#### Technical information and statements

On the one hand the effective range of motion detector applications is affected by a wide range of factors – however, specifications in the technical data typically come out very precise. These specifications generally refer to the normal area of use of the device. For flush-mounted motion detector we assume the typical interior situation in a functional building with moderate ambient conditions, at a temperature of about 18 °C, average humidity, used in a hallway with walking people.

Higher ranges are to be expected for:

- lower ambient temperature (note season specific clothing)
- more intense movement of persons
- reflective surfaces

Lower ranges are to be expected for:

- higher ambient temperatures, where people move less and there is more heating, such as is the case with meeting rooms, classrooms, waiting areas and office environments
- significantly cooler ambient temperature, when clothing has a thicker insulating effect
- Direction of motion to the motion detector for ("radial detection")
- rising terrain that limits the geometry of the detection field.

## 4 Operation

### Switching the light on manually

- Press the **AUTO / I** button.

### Switching the light off manually

- Press the **O / AUTO** button.

### Switching on the Automatic operating mode

Prerequisite: The green or yellow LED lights.

**ON** or **OFF** operating mode is active.

- Press the **O / AUTO** or **AUTO / I** button.  
The LED goes out.

### Status LED

Behind the sensor window (4) there are status LEDs for indicating different states of operation (figure 7).

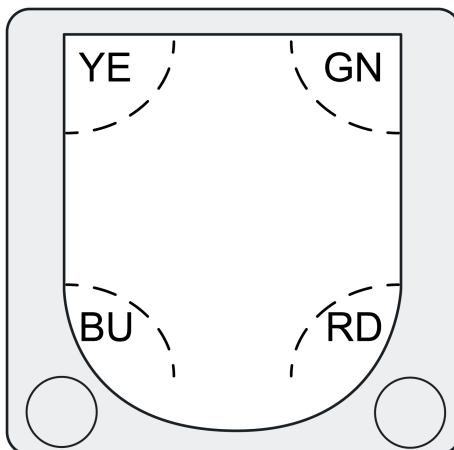



Figure 7: Status LED

- YE Yellow. **OFF** operating mode is active.
- GN Green. **ON** operating mode is active.
- BU Blue. Movement detected (parameter-dependent).  
or  
IR reception (oy for "Universal" version)
- RD Red. Programming mode is active.





### 5 IR remote control

Only for "Universal" version:

#### Function buttons IR remote control

Button	Function
ON 	Detection of a motion is sent for function block 1. The automatic mode is exited.
OFF 	End of a motion is sent for function block 1. The automatic mode is exited.
AUTO	The automatic mode is activated again for function block 1. The ON state is first exited after a new motion detection.

#### Adjustable buttons IR remote control

Button	Function
>	Increasing sensitivity
<	Reducing sensitivity
=	Resetting sensitivity to presetting
	Function block 1: Brightness threshold 10 lx
	Function block 1: Brightness threshold 50 lx
	Function block 1: Brightness threshold 150 lx
	Function block 1: Brightness independent operation
TEACH	Function block 1: Set current brightness as brightness threshold



<b>10 SEK, 30 SEK, 2 MIN, 5 MIN, 30 MIN</b>	Function block 1: Extend minimum run-on-time (10 seconds) by the selected value
<b>START, STOP</b>	Function block 1: Extend minimum run-on-time (10 seconds) individually

### Set-up buttons of IR remote control

Button	Function
<b>TEST</b>	Walking test – Check detection field
<b>RESET</b>	Reset sensitivity, brightness threshold and run-on-time to presetting. Press for at least 3 seconds

### Operation with IR remote control

If enabled, function block 1 can be operated manually by remote control. In manual operation, brightness and motion detection for function block 1 are switched off until automatic mode is reset.

- Switch on, e.g. light: Press the **ON**  button.
- Switch off, e.g. light: Press the **OFF**  button.
- Set automatic mode: Press the **AUTO** button.

### Manually changing settings with IR remote control



If enabled, individual settings for function block 1 can be changed during operation using a remote control.

Sensitivity:

- Increase sensitivity by one level: Press the **>** button.
- Decrease sensitivity by one level: Press the **<** button.
- Recall set sensitivity again: Press **=** button.

 The manual adjustment of sensitivity by the adjuster **Sens. (7)** is overwritten by the IR-remote control and vice versa.

Brightness threshold:

- Change brightness threshold: Depending on requirement, press **☾** button,  button,  button or  button.
- Set current brightness as brightness threshold: Press **TEACH** button.

Run-on-time: The preset run-on-time of 10 seconds can be extended individually.

- Extend run-on-time: Depending on requirement, press **10 SEK** button, **30 SEK** button, **2 MIN** button, **5 MIN** button or **30 MIN** button. Other values can be set with the **START/STOP** buttons.

## 6 Information for electrically skilled persons



**DANGER!**

**Mortal danger of electric shock.**

**Cover up live parts in the installation environment.**



### 6.1 Fitting and electrical connection

#### Detection field and range

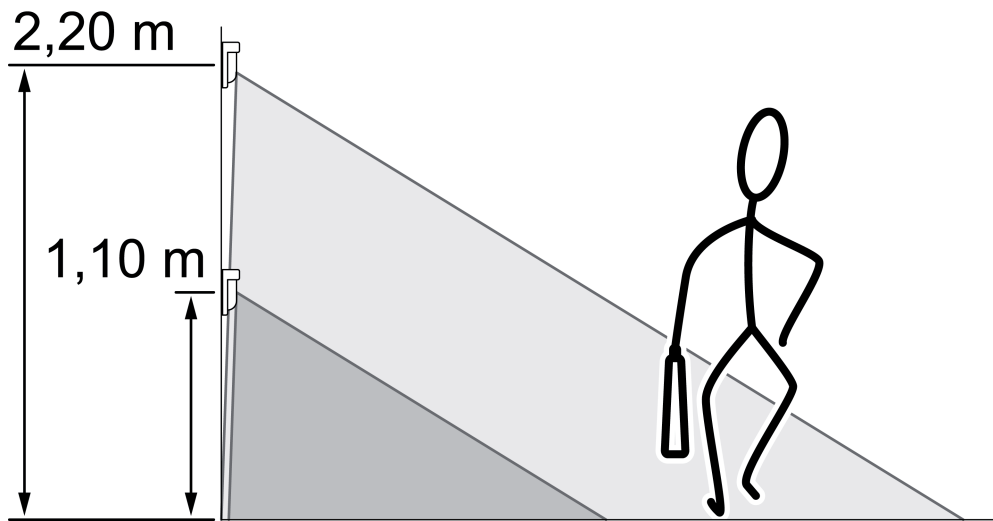

Figure 8: Detection field and mounting height

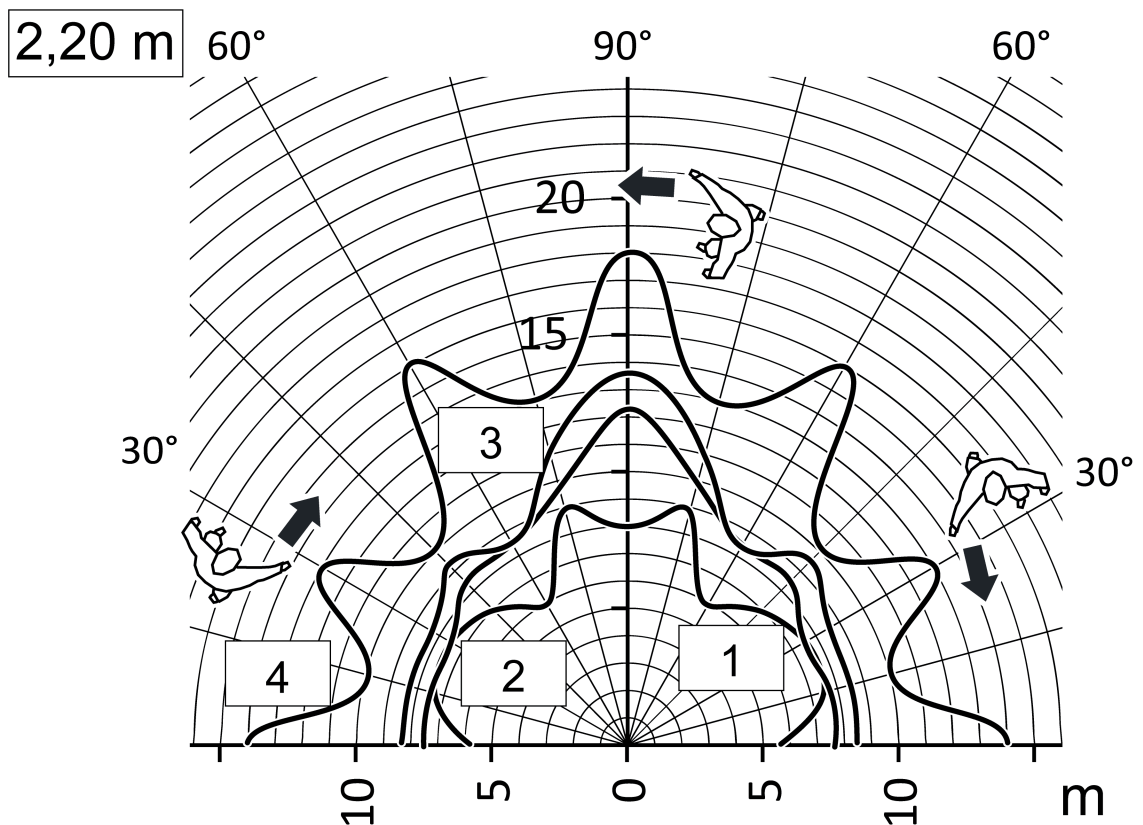

Figure 9: Range with tangential direction of motion, mounting height 2.20 m

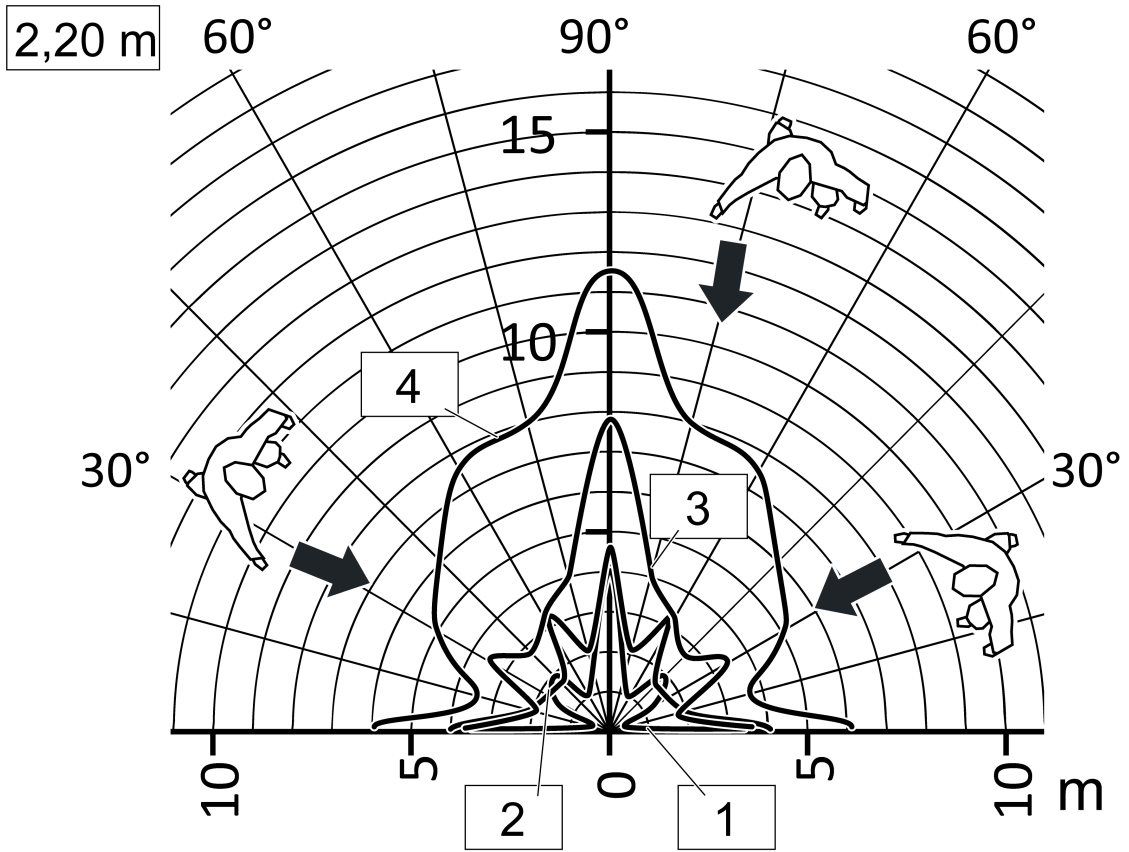

Figure 10: Range with radial direction of motion, mounting height 2.20 m

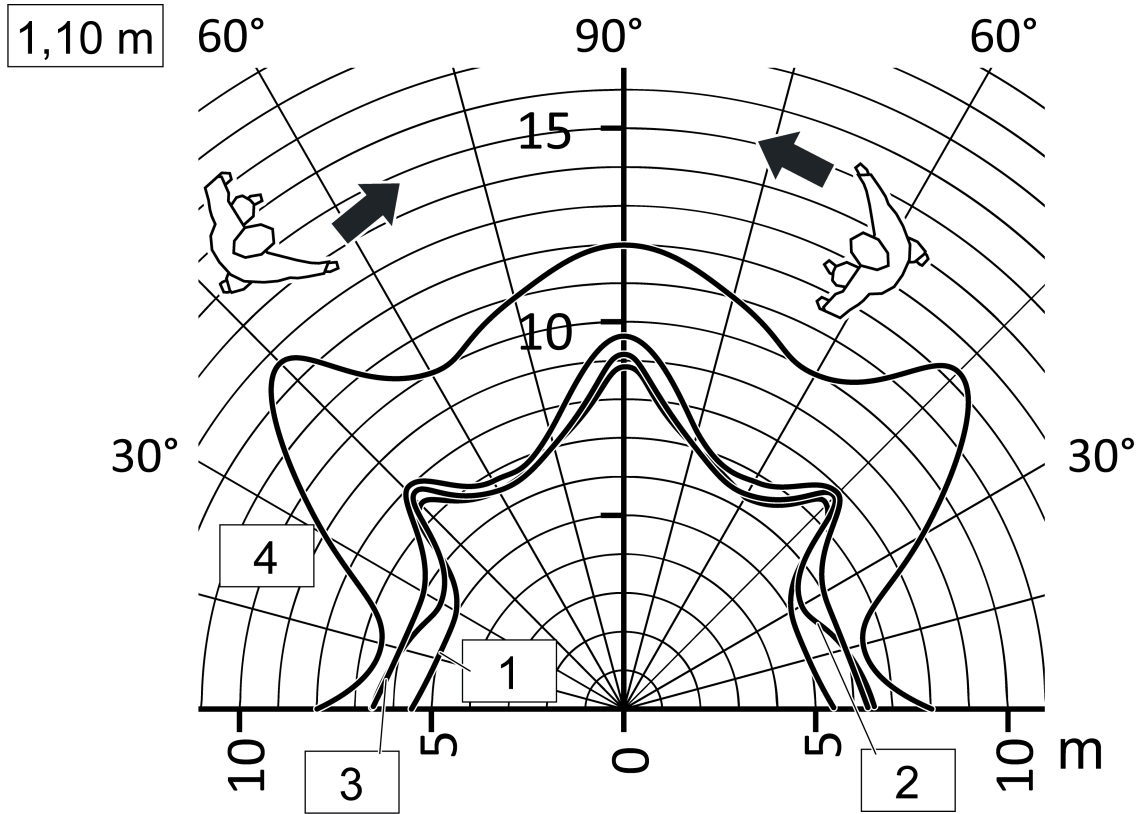

Figure 11: Range with tangential direction of motion, mounting height 1.10 m

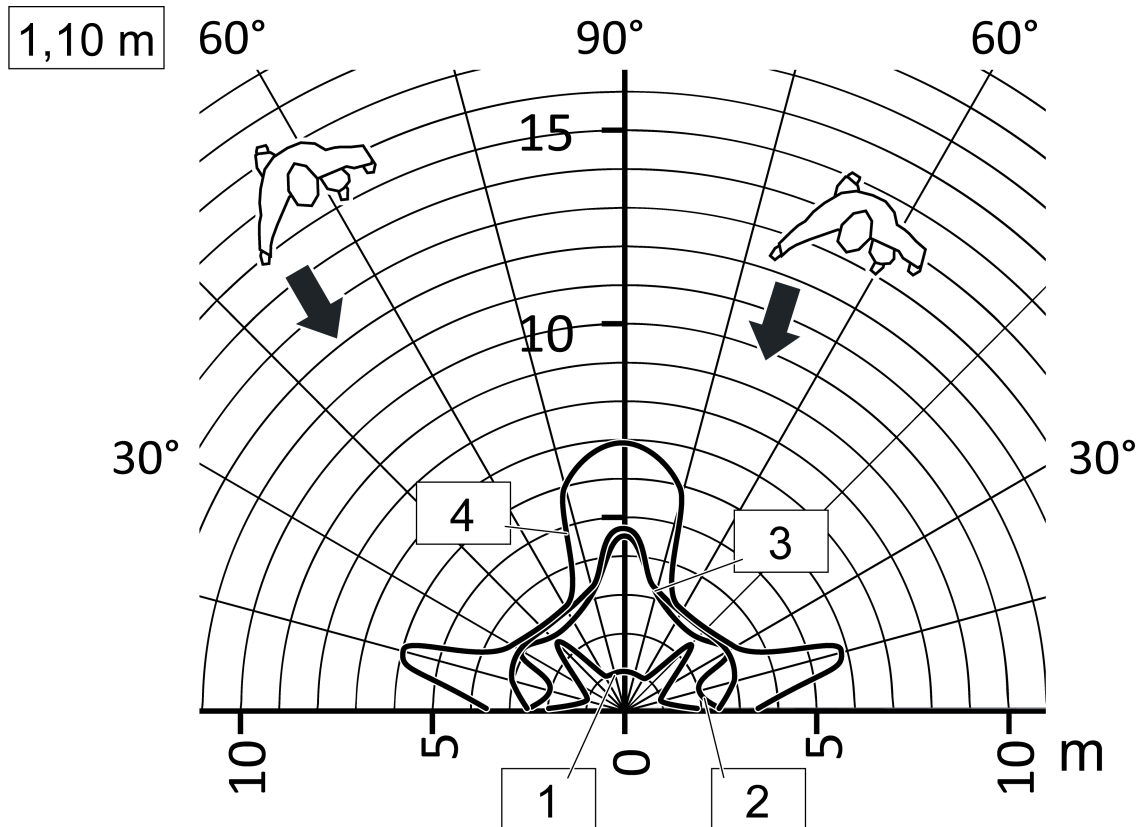

Figure 12: Range with radial direction of motion, mounting height 1.10 m

The size of the detection area depends on the mounting height, the direction of motion and the adjusted sensitivity. As the distance to the detector increases, the detection density and sensitivity decrease.

4: High sensitivity

1: Low sensitivity

- i The specifications on the extent of the detection area are general guide values. Discrepancies can occur depending on the installation environment and the intensity of the heat motion.
- i The basic sensitivity can be reduced in order to minimize faulty switching outdoors (e.g. from wind).

#### Selecting installation location

- Select a vibration-free installation location. Vibrations can lead to unwanted switching.
- To achieve optimum range, choose an installation location that is transversal to the direction of motion.
- Avoid interference sources in the detection area. Interference sources, e.g. heaters, ventilation, air conditioners, and cooling light bulbs can lead to unwanted detections.

#### Limiting the detection area

The detection area can be limited as required.

- Switch off the left or right PIR sensor with parameter setting. Detection angle approx. 100°.

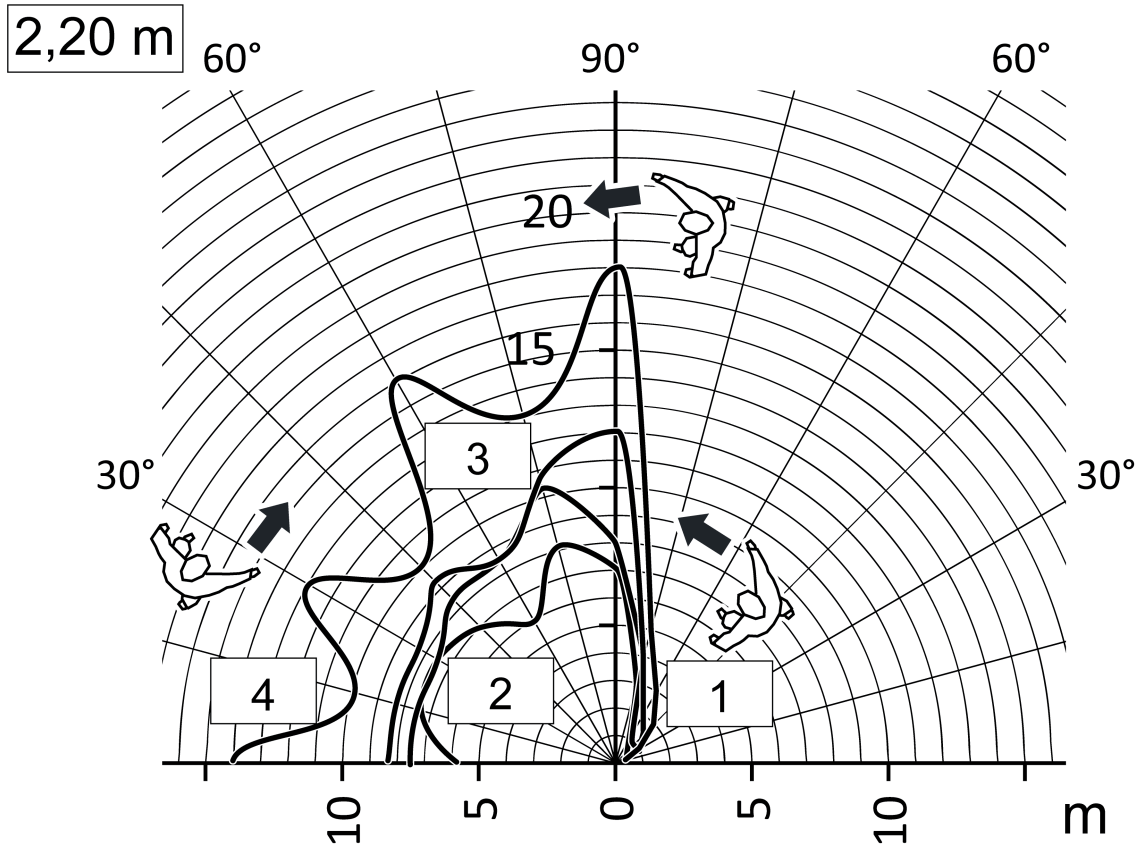

Figure 13: Range with tangential direction of motion, mounting height 2.20 m, only one sensor active

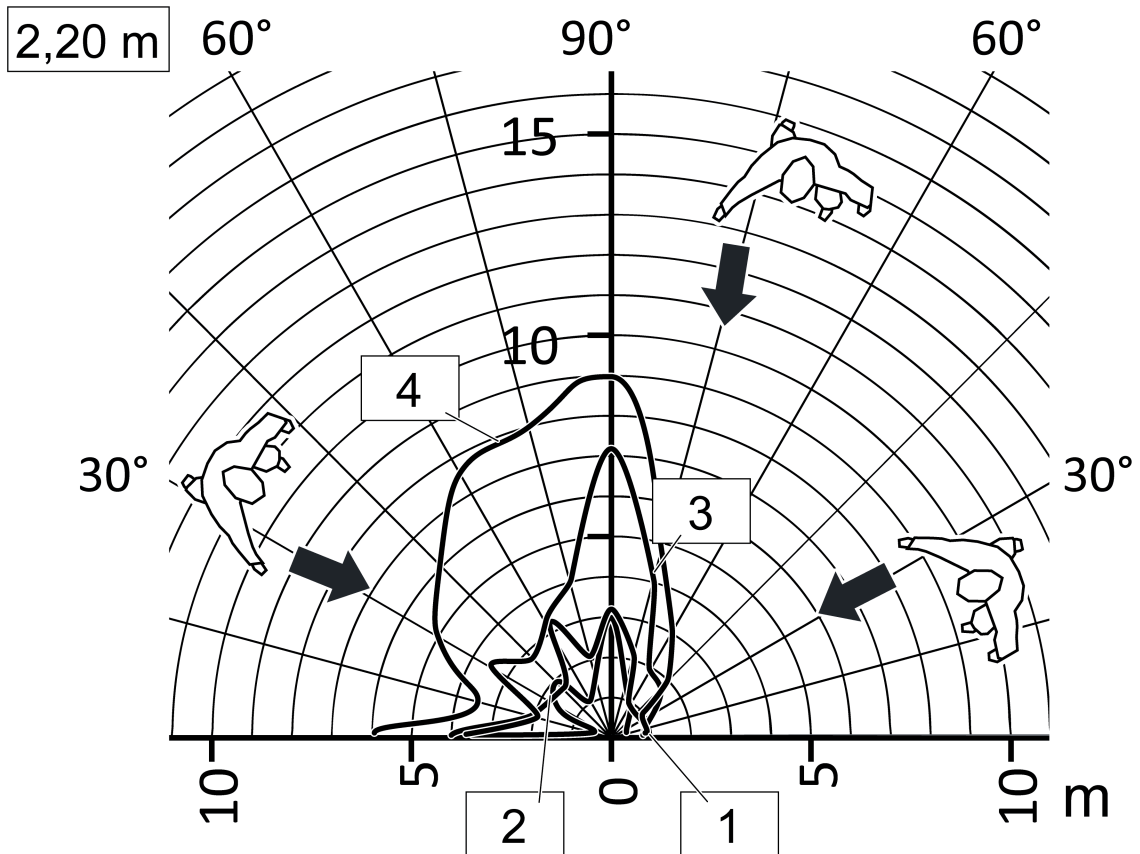

Figure 14: Range with radial direction of motion, mounting height 2.20 m, only one sensor active

### Fitting the device

Prerequisite: Bus coupler (1) is mounted in an appliance box and connected.

- Install the motion detector (3) with frame (2) onto the bus coupler (1) in the correct orientation.
- ⓘ Further installation steps are necessary to ensure the degree of protection IP 44 (see Seal set instructions).

## 6.2 Commissioning

### Load physical address and application program

- Press the **AUTO / I** button for approx. 5 seconds until the red LED in the lens lights up.
- Assign physical address.  
The red LED goes out.
- Write the physical address on the device label.
- Load the application program into the device.
- ⓘ In case of active temperature measurement ("Universal" version) compare the temperature measurement.

### Testing the detection area

In the case of main units and extensions, check the detection areas of the devices individually.

Precondition: The device is installed and connected. The physical address is loaded.

- Activate the walking test:  
Activate the parameter "Walking test after ETS programming" and download the application software.

The device now operates brightness-independently. The PIR sensors are active according to their programmed sensitivity.

- Pace off the detection field, paying attention to reliable detection and interference sources. Any motions detected are displayed by the blue LED.
- Limit the detection area as required. Adjust sensitivity with adjuster **Sens.** or IR remote control, or change the programming.
- Deactivate the parameter "Walking test after ETS programming" and download the application software.

Only for "Universal" version:

- i** If enabled, the walking test function can be activated with the button **Test** of the IR remote control.

## 7 Appendix

### 7.1 Technical data

Commissioning mode	S-mode
Current consumption KNX	3 ... 10 mA
Ambient temperature	-25 ... +55 °C
Storage/transport temperature	-25 ... +70 °C
Relative humidity	10 ... 100 % (No moisture condensation)
Protection class	III
Installation height	1.10 / 2.20 m
Detection angle	180 °
Brightness sensor	
Measuring range	approx. 1 ... 1000 lx
Temperature sensor	
Measuring range	approx. -20 ... +55 °C
Accuracy	± 1 K

### 7.2 Accessories

Bus coupling unit 3	Art. No. 2073U
IR remote control	Art. No. KNXPMFBIR
Sealing kit for automatic switch 180° 2.20 m	Art. No. AS..50DS

### 7.3 Warranty

The warranty follows about the specialty store in between the legal framework as provided for by law.

#### ALBRECHT JUNG GMBH & CO. KG

Volmestraße 1  
58579 Schalksmühle  
GERMANY

Telefon: +49 2355 806-0  
Telefax: +49 2355 806-204  
kundencenter@jung.de  
www.jung.de