



- Blinds actuator, 4-gang DC 12-48 V**  
Art. No. 2424 REG HE
- Blinds actuator, 2-gang AC 230 V, 1-gang DC 12-48 V**  
Art. No. 2502 REG HE
- Blinds actuator, 4-gang AC 230 V, 2-gang DC 12-48 V**  
Art. No. 2504 REG HE
- Blinds actuator, 8-gang AC 230 V, 4-gang DC 12-48 V**  
Art. No. 2508 REG HE
- Art. No. 2514 REG HE
- Shutter actuator 4-gang AC 230 V**  
Art. No. 2504 REGHER

**Operating instructions**

**1 Safety instructions**

Electrical equipment may only be installed and fitted by electrically skilled persons. Failure to observe the instructions may cause damage to the device and result in fire and other hazards.

**Danger of electric shock. Device is not suitable for disconnection from supply voltage.**

For parallel connection of several motors to an output it is essential to observe the corresponding instructions of the manufacturers, and to use a cut-off relay if necessary. The motors may be destroyed.

Use only venetian blind motors with mechanical or electronic limit switches. Check the limit switches for correct adjustment. Observe the specifications of the motor manufacturers. Device can be damaged.

**Danger of electric shock on the SELV/PELV installation. Do not connect loads for mains voltage and SELV/PELV together on a single Venetian blind actuator.**

These instructions are an integral part of the product, and must remain with the end customer.

**2 Device components**

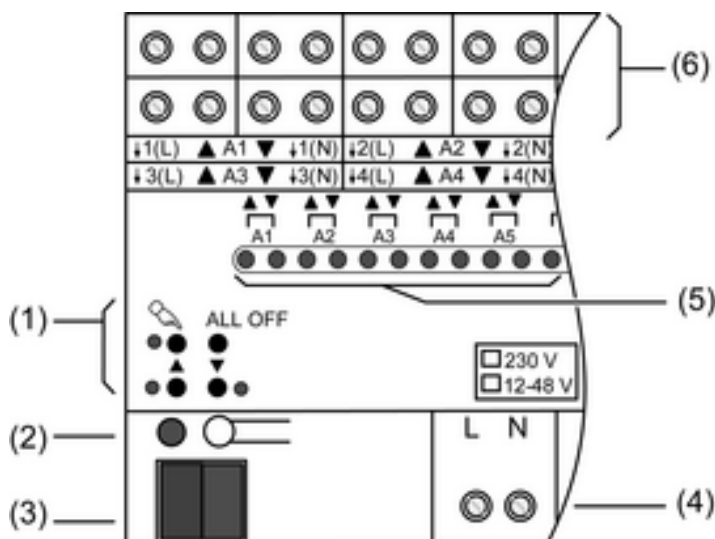

Figure 1

- (1) Button field for manual control
- (2) Programming button and LEDs
- (3) KNX connection
- (4) Connection for mains supply

- (5) Status LEDs for outputs
- (6) Connection for Venetian blind motors

### 3 Function

#### System information

This device is a product of the KNX system and complies with the KNX directives. Detailed technical knowledge obtained in KNX training courses is a prerequisite to proper understanding.

The function of this device depends upon the software. Detailed information on loadable software and attainable functionality as well as the software itself can be obtained from the manufacturer's product database.

Planning, installation and commissioning of the device are carried out with the aid of KNX-certified software. Full functionality with KNX commissioning software version ETS3.0d onwards.

An updated version of the product database, technical descriptions and conversion programs and other auxiliary programs are available on our Internet website.

#### Intended use

- Switching of electrically driven Venetian blinds, rolling shutters, awnings and similar hangings for AC 230 V mains voltage or DC 12...48 V extra-low voltage.
- Mounting on DIN rail according to EN 60715 in distribution boxes

#### Product characteristics

- Outputs can be operated manually, construction site mode
  - Blind/shutter position directly controllable
  - Acknowledgement of the blind/shutter position in bus and manual mode
  - Safety functions: 3 independent wind alarms, rain alarm, frost alarm
  - Integration into the temperature management of the building
  - Disabling of individual outputs manually or via bus
- i** Delivery state: Outputs can be operated using button field, construction site mode.

Only shutter actuators:

- Suitable for 230 V AC motors and 12...48 V DC motors
- Automatic operation time detection for 230 V motors can be set
- Slat position directly controllable
- Acknowledgement of travelling state and slat position in bus and manual mode
- Light scene function
- "Top" and "Bottom" forced position via higher-level controller
- Sun protection function

Only Venetian blind actuator 2414 RMD HE:

- Blind/shutter correction for lower end position (e.g. for ventilation position for roller blinds)
- Status feedback for automatic operation

## 4 Operation

### Operating elements

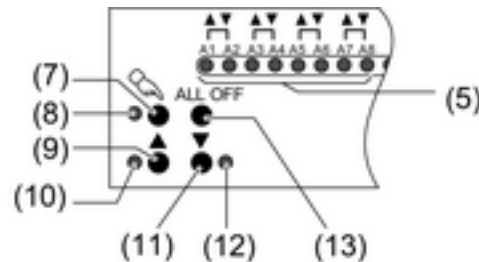

Figure 2

- (5) Status LEDs for outputs
- (7) Button – Manual control
- (8) LED – on: continuous manual mode
- (9) Button : move hanging up/Stop
- (10) LED – on: hanging moves up, manual mode
- (11) Button : move hanging downwards/Stop
- (12) LED – on: hanging moves down, manual mode
- (13) Button **ALL OFF**: Stop all hangings

In operation with the button field the device distinguishes between a short and a long press.

- Short: pressing for less than 1 second
- Long: pressing for between 1 and 5 seconds

### Status indication

The status LED **A1...** (5) indicate the states of the outputs.

- Off: Output switched off
- On: Output switched on
- Flashes slowly: Output in manual mode
- Flashes quickly: Output disabled via continuous manual mode

### Operating modes

- Bus operation: Operation via push-button sensors or other bus devices
- Short-term manual operation: Manual operation locally with button field, automatic return to bus operation.
- Continuous manual mode: Exclusively manual operation on the device

- No bus operation is possible in manual mode.
- No manual mode is possible in case of bus failure.
- After a bus failure and restoration the device switches to bus operation.
- After a power failure and restoration the device switches to bus operation.
- The manual mode can be disabled in ongoing operation via a bus telegram.

### Priorities

- Highest priority: manual mode
- 2nd priority: forced position
- 3rd priority: safety function
- 4th priority: sun protection
- Lowest priority: bus mode: moving up/down, slat positioning, scenes, positioning

### Switching on the temporary manual control

Operation using the button field is programmed and not disabled.

- Press the button briefly.

LEDs **A1** flash, LED  remains off.

- i** After 5 seconds without a button-press, the actuator returns automatically to bus operation.

### Deactivating temporary manual control

The device is in short-term manual mode.



- No button-press for 5 seconds.  
- or -
- Press  button briefly as many time as necessary until the actuator leaves the short-time manual mode.

LEDs **A1**... no longer flash, but rather indicate the output status.

Depending on the programming, the hangings move to the position that is active after the manual mode is switched off, e.g. to the forced position, safety or sun protection position.



### Switching on permanent manual control

Operation using the button field is programmed and not disabled.

- Press the  button for at least 5 seconds.  
LED  is illuminated, LEDs **A1** flash, continuous manual mode is switched on.

### Deactivating permanent manual control

The device is in continuous manual mode.

- Press the  button for at least 5 seconds.  
LED  is off, bus operation is switched on.

Depending on the programming, the hangings move to the position that is active after the manual mode is switched off, e.g. to the forced position, safety or sun protection position.

### Operating the outputs

The device is in continuous or short-term manual mode.

- Press  button briefly as many times as necessary until the desired output is selected.  
LEDs of the selected output **A1**... flash.  
The LEDs ▲ and ▼ indicate the status.
- Operate output with ▲ or ▼ button.  
Short: Stop hanging.  
Long: Move hanging upwards/downwards.  
The selected hanging executes the corresponding commands.  
The LEDs ▲ and ▼ indicate the status.

- i** Short-term manual operation: After running through all of the outputs the device exits manual mode after another brief press.

### Stop all hangings

The device is in continuous manual mode.

- Press the **ALL OFF** button.  
All outputs switch off; all hangings stop moving.

### Disabling individual outputs

The device is in continuous manual mode.

- Press  button briefly as many times as necessary until the desired output is selected.  
The status LEDs of the selected output **A1**... flash.
- Press buttons ▲ and ▼ simultaneously for at least 5 seconds.  
Selected output **A1**... is disabled.  
The status LEDs of the selected output **A1**... flash quickly.
- Activate bus mode (see section Deactivating permanent manual control).

- i** A disabled output can be operated in manual mode.

- i** When a disabled output is selected in manual mode, the corresponding status LEDs flash twice briefly at intervals.

### Re-enabling outputs

The device is in continuous manual mode.

- Press  button briefly as many times as necessary until the desired output is selected. The status LEDs of the selected output **A1...** flash twice briefly at time intervals.
- Press buttons **▲** and **▼** simultaneously for at least 5 seconds. Selected output **A1...** is enabled. LEDs of the selected output **A1...** flash slowly.
- Activate bus mode (see section Deactivating permanent manual control).

## 5 Information for electrically skilled persons

### 5.1 Fitting

#### Fitting the device



#### **DANGER!**

Electrical shock when live parts are touched.

Electrical shocks can be fatal.

**Before carrying out work on the device or load, disengage all the corresponding circuit breakers. Cover up live parts in the working environment.**



#### **CAUTION!**

Danger of destruction if several motors are connected in parallel to one output.

Limit switch contacts can weld together and motors, blinds/shutters and the venetian blind actuator can be destroyed.

**Observe the manufacturer's instructions. Use cutoff relay if necessary!**

Observe the temperature range. Ensure sufficient cooling.

- Mount the device on DIN rail. Output terminals must be at the top.

#### Installing the cover

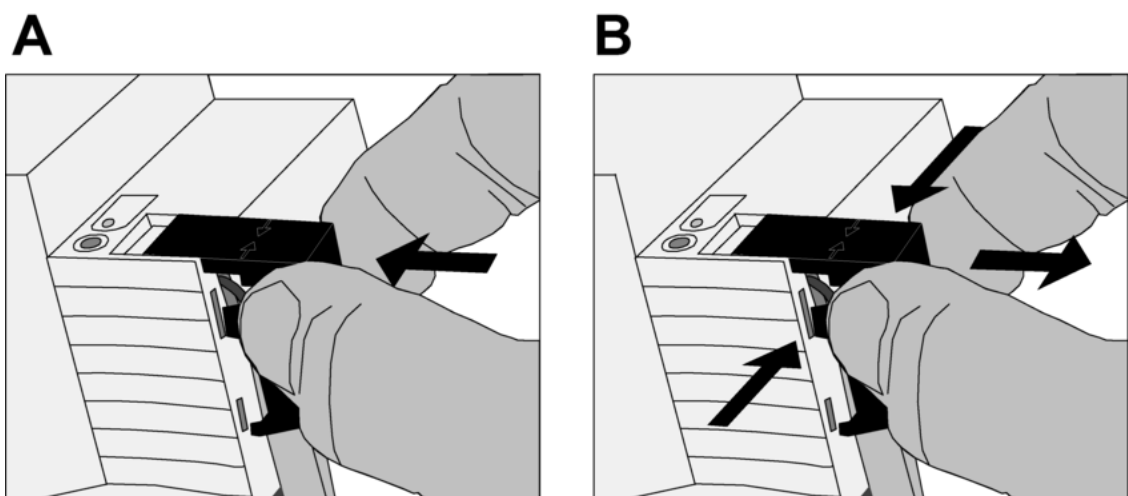

Figure 3

After connection of the bus cable Install the cover to protect the bus connection against hazardous voltages in the connection area.

- Route the bus cable towards the rear.
- Install cover on top of the bus terminal so that it snaps into place.

### Removing the cover

- Press the cover to the side and pull it off.

## 5.2 DC 24 V venetian blind actuator: electrical connection

### Connecting the device

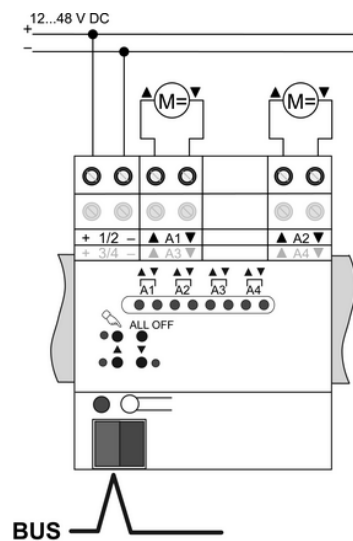

Figure 4

Only for DC motors 12...48 V. Observe the admissible load ratings.

- Connect bus cable with connecting terminal.

Terminals **1/2** supply power to the device electronics and outputs **A1** and **A2**. For operation of the actuator it is necessary to connect an external 24 V DC power supply to **1/2**.

Terminals **3/4** supply power to outputs **A3** and **A4**.



### CAUTION!

**The polarity of the external power supply units must be the same.**

**There is otherwise risk of irreparable damage to the actuator.**

**Note polarity of the external voltages.**

The supply voltages must be designed in such a way that a safe and reliable operating voltage is provided under all load conditions – especially when the motors are first switched on.

Do not connect any AC voltage.

- Connect power supply to terminals **1/2** or **3/4**.
- Connect motors to load terminals **A1** ... **A4**.



Drives for venting louvers or windows must be connected in such a way that they open in travel direction "UP" and close in travel direction "DOWN".

### 5.3 Shutter actuators AC 230 V and roller shutter actuator: electrical connection

#### Connecting the device without automatic operation time detection

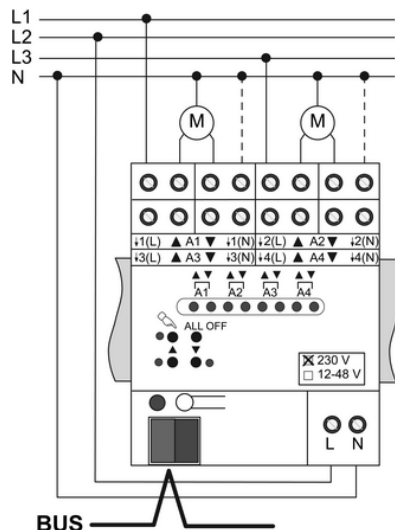

Figure 5

- Connect bus cable with connecting terminal (figure 5).
  - Connect mains voltage supply (figure 5).
  - Connecting the motors (figure 6).
  - Mark **230 V** use on label (figure 6).
- i** The N conductor connections (14) serve only to detect the operation time and do not provide any N potential.
- i** If motors with high-impedance inputs are connected, then the corresponding N conductor can be connected. The associated output must not be under current for a longer period without interruption due to retriggering. This can lead to impermissible heating of the device. Note maximum duty cycle (see chapter "Technical data").

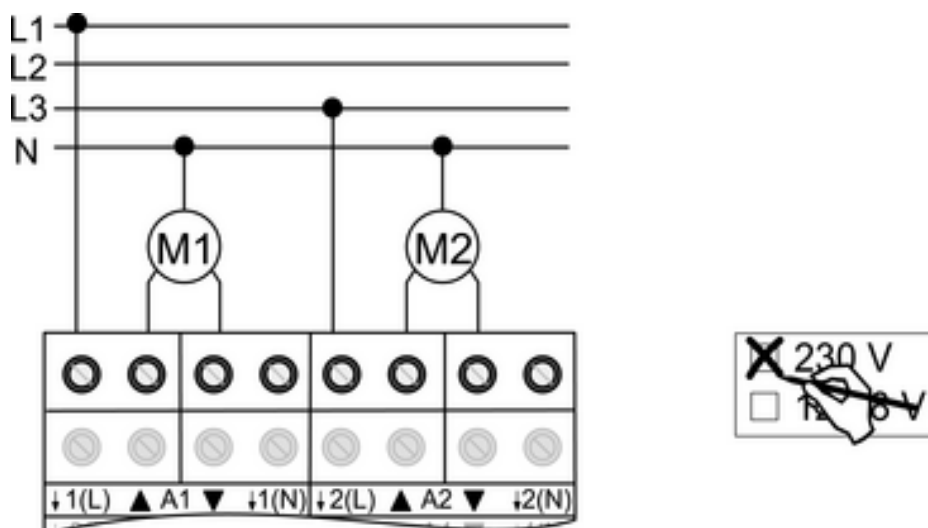

Figure 6

Connecting the device with automatic operation time detection

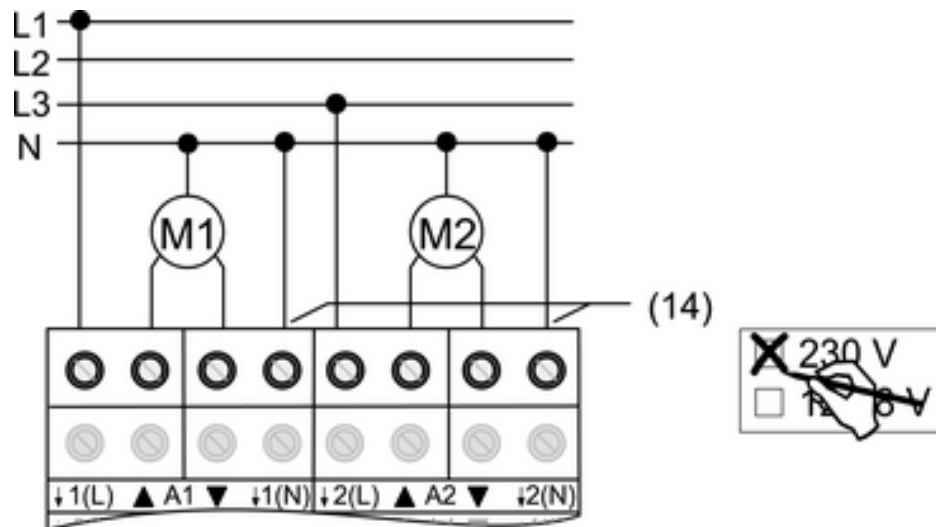

Figure 7

**i** Not for roller shutter actuator.

When appropriately programmed and wired, the venetian blind actuator detects the operation time of the individual hangings and saves them. The actuator measures the voltage at the outputs against the connected neutral conductor (14), and uses it to determine the end positions. During operation the venetian blind actuator adjusts itself to changed operation times, e.g. due to ageing of the motors.

**i** The automatic operation time detection cannot be used for 110 V AC motors, DC motors, motors with electronic limit switches, or for motors that are connected to the outputs using cutoff relays.

**i** Only for 230 V AC motors with mechanical limit switches.

Automatic operation time detection is activated in the application software.

Hangings are not disabled.

- Connect bus cable with connecting terminal (figure 5).
- Connect mains voltage supply (figure 5).

**i** Connect only one motor per output.

- Connecting the motor (figure 7).
- Connect the N conductor of the corresponding motor to the N conductor terminals (14) (figure 7). Note RCCB wiring.
- Mark **230 V** use on label (figure 7).

**i** The N conductor connections for the individual outputs and mains voltage connection are not connected internally.

**i** If an output is energised without interruption for a prolonged time due to retriggering, the device may heat up excessively. Note maximum duty cycle (see chapter "Technical data").

**i** The automatic operation time detection is performed during commissioning and the determined operation time is saved permanently.



**Connecting the device for 12...48 V DC motors**

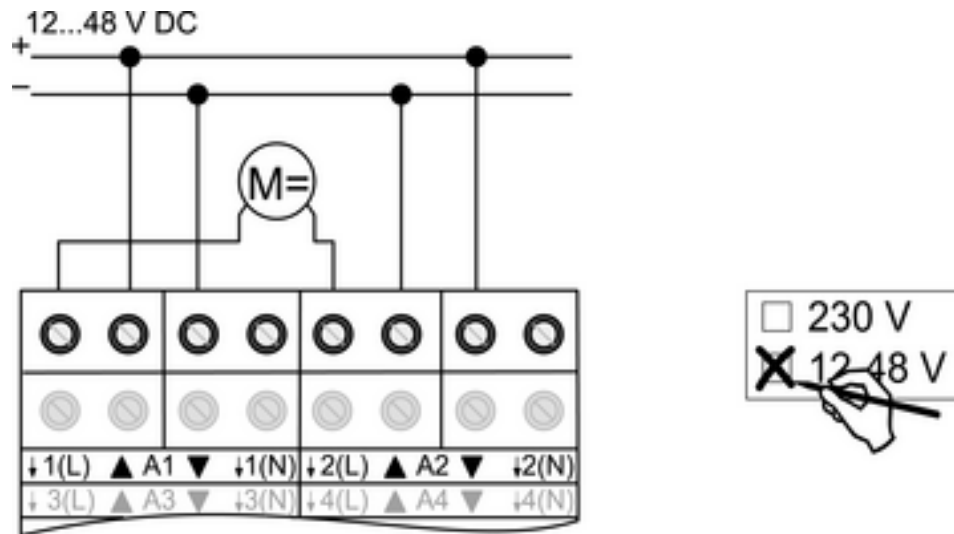

Figure 8

**i** Not for roller shutter actuator.

The adjacent Venetian blind outputs **A1** and **A2** ... **A7** and **A8** can be used jointly to switch a DC motor.

The venetian drive actuator is programmed as a DC device.

- Connect bus cable with connecting terminal (figure 5).
- Connect mains voltage supply (figure 5).

**i** Connect only one motor per output.

- Connecting the motors (figure 8).
- Mark **12-48 V** use on label (figure 8).

**i** For DC operation, manual mode for outputs **A2**, **A4**... is without function. The status LEDs indicate the relay states.

**5.4 Commissioning**

**Measuring the hanging and slat operation time**

The hanging operation time is important for position and scene runs. For slatted Venetian blinds the slat adjusting time is by design part of the overall hanging operation time. The opening angle of the slats is therefore set as the operation time between the positions "Open" and "Closed".

The upwards travel generally lasts longer than the downwards travel, and is taken into account as the operation time extension in %.

- Measure upwards and downwards operation time of the hanging.
- Measure slat adjusting time between "Open" and "Closed".
- Enter the measured values in the parameter setting – Downwards travel in seconds and operation time extension in percent.

**i** In the case of automatic operation time detection, no measurement of the hanging operation times is performed.

**i** Automatic measurement of the slat adjusting time is not possible.

**Load the address and the application software**

- Switch on the bus voltage
- Assign physical address.
- Load the application software into the device.

- Note the physical address on the device label.

### Performing a reference run

The Venetian drive actuator can only move to scenes and directly called positions only if it has saved the positions of the hangings. To do this, each output has to perform a reference run.

- Move hangings to the upper end position.
- Wait until the output relay and the limit switch have switched off.
- i** The Venetian blind actuator does not save the hangings position permanently. After a power failure and restoration it carries out another reference run.
- i** Without a reference run the Venetian blind actuator generates an internal "Invalid position" message for each output that can be read out.

### Automatic operation time detection: save operation times

- i** Not for roller shutter actuator.
- i** Only for 230 V motors.

When operation time detection is activated, the device can only set positions and scenes when it has saved the operation times. The operation times must be saved during interference-free conditions, i.e. no additional operations, no wind, no snow, no obstructions.

Automatic operation time detection is activated in the application software.

The associated N conductors are connected for the outputs in question (Figure 5).

- i** Teaching runs must be performed only in manual mode or using commissioning software.
  - Move hangings to the upper end position (see chapter "Perform reference run").

Upper end position has been reached:

- Move hangings to lower end position in manual mode.
  - Move hangings to upper end position in manual mode.
- Operation times have been saved.
- i** The venetian blind actuator saves the operation times permanently.
  - i** Without saved operation times the venetian blind actuator generates an internal "Invalid position" message for each output that can be read out.
  - i** During operation the venetian blind actuator adjusts itself to changed blind/shutter travelling times, e.g. caused by ageing of the motors. The slat operation time is taken into account here. The changed times are only saved permanently in continuous manual mode.

## 6 Appendix

### 6.1 Technical data

Supply

Rated voltage

Art. No. 2424 REG HE	DC 12 ... 48 V =
Art. No. 2502 REG HE	AC 230 / 240 V ~
Art. No. 2504 REG HE	AC 230 / 240 V ~
Art. No. 2508 REG HE	AC 230 / 240 V ~
Art. No. 2514 REG HE	AC 230 / 240 V ~
Art. No. 2504 REGHER	AC 230 / 240 V ~

Mains frequency

Art. No. 2424 REG HE	—
Art. No. 2502 REG HE	50 / 60 Hz
Art. No. 2504 REG HE	50 / 60 Hz
Art. No. 2508 REG HE	50 / 60 Hz
Art. No. 2514 REG HE	50 / 60 Hz
Art. No. 2504 REGHER	50 / 60 Hz

Ambient conditions

Ambient temperature	-5 ... +45 °C
Storage/transport temperature	-25 ... +70 °C

Power loss

Art. No. 2424 REG HE	max. 1 W
----------------------	----------

Art. No. 2502 REG HE	max. 4.5 W
Art. No. 2504 REG HE	max. 4.5 W
Art. No. 2508 REG HE	max. 6 W
Art. No. 2514 REG HE	max. 4.5 W
Art. No. 2504 REGHER	max. 4.5 W
Venetian blind outputs	
Minimum switching current	100 mA
Switching current AC 250 V	—
Art. No. 2424 REG HE	—
Art. No. 2502 REG HE	AC 6 A
Art. No. 2504 REG HE	AC 6 A
Art. No. 2508 REG HE	AC 6 A
Art. No. 2514 REG HE	AC 6 A
Art. No. 2504 REGHER	AC 6 A
Switching current DC 12 V	—
Art. No. 2424 REG HE	6 A
Art. No. 2502 REG HE	6 A
Art. No. 2504 REG HE	6 A
Art. No. 2508 REG HE	6 A
Art. No. 2514 REG HE	6 A
Art. No. 2504 REGHER	—
Switching current DC 24 V	—
Art. No. 2424 REG HE	6 A
Art. No. 2502 REG HE	6 A
Art. No. 2504 REG HE	6 A
Art. No. 2508 REG HE	6 A
Art. No. 2514 REG HE	6 A
Art. No. 2504 REGHER	—
Switching current DC 48 V	—
Art. No. 2424 REG HE	3 A
Art. No. 2502 REG HE	3 A
Art. No. 2504 REG HE	3 A
Art. No. 2508 REG HE	3 A
Art. No. 2514 REG HE	3 A
Art. No. 2504 REGHER	—
Blind/shutter travelling time	max. 20 min
Duty cycle	max. 50% (cycle time ≤ 40 min)
Automatic operation time adaptation	—
Art. No. 2424 REG HE	max. 20% of the blind/shutter travelling time
Art. No. 2502 REG HE	max. 20% of the blind/shutter travelling time
Art. No. 2504 REG HE	max. 20% of the blind/shutter travelling time
Art. No. 2508 REG HE	max. 20% of the blind/shutter travelling time
Art. No. 2514 REG HE	max. 20% of the blind/shutter travelling time
Art. No. 2504 REGHER	—
Fitting width	
Art. No. 2424 REG HE	72 mm / 4 modules
Art. No. 2502 REG HE	72 mm / 4 modules
Art. No. 2504 REG HE	72 mm / 4 modules
Art. No. 2508 REG HE	144 mm / 8 modules
Art. No. 2514 REG HE	72 mm / 4 modules
Art. No. 2504 REGHER	72 mm / 4 modules
Weight	
Art. No. 2424 REG HE	approx. 300 g
Art. No. 2502 REG HE	approx. 250 g
Art. No. 2504 REG HE	approx. 300 g
Art. No. 2508 REG HE	approx. 550 g
Art. No. 2514 REG HE	approx. 300 g
Art. No. 2504 REGHER	approx. 300 g
Connections supply and load	
Connection mode	Screw terminal
single stranded	0.5 ... 4 mm <sup>2</sup>
finely stranded with conductor sleeve	0.14 ... 2.5 mm <sup>2</sup>
finely stranded without conductor sleeve	0.34 ... 4 mm <sup>2</sup>

KNX  
 KNX medium  
 Commissioning mode  
 Rated voltage KNX  
 Power consumption KNX  
 Connection mode KNX

TP 1  
 S-mode  
 DC 21 ... 32 V SELV  
 typical 150 mW  
 Standard terminal

## 6.2 Troubleshooting

### Manual control with button field not possible

Cause 1: Manual control has not been programmed.

Program manual control.

Cause 2: Manual control via bus disabled.

Enable manual control.

### Output cannot be operated.

Cause 1: Output is disabled.

Cancel disabling.

Cause 2: Forced position, safety function or sun protection is active for the output in question.

As long as higher-order functions are active for an output, this output cannot be operated.

Cause 3: Motor with high-impedance input is connected.

Connect N conductor for the corresponding output.

**i** Note connection instructions. Note maximum duty cycle (Technical data). If the N conductor is connected and the associated output is under current for a longer period without interruption due to retriggering, then impermissible heating of the device may result.

### None of the outputs can be operated.

Cause 1: All of the outputs are disabled-

Cancel disabling.

Cause 2: Continuous manual mode is active.

Deactivate manual mode (see chapter "Switch off continuous manual mode").

Cause 3: Forced position, safety function or sun protection is active for all outputs.

As long as higher-order functions are active, no operation is possible.

Cause 4: Application software has been stopped, programming LED is flashing.

Perform reset: Disconnect device from bus, switch on again after 5 seconds.

### Position- and scene runs are not executed or executed improperly

Cause 1: Sun protection, safety function or manual mode is activated.

As long as higher-order functions are active, no position or scene runs are possible.

Cause 2: No operation time saved.

Save operation times (see chapter "Automatic operation time detection: save operation times").

**i** Without saved operation times the Venetian blind actuator moves the hangings upwards or downwards for position and scene runs – depending on whether the hangings are in the upper or lower half.

Cause 3: Automatic operation time detection is activated and N conductor is not connected.

Correct electrical connection

- or -

Deactivate automatic operation time detection.

Cause 4: Automatic operation time detection is activated, but the switching voltage is < 230 V or motors with electronic limit switches are being used.

Deactivate automatic operation time detection.

Correct electrical connection and remove N conductor.

**Hanging does not move to end position, position and scene runs faulty.**

Cause: Hanging operation time has been set incorrectly.

Correct hanging operation time.

**The hanging moves upwards before the positioning and scene run.**

Cause: No position saved, e.g. due to power failure.

Hanging performs reference run. Do not interrupt hanging run.

**6.3 Accessories**

Connection cover  
Isolating relay AP  
Isolating relay REG  
Isolating relay UP

Art. No. 2050 K  
Art. No. TR-S  
Art. No. TR-S REG  
Art. No. TR-SUP

**6.4 Warranty**

We reserve the right to make technical and formal changes to the product in the interest of technical progress.

We provide a warranty as provided for by law.

Please send the unit postage-free with a description of the defect to our central customer service office.

**ALBRECHT JUNG GMBH & CO. KG**

Volmestraße 1  
58579 Schalksmühle

Telefon: +49 23 55.8 06-0  
Telefax: +49 23 55.8 06-2 04  
kundencenter@jung.de  
www.jung.de

**Service Center**

Kupferstr. 17-19  
44532 Lünen  
Germany