

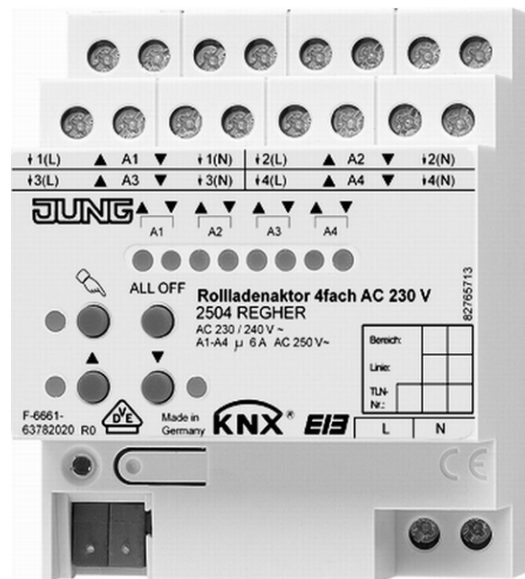

Product documentation

Shutter actuator 4-gang AC 230 V
Art.-No.: 2504 REGHER



ALBRECHT JUNG GMBH & CO. KG
Volmestraße 1
D-58579 Schalksmühle

Telefon: +49.23 55.8 06-0
Telefax: +49.23 55.8 06-1 89
E-mail: mail.info@jung.de
Internet: www.jung.de
www.jung-katalog.de

Contents

1	Product definition	3
1.1	Product catalogue	3
1.2	Function	3
2	Installation, electrical connection and operation	4
2.1	Safety instructions	4
2.2	Device components	5
2.3	Fitting and electrical connection	6
2.4	Commissioning	9
2.5	Operation	11
3	Technical data	14
4	Software description	15
4.1	Software specification	15
4.2	Software "Shutter 20CD11"	16
4.2.1	Scope of functions	16
4.2.2	Notes on software	17
4.2.3	Object table	18
4.2.4	Functional description	21
4.2.4.1	Description of channel-independent functions	21
4.2.4.2	Channel-oriented functional description	27
4.2.4.3	Delivery state	40
4.2.5	Parameters	41
5	Appendix	53
5.1	Index	53

1 Product definition

1.1 Product catalogue

Product name: Shutter actuator 4-gang AC 230 V SE

Use: Actuator

Design: Rail-mounted device

Art.-No.: 2504 REGHER

1.2 Function

The shutter actuator receives telegrams from sensors or other controls via KNX, and with its independent contacts, switches electrically driven shutters, awnings or similar blinds/shutters for 230 V AC mains supply. Each shutter output has a mains-dependent monostable switching relay so that preferred states can also be preset in case of bus voltage failure.

The controls (4 pushbuttons) on the front panel of the device permit switching the relays on and off by hand in parallel with the KNX even without bus voltage or in a non-programmed state. This feature permits fast checking of connected motors for proper functioning.

The function features that are independently adjustable for every output channel by means of the ETS include, for example, separately configurable travelling times, positioning functions, extended feedback functions and an assignment of outputs for up to 5 different safety functions. Moreover, the preferred states of the relays in case of bus voltage failure or bus / mains voltage return and after ETS programming can be preset separately.

For project design and commissioning of this device, we recommend using the ETS3.0 from Version d patch A or ETS 4.0. The advantages with regard to downloading (shorter loading times) are available only if this ETS versions are used.

The shutter actuator has its own mains supply independent of the connected drives. For actuation of the outputs, the 230 V mains supply must always be switched on. The integrated bus coupler is supplied from the bus voltage or the mains voltage, meaning that the device can only be programmed using the ETS when the KNX bus voltage is switched on.

The device is designed for mounting on DIN rails in closed compact boxes or in power distributors in fixed installations in dry rooms.

2 Installation, electrical connection and operation

2.1 Safety instructions

Electrical devices may only be fitted and installed by electrically skilled persons. The applicable accident prevention regulations must be observed.

Failure to observe the instructions may cause damage to the device and result in fire and other hazards.

Always disconnect before carrying out work on the device or power supply. In so doing, take all the circuit breakers into account, which support dangerous voltages to the device and or load.

Danger of electric shock. The actuator is not suitable for disconnection from supply voltage.

For parallel connection of several drives to an output it is indispensable to observe the corresponding instructions of the manufacturers. There is otherwise risk of irreparable damage to the drives.

Use only drive motors with mechanical or electronic limit switches. Check the limit switches for correct adjustment. Observe the specifications of the motor manufacturers. Device can be damaged.

Danger of electric shock. Do not connect mains voltage and SELV/PELV circuits together to the outputs of the actuator.

Do not connect any three-phase motors. Device can be damaged.

Danger of electric shock. Make sure during the installation that there is always sufficient insulation between the mains voltage and the bus. A minimum distance of at least 4 mm must be maintained between bus conductors and mains voltage cores.

Do not open device or operate it beyond the technical specification.

2.2 Device components

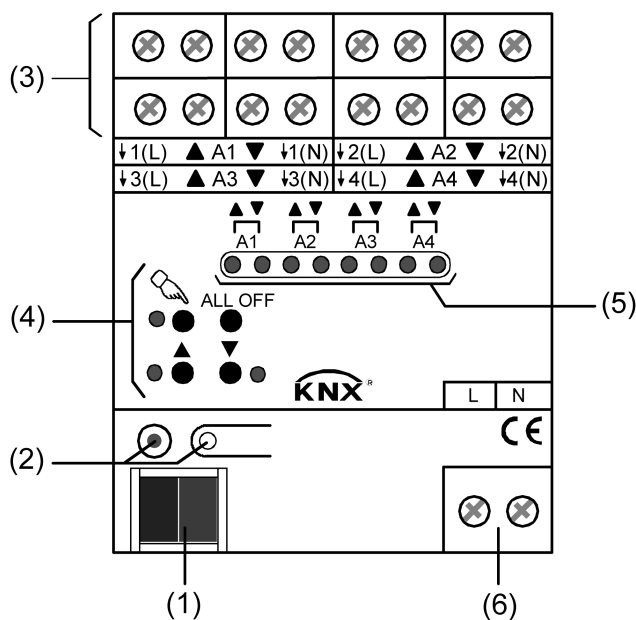

Figure 1: Device components

- (1) KNX bus connection
- (2) Programming button and programming LED (red).
- (3) Screw terminal for connection of the motors.
- (4) Button field for manual control
- (5) Status LED of the outputs with direction display (2 LEDs for each output):
 - LED off: output switched off
 - LED on: Output switched on (movement up "▲" or movement down "▼")
 - LED flashing slowly: output in manual control
 - LED flashing quickly: output blocked by manual control
- (6) Mains voltage terminal for power supply to the device electronics.

2.3 Fitting and electrical connection



DANGER!

Electrical shock when live parts are touched.

Electrical shocks can be fatal.

Before working on the device, disconnect the power supply and cover up live parts in the working environment.



CAUTION!

Danger of destruction if several motors are connected in parallel to one output.

Limit switch contacts can weld together and motors, blinds/shutters and the actuator can be destroyed.

Observe the manufacturer's instructions. Use cutoff relay if necessary!

Fitting the device

- Fit the device by snapping it onto a mounting rail in acc. with EN 60715. The screw terminals for connection of the motors should be at the top



A KNX data rail is not required.



Observe the temperature range (see chapter 3. Technical data) and ensure sufficient cooling, if necessary.

Connecting the power supply for the device electronics

- Connect the bus (standard bus terminal) and the mains voltage as shown in the connection diagram (figure 2).

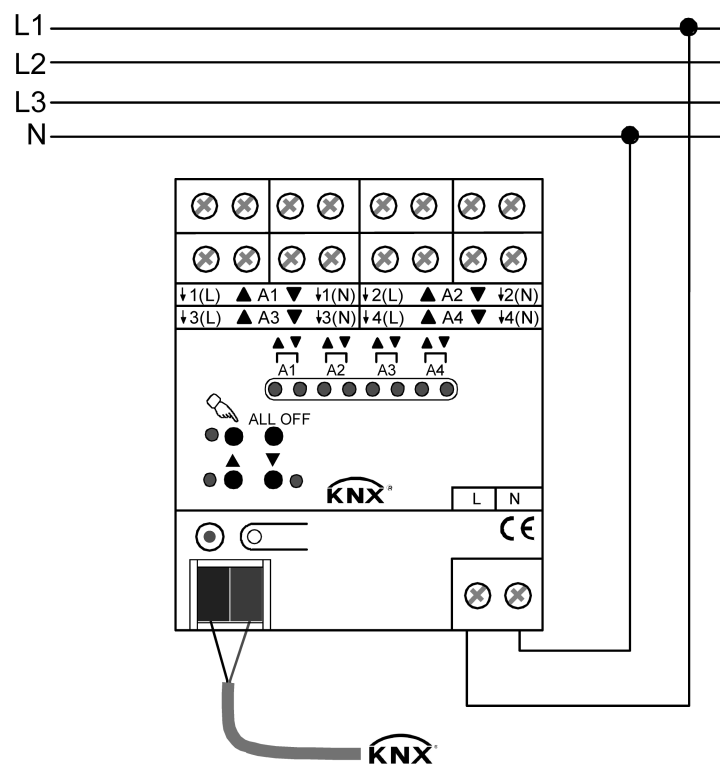

Figure 2: Electrical connection of mains voltage and bus cable

- i** The device can be used with different phase conductors (L1, L2, L3).
- i** For actuation of the outputs – even in manual control mode – the mains supply must be on. The power supply for the device electronics (BCU with application program) is drawn from the bus voltage or from the mains voltage.

Connect device for 230 V drive motors

- Connect the drives as shown in the wiring example (figure 3).

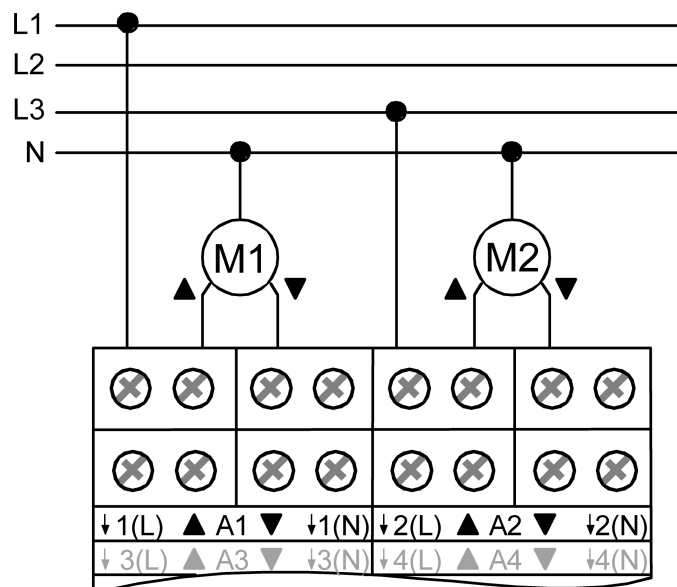

Figure 3: Electrical connection for 230 V drives

- i** Note permitted loads (see chapter 3. Technical data).
- i** The device can be used with different phase conductors (L1, L2, L3).
- i** It is not absolutely necessary to connect the N conductor to the output terminals of the actuator. If, however, drive motors with high-resistant travel direction inputs (e.g. drives with electronic limit switches) are connected, it is necessary to connect the N conductor to the affected terminal of the actuator. The data of the drive manufacturer should be observed.
If the N conductor is connected and the affected output is energised for a long period without an interruption through retriggering, then this may cause unpermitted heating of the actuator. Observe maximum duty cycle (ED) (see chapter 3. Technical data).
- i** The N conductor connections do not provide any N potential for other loads in the distributor.

Installing / removing the protective cap

To protect the bus lines against hazardous voltages, especially in the area of the connecting terminals, a protective cap can be installed.

The cap is installed with the bus terminal in place and the connected bus line led out at the rear.

- To install the cap: slide the cap over the bus connecting terminal until you feel it engage (figure 4).
- To remove the cap: Remove the cap by pressing the sides slightly and by pulling it out to the front.

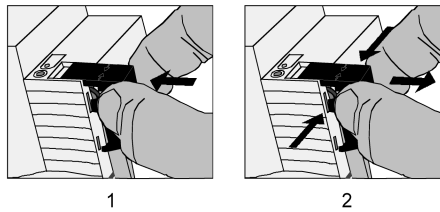

Figure 4: Installing / removing the protective cap for the bus connection

2.4 Commissioning

After installation of the actuator and connection of the bus line, the power supply and of all electrical drives, the device can be put into operation. The following procedure is generally recommended...



DANGER!

Electrical shock when live parts are touched.

Electrical shocks can be fatal.

Before working on the device, disconnect the power supply and cover up live parts in the working environment.

Measuring the travelling times

The actuator needs the exact data for the maximum travelling time in order to position the hanging of blinds/shutters or awnings.

Switch on the mains supply.

- If not yet done, move the blind/shutter into the upper end position.
Upper end position reached.
- Start the measuring time and move the blind/shutter by manual control into the lower end position.
- Stop the time measurement when the lower limit position is reached.
- Enter the measured value in the ETS.

i It is wise to perform several time measurements and to take the average of these values.

i The travelling time can also be determined after commissioning with the ETS (bus operation).

Measuring the travelling time extension

When travelling upwards, shutters have a tendency of moving more slowly due to their own weight or to external physical influences (e.g. temperature, wind, etc.). Even with awnings, the retraction can last longer compared to the extension.

For this reason, the actuator takes the parameterized travelling time extension into account when moving upwards (long-time operation, positioning). The extension is computed as a percentage of the difference of the travelling times in both directions.

The blind/shutter must be in the lower end position. Switch on the mains supply.

- If not yet done, move the blind/shutter into the lower end position.
Lower end position reached.
- Start the measuring time and move the blind/shutter by manual control into the upper end position.
- Stop the time measurement when the upper limit position is reached.
- Express the measured value as a percentage of the determined blind/shutter travelling time and enter the value in the ETS.

i It is wise to perform several time measurements and to take the average of these values.

i The travelling time extension can also be determined after commissioning with the ETS (bus operation).

Commissioning with the ETS

- Switch on the bus voltage
Check: When the programming button is pressed, the red programming LED must light up.
- Download the physical address and the application data with the ETS.

- i** When the mains supply is on, the outputs of the actuator can be switched manually even if there is no bus voltage or if the actuator is not yet programmed. Due to this feature, the drives connected to the individual outputs can be checked for proper functioning already during site operation.

Performing a reference movement (optional)

The actuator can only approach the predefined blind/shutter positions when the actual positions are known. For this purpose, each output must be given the opportunity to synchronise itself whenever the supply voltage is switched on or after every ETS programming operation (physical address, application program, partial download). This synchronisation is performed by means of the reference movement.

Switch on the mains supply.

- If not yet done, move the blinds/shutters into the upper end position.
- Wait until the output relay has switched off (not only the limit switch of the drive).

The reference movement is terminated.

- i** The actuator saves the blind/shutter positions non-volatile. After each supply voltage failure (failure of the bus voltage and of the mains voltage) or after programming with the ETS, the actuator therefore automatically performs a reference travel for each output before a new position can be approached.
- i** After bus voltage return, the actuator generates an "invalid position" message for each output which can also be transmitted to the bus, if so parameterized. The message is withdrawn (inverted signal value) as soon as a reference movement could be executed.

2.5 Operation

All outputs of the actuator can also be operated manually. The button field with 4 function keys and 3 status LEDs on the front panel of the device can be used for setting the following modes of operation...

- Bus control: operation from touch sensors or other bus devices
- Temporary manual control: manual control locally with keypad, automatic return to bus control,
- Permanent manual control: local manual control with keypad.

- i** The operating modes can be enabled or disabled by parameter settings in the ETS.
- i** When manual control is active, the outputs cannot be controlled via the bus.
- i** Manual control is possible only while the actuator is supplied with power from the mains. The manual control mode ends in case of bus voltage return or mains voltage failure.
- i** In manual mode, bus operation can be disabled via a telegram. Manual control is terminated on activation of the disabling function.
- i** Further details concerning the manual mode, especially with respect to the possible parameter settings and the interaction with other functions of the actuator can be found in chapter "Software description" of the present documentation.

Controls and indicators for manual control

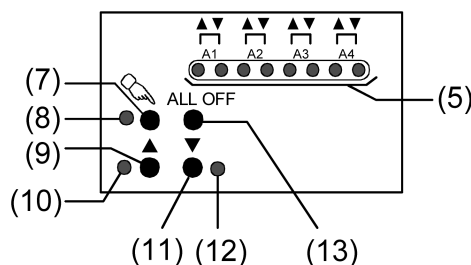

Figure 5: Controls and indicators for manual control on the front panel of the device.

- (5) Status LEDs ▲▼: indicate the state of the individual outputs. One of the LEDs is lit up during an active travel movement in the corresponding direction initiated by bus or by manual control. One of the LEDs flashes when the corresponding output has been selected in manual control. One of the LEDs flashes fast when the corresponding output has been disabled during manual control.
- (7) Key : Activation / deactivation of manual control
- (8) LED : indicates permanent manual control.
- (9) Key ▲: Sustained press: upward travel output (long-time operation) / brief press: output stop.
- (10) Status LED ▲: indicates an active travel movement in the manual mode (up).
- (11) Key ▼: Sustained press: downward travel output (long-time operation)/ brief press: output stop.
- (12) Status LED ▼: indicates an active travel movement in the manual mode (down).
- (13) Key ALL OFF stop all drives (only in permanent manual control).



Priorities

The actuator distinguishes between different functions that can have an effect on an output. In order to prevent conflicting output states, each available function has a certain priority. The function with the higher priority overrides the function with the lower priority.

- 1st priority: manual control (highest priority),
- 2nd priority: safety function(s),
- 3rd priority: direct operation via the bus (short time/long time operation, positioning).

Switching on the temporary manual control

Manual control is enabled in the ETS.

- Press the  key briefly (< 1 s).
The two status LEDs of A1 are flashing (LED  remains off)

 After 5 s without a key-press, the actuator returns automatically to bus operation.

Deactivating temporary manual control

Temporary manual control was activated.

- No key-press for 5 s

- or -

- Select all outputs one after another by a brief press of the key. Thereafter, press the key once again.



- or -

- Switch the mains power supply off or reset the bus (bus voltage return). Temporary manual control is terminated. The Status LEDs A1...max. A4 display the status according to bus operation when mains voltage is switched on.

 The state set via manual control is not changed when temporary manual control is switched off. If, however, a safety function was activated via the bus or during the manual control, the actuator performs the safety reaction for the outputs affected.

Switching on permanent manual control

Manual control is enabled in the ETS. Bus operation or temporary manual control is active.

- Press the  button for at least 5 s.
The status LED  is illuminated. The two status LEDs of A1 are flashing. Permanent manual control is active.

Deactivating permanent manual control

Permanent manual control is active.

- Press the  key for at least 5 s.

- or -

- Select all outputs one after another by a brief press of the key. Thereafter, press the key once again.

- or -

- Switch the mains power supply off or reset the bus (bus voltage return). The status LED  goes out. The Status LEDs A1...max. A4 display the status according to bus operation when mains voltage is switched on.

- i** Depending on the parameterization of the actuator in the ETS, the outputs will be set to the state last adjusted in the manual mode or to the state internally tracked (direct operation, safety reaction) when the permanent manual mode is switched off.

Controlling an output manually

Manual control (permanent or temporary) is activated.

- Select the desired output: Press the  key briefly (if necessary, repeatedly).
The Status LEDs of the selected output A1...max. A4 flash. If the selected output is active controlling a travel movement, the "▲" or "▼" status LEDs on the keypad are lit up additionally.
- Operate the output by pressing the ▲ button or ▼ button.
Short: Stop drive.
Long: Move drive up/down (long time operation).
The selected drive motor executes the corresponding commands immediately.

Shutting off all outputs (stopping all drives)

Permanent manual control is active.

- Press the ALL OFF button
All outputs are shut off immediately (stop). The outputs are not locked. Individual activation is again possible after shutoff.

- i** The "ALL-OFF" function is not available in temporary manual control.

Disabling bus control of individual outputs manually

Permanent manual control is active.

Disabling of the bus control mode must have been enabled in the ETS.

- Select the output: Press the  key briefly (if necessary, repeatedly).
The Status LEDs of the selected output A1...max. A4 flash. If the selected output is active controlling a drive movement, the "▲" or "▼" status LEDs on the keypad are lit up additionally.
- Press the ▲ and the ▼ key simultaneously for at least 5 s.
The appropriate output is locked (control via the bus not possible). The Status LEDs of the selected output A1...max. A4 flash rapidly.

- i** To unlock, proceed in the same way.

- i** An output that has been disabled in manual control can thereafter only be operated in permanent manual control.

3 Technical data

General

Mark of approval	KNX / EIB / VDE
Ambient temperature	-5 ... +45 °C
Storage/transport temperature	-25 ... +70 °C
Installation position	as desired (preferably top output terminals)
Minimum distances	none
Fixing type	Snapping onto top hat rails in closed housing (e.g. small distribution board, etc.)
Fitting width	72 mm / 4 modules
Weight	approx. 300 g

Terminals for mains supply and outputs

Connection mode	Screw terminal
Single stranded	0.5 ... 4 mm ²
finely stranded without conductor sleeve	0.34 ... 4 mm ²
finely stranded with conductor sleeve	0.14 ... 2.5 mm ²
Connection torque	max. 0.8 Nm

KNX supply

KNX medium	TP 1
Commissioning mode	S-mode
Rated voltage KNX	DC 21 ... 32 V SELV
Power consumption KNX	typical 150 mW
Connection mode KNX	Standard terminal

External supply

Rated voltage	AC 230 / 240 V ~
Mains frequency	50 / 60 Hz
Power consumption	max. 5.6 VA
Power loss	max. 4.5 W

Outputs

Contact type	μ contact, monostable
Mains frequency	50 / 60 Hz
Switching voltage	AC 250 V ~
Switching current AC 250 V	AC 6 A
Minimum switching current AC	100 mA
Blind/shutter travelling time	max. 20 min
Duty cycle	max. 50% (cycle time ≤ 40 min)

4 Software description

4.1 Software specification

ETS search paths: - Shutter / Shutter / Shutter actuator 4-gang AC 230 V SE

BAU used: TPUART + μ C
 KNX/EIB type class: 3b device with cert. Physical layer + stack
 Configuration: S-mode standard
 PEI type: "00"_{Hex} / "0"_{Dec}
 PEI connector: No connector

Applications:

No.	Short description	Name	Version	from mask version
1	Multi-functional application for the shutter and awning control with separately configurable travelling times, extended feedback functions and assignment options for up to 5 different safety functions. Moreover, the preferred states of the relays in case of bus voltage failure or bus / mains voltage return and after ETS programming can be preset separately.	Shutter 20CD11	1.1 for ETS3.0 Version d onwards and ETS 4.0	705

4.2 Software "Shutter 20CD11"

4.2.1 Scope of functions

- 4-channel operation for direct connection of four 230 V AC drive motors.
- Control of shutters or awnings.
- Behaviour in case of bus voltage failure and bus voltage return as well as after ETS programming presettable for each output.
- Active feedback telegrams can be globally delayed after bus voltage return.
- Manual control of outputs independent of the bus (for instance, building site operation) with LED status indicators.
- Each output offers the full scope of functions without any restrictions. All channel-oriented functions can be parameterized separately for each output. This feature permits independent and multi-functional control of the outputs.
- Separately configurable blind travelling times with travelling time extension for moves into the upper end position.
- Travel direction change-over time and the times for short and long-time operation presettable.
- Blind/shutter feedback telegram (only with bus control). In addition, an invalid blind/shutter position can be reported back. Active (transmitting after changes) or passive (object readout) feedback functions.
- Assigning of outputs to up to 5 different safety functions (3 wind alarms, 1 rain alarm, 1 frost alarm) optionally with cyclical monitoring. The safety functions (objects, cycle times, priority) are programmed device-oriented and in common for all outputs. The assignment of individual outputs to the safety functions and the safety measures can be parameterized for each channel.

4.2.2 Notes on software

ETS project design and commissioning

For configuration and commissioning of the device, ETS3.0 from Version "d" Patch "A" onwards or ETS4.0 is required. Using these ETS versions or later versions will result in benefits with regard to the programming. The necessary product database is offered in the *.VD4 format.

Safe-state mode

If the device does not work properly - for instance as a result of errors in the project design or during commissioning - the execution of the loaded application program can be halted by activating the safe-state mode. The safe-state mode does not permit controlling the outputs via the bus and by hand. The actuator remains passive since the application program is not being executed (state-of-execution: terminated). Only the system software is still functional so that the ETS diagnosis functions and also programming of the device continue to be possible.

Activating the safe-state mode

- Shut off the bus and the mains voltage supply.
- Press and hold down the programming button.
- Switch on the bus or mains voltage. Release the programming button only after the programming LED starts flashing slowly.

The safe-state mode is activated. With a new brief press of the programming button, the programming mode can be switched on and off as usual also in the safe-state mode. The programming LED will nevertheless continue to flash independently of the programming mode as long as the safe-state mode is active.

- i The safe-state mode can be terminated by switching off the supply voltage (bus or mains) or by programming with the ETS.

Unloading the application program

The application program can be unloaded with the ETS. In this case, manual control as part of the application program is not available either.

4.2.3 Object table

Number of communication objects:	27 (max. object number 106 - gaps in between)
Number of addresses (max):	254
Number of assignments (max):	255
Dynamic table management	No
Maximum table length	255

Channel-independent objects

Function: Manual operation

Object	Function	Name	Type	DPT	Flag
 ⁰	Disabling	Manual operation	1-bit	1.003	C, W, -, (R) ₁

Description 1-bit object for disabling the buttons for manual control on the device. The polarity can be configured.

Function: Manual operation

Object	Function	Name	Type	DPT	Flag
 ¹	Status	Manual operation	1-bit	1.002	C, -, T, (R) ₁

Description 1-bit object for manual control status transmission. The object is "0", when manual control is deactivated (bus control). The object is "1", when manual control is being activated. You can configure whether the temporary or the permanent manual control will be indicated as status information or not.

Function: Safety function

Object	Function	Name	Type	DPT	Flag
 ³	Wind alarm 1	Safety	1-bit	1.005	C, W, -, (R) ₁

Description 1-bit object for central activation or deactivation of the first wind alarm ("0" = wind alarm deactivated / "1" = wind alarm activated).

Function: Safety function

Object	Function	Name	Type	DPT	Flag
 ⁴	Wind alarm 2	Safety	1-bit	1.005	C, W, -, (R) ₁

Description 1-bit object for central activation or deactivation of the second wind alarm ("0" = wind alarm deactivated / "1" = wind alarm activated).

1: Each communication object can be read out. For reading, the R-flag must be set.

Function: Safety function

Object	Function	Name	Type	DPT	Flag
 ⁵	Wind alarm 3	Safety	1-bit	1.005	C, W, -, (R) 1

Description 1-bit object for central activation or deactivation of the third wind alarm ("0" = wind alarm deactivated / "1" = wind alarm activated).

Function: Safety function

Object	Function	Name	Type	DPT	Flag
 ⁶	Rain alarm	Safety	1-bit	1.005	C, W, -, (R) 1

Description 1-bit object for central activation or deactivation of the rain alarm ("0" = rain alarm deactivated / "1" = rain alarm activated).

Function: Safety function

Object	Function	Name	Type	DPT	Flag
 ⁷	Frost alarm	Safety	1-bit	1.005	C, W, -, (R) 1

Description 1-bit object for central activation or deactivation of the frost alarm ("0" = frost alarm deactivated / "1" = frost alarm activated).

Channel-oriented objects

Function: Long-time operation

Object	Function	Name	Type	DPT	Flag
 ^{10, 36, 62, 88}	Long-time operation	Output 1-4	1-bit	1.008	C, W, -, (R) 1

Description 1-bit object for activation of long time operation

Function: Short time operation

Object	Function	Name	Type	DPT	Flag
 ^{11, 37, 63, 89}	Short time operation	Output 1-4	1-bit	1.007	C, W, -, (R) 1

Description 1-bit object for activation of short time operation or for stopping a drive movement.

1: Each communication object can be read out. For reading, the R-flag must be set.

Function: Position feedback

Object	Function	Name	Type	DPT	Flag
 24, 50, 76, 102	Shutter position feedback	Output 1-4	1 byte	5.001	C, -, T, R ^{1,2}

Description 1-byte object for position feedback of the shutter/awning height (0...255).

Function: Position feedback

Object	Function	Name	Type	DPT	Flag
 26, 52, 78, 104	Invalid position feedback	Output 1-4	1-bit	1.002	C, -, T, R ^{1,2}

Description 1-bit object for the feedback of an invalid shutter/awning height ("0" = Position valid / "1" = Position invalid).

Function: Presetting the position

Object	Function	Name	Type	DPT	Flag
 28, 54, 80, 106	Shutter/awning position	Output 1-4	1 byte	5.001	C, W, -, (R) 1

Description 1-byte object for presetting a position value (0...255) with direct control for the shutter/awning height.

1: Each communication object can be read out. For reading, the R-flag must be set.

2: Depending on the configuration, feedback objects are either actively transmitting (T flag set) or passively readable (R flag set).

4.2.4 Functional description

4.2.4.1 Description of channel-independent functions

Manual operation

All outputs of the actuator can also be operated manually. The button field with 4 function keys and 3 status LEDs on the front panel of the device can be used for setting the following modes of operation...

- Bus control: operation from touch sensors or other bus devices
- Temporary manual control: manual control locally with keypad, automatic return to bus control,
- Permanent manual control: local manual control with keypad.

The operation of the function keys, the control of the outputs and the status display are described in detail in chapter "Operation" (see page 11).

The parameterisation, status feedback, disabling via a bus telegram, and interaction with other functions of the actuator when manual control is activated and deactivated are described in greater detail below.

Manual control is only possible when the mains voltage is on. In the state of the actuator as supplied, manual control mode is fully enabled. In this unprogrammed state, the individual outputs can be switched on and off also without bus voltage so that fast function checking of the connected drives (e.g. on the construction site) is possible.

After initial commissioning of the actuator via the ETS, manual control can be enabled or disabled separately for various states of operation. Manual control can, for instance, be disabled during bus operation (bus voltage applied). Another option consists in the complete disabling of the manual control only in case of bus voltage failure. Therefore manual control can be disabled completely, if the bus disable and bus failure disable are active.

Enabling the manual control mode

Manual control for the different states of operation is enabled or disabled by means of the parameters "Manual control in case of bus voltage failure" and "Manual control during bus operation".

- Set the parameter "Manual control in case of bus voltage failure" to "enabled".
Manual control is then basically enabled when the bus voltage is off. This setting corresponds to the setting of the actuator as delivered.
 - Set the parameter "Manual control in case of bus voltage failure" to "disabled".
Manual control is completely disabled when the bus voltage is off. In this case, bus operation is not possible either so that the outputs of the actuator can no longer be activated.
- i** In the configuration "Manual control in case of bus voltage failure = disabled", a bus voltage failure does not terminate a previously activated manual control. In this case, the parameter configuration only takes effect when the manual control is terminated by pressing a button on the device. After that the manual control cannot be activated as long as the bus voltage is switched off.
- Set the parameter "Manual control during bus operation" to "enabled".
Manual control is then basically enabled when the bus voltage is on. The outputs of the actuator can be activated via the bus or manually. This setting corresponds to the setting of the actuator as delivered.
 - Set the parameter "Manual control during bus operation" to "disabled".
Manual control is completely disabled when the bus voltage is on. In this configuration, the actuator outputs can only be operated via the bus.

- i** Further parameters and communication objects of the manual control are visible only in the configuration "Manual control during bus operation = enabled". For this reason, the disabling function, the status message and bus control disabling can only be configured in the above parameter setting.

Presetting the behaviour at the beginning and at the end of manual control.

The manual control distinguishes the temporary and permanent manual control. The behaviour is different depending on these modes of operation, especially at the end of manual control. It should be noted that the operation via the bus, i.e. control of the outputs by direct operation or by the safety functions is always disabled when the manual control is active. This means that the manual control mode has the highest priority.

Behaviour at the beginning of manual control:

The behaviour at the beginning of manual control does not differ for temporary and permanent manual control. When manual control is activated, all travel movements that were started beforehand by bus control will still be completed unless the travel movement in question is stopped by hand.

An active safety function can be overridden by the manual control. This function will be reactivated after deactivation of the manual control mode, as long as it has not yet been reversed.

Behaviour at the end of manual control:

The behaviour at the end of manual control is different for temporary and permanent manual control.

The temporary manual mode is shut off automatically when the last output has been addressed and when the select key is pressed once more. During a deactivation of the temporary manual control mode, the actuator goes back to 'normal' bus operation and does not change the state selected by manual control. If, however, a safety function was activated via the bus before or during the manual control, the actuator performs this higher prioritised function again.

The permanent manual control mode is shut off, when the select key is pressed for more than 5 s. Depending on the parameterization of the actuator in the ETS, the outputs will be set to the state last adjusted in the manual mode or to the state internally tracked (direct operation, safety reaction) when the permanent manual mode is switched off. The parameter "Behaviour at the end of permanent manual control during bus operation" defines the corresponding reaction.

- Set the parameter "Behaviour at the end of permanent manual control during bus operation" to "no change".

All telegrams received during an active permanent manual control mode for direct operation (long-time/short-time, positioning) will be rejected. After the end of the permanent manual control mode, the current state of all outputs remains unchanged. If, however, a safety function was activated via the bus before or during the manual control, the actuator performs these higher prioritised functions again.

- Set the parameter "Behaviour at the end of permanent manual control during bus operation" to "track outputs".

During an active permanent manual control all incoming telegrams (short-time telegrams excepted) are internally tracked. At the end of the manual control mode, the outputs will be set to the tracked states or to the absolute positions last set before the permanent manual control mode. A long-time operation is not tracked when the output is already in the corresponding end position.

- i** The behaviour at the end of the permanent manual control when the bus voltage is off (only manual control) is permanently set to "no change".
- i** The control operations triggered in the manual control mode will be transmitted via feedback objects to the bus, if enabled and actively transmitting.

- i** On return of bus voltage or after programming with the ETS an activated manual control mode will always be terminated. In this case, the parameterized or predefined behaviour at the end of manual control will not be executed. The actuator executes the parameterized behaviour on bus voltage return or after ETS programming instead.

Presetting a manual control disable

The manual control mode can be separately disabled via the bus, even if it is already active. If the disabling function is enabled, then as soon as a disabling telegram is received via the disabling object of the manual control, the actuator immediately terminates an activated manual control and locks the function keys on the front panel of the device. The telegram polarity of the disabling object is parameterisable.

The manual control mode during bus operation must be enabled.

- Set the parameter "Disabling function ?" on parameter page "Manual control" to "yes".
The disabling function of the manual control mode is enabled and the disabling object is visible.
- Select the desired telegram polarity in the "Disabling object polarity" parameter.
- i** If the polarity is "0 = disabled; 1 = enabled", the disabling function is immediately active on return of bus voltage or after an ETS programming operation (object value "0"). To activate the manual control in this case, an enable telegram "1" must first be sent to the disabling object.
- i** In case of bus voltage failure, disabling via the disabling object is always inactive (depending on parameterization, the manual control is then either enabled or completely disabled). After return of bus voltage a disabled state that was active before will be reactivated. The disabled state will be deactivated only after an enabling telegram has been received. In the event of failure of the supply voltage (bus voltage and mains voltage failure) the disable is deactivated via the disabling object. An interruption of the mains supply alone has no effect on the disabled state of the manual control.
- i** When an active manual control is terminated by a disable, the actuator will also transmit a "Manual control inactive" status telegram to the bus, if the status messaging function is enabled.

Presetting the status message function for the manual control mode

The actuator can transmit a status message to the bus via a separate object when the manual control is activated or deactivated. The status telegram can only be transmitted when the bus voltage is present. The polarity of the status telegram can be parameterised.

The manual control mode during bus operation must be enabled.

- Set the parameter "Transmit status ?" on parameter page "Manual control" to "yes".
The status messaging function of manual control is enabled and the status object is visible.
- Specify in the parameter "Status object function and polarity" whether the status telegram is generally a "1" telegram whenever the manual control mode is activated or only in those cases where the permanent manual mode is activated.
- i** The status object is always "0" when the manual control mode is deactivated.
- i** The status is only transmitted actively to the bus ("0") after return of bus voltage when an activated manual control is ended by the bus return during the bus voltage failure. The status telegram is in this case transmitted without delay. After bus voltage return or after programming with the ETS, the value of the status object is "0" and can also be read out.
- i** When an active manual control is terminated by a disable, the actuator will also transmit a "Manual control inactive" status telegram to the bus.

Setting disabling of the bus control

Individual outputs can be disabled locally, so that the disabled outputs can no longer be controlled via the bus. Such disabling of the bus operation is initiated by operation in permanent manual control and is indicated by rapid flashing of the status LEDs of the outputs concerned. The disabled outputs can then only be activated in permanent manual control.

The manual control mode during bus operation must be enabled.

- Set the parameter "Disable bus control of individual outputs during bus operation" on parameter page "Manual control" to "yes".

The function for disabling the bus control is enabled and can be activated locally. As an alternative, this parameter can be set to "no" to prevent activation of disabling of the bus control in permanent manual control.

- i** The disabling initiated locally has the highest priority. Thus all other functions of the actuator that can be activated via the bus (e.g. safety function) are overridden. During activation of the disabling and subsequent deactivation of the permanent manual control, depending on the parameterization of the actuator in the ETS, the outputs will be set to the state last adjusted in the manual mode or to the state internally tracked (direct operation, safety reaction) when the permanent manual mode is switched off.
- i** Any disabling of the bus control activated locally is not reset in case of bus voltage failure or return. Even a mains voltage failure does not by itself reset the disabling. A failure of the supply voltage (bus and mains voltage failure) does deactivate the disabling of the bus control.

Safety functions:

The actuator can handle up to five different safety functions. Each safety function has a communication object of its own so that the functions can be activated or deactivated independently of one another.

There are three different wind alarms available. These alarms can be used, for instance, to protect shutters or awnings on several building facades from wind and gusts. Additionally or alternatively, a rain alarm and frost alarm can be enabled and used in order to avoid mechanical destruction of extended awnings at low temperatures, for example. The telegram polarity of the safety objects is fixed: "0" = No alarm / "1" = Alarm.

Usually, weather stations, which record temperature, wind speed and rain via the sensors, control the communication objects of the safety function.

The safety functions are programmed and configured in common for all outputs. The different outputs of the actuator can be separately assigned to all or to individual safety functions. Only assigned outputs respond to a change in the state of the safety objects. The reactions at the beginning of an alarm message ("1" telegram) or at the end of an alarm message ("0" telegram) can be parameterized for each channel.

Because outputs are also assigned to multiple safety alarms, the priority of incoming alarm messages can be preset for several channels. Thus, the three wind alarms have the same priority with respect to one another (logic OR). The order of priority of the wind alarms with respect to the frost alarm or to the rain alarm can be parameterized.

The communication objects for the safety alarms can be monitored for the arrival of cyclical telegrams. If there are no telegrams within a settable monitoring time, the device activates the safety movement for the output. The safety function is terminated as soon as a new "0" telegram is received.

For the wind alarms, the rain alarm and the frost alarm, different monitoring times between '1 minute' and '23 hours 59 minutes' can be separately selected in the ETS. A shared time is configured for the wind alarms. Each wind alarm has its own timer so that the wind objects are separately checked for telegram updates.

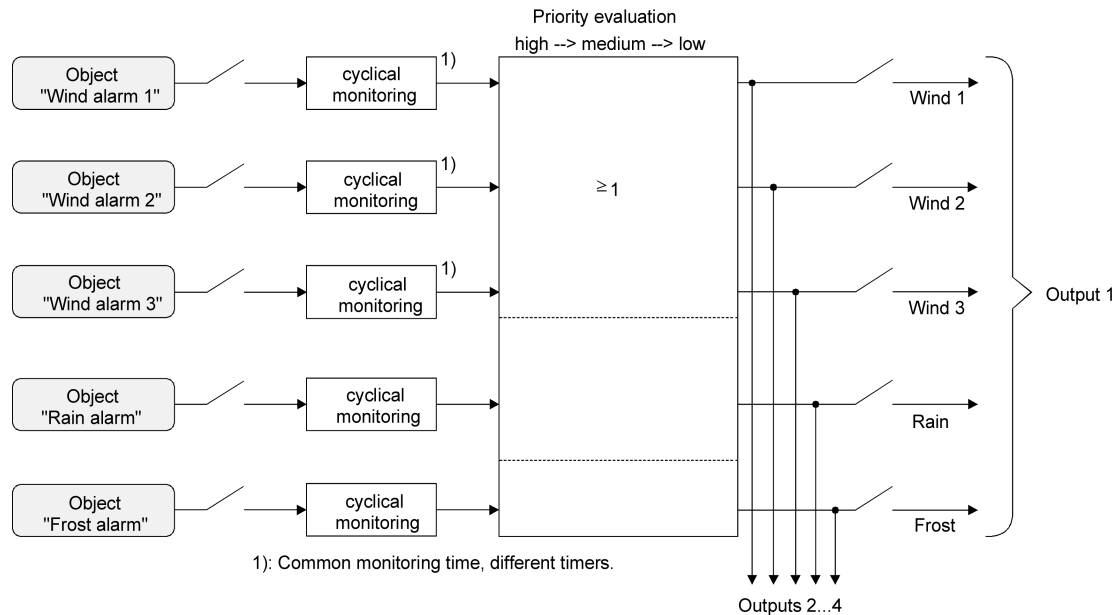

Figure 6: Function diagram of safety functions

Enabling the safety functions

The safety functions must first be globally enabled before they can be parameterized and used. After global enabling, the individual safety alarms can be enabled or disabled independently of one another.

- Set the parameter "Safety functions" on the "Safety" parameter page to "enabled".
The safety functions are globally enabled and the other parameters and the parameter page "Safety times" become visible.
- Set the parameters "Wind alarm 1", "Wind alarm 2", "Wind alarm 3", "Rain alarm" and "Frost alarm" depending on functional requirements to "enabled". The "disabled" option deactivates the corresponding alarm.

The necessary safety alarms are now enabled. The safety objects are visible and can be linked with group addresses.

- i** It should be noted that the channel-oriented assignment of the outputs to the safety alarms (on parameter pages "Ax – Safety"; x = number of output) is operational only after the corresponding alarm has been enabled. Otherwise, an assignment is without function.
- i** An update of the safety objects ("ON" to "ON" or "OFF" to "OFF") shows no reaction.
- i** After failure of the supply voltage (bus and mains voltage failure) or after programming with the ETS, the safety functions are always deactivated. If only the mains voltage or only the bus voltage fails, the object states of the safety functions are not lost and the functions remain activated, if they were activated before. In this case, it should be noted, however, that the configured behaviour will be executed after bus or mains voltage return parameter "Behaviour after bus or mains voltage return"). After such action, the outputs are, however, safety-locked and cannot be operated via the bus anymore unless the safety functions assigned are terminated.

Presetting the safety priorities

If several safety alarms are assigned to an output, it is important to preset the priority of the incoming safety telegrams. In so doing, an alarm with a higher priority overrides the alarms with the lower priorities. When safety alarm with the higher priority has ended, the safety alarm with the lower priority is executed on condition that it is active.

The safety functions must have been globally enabled.

- Arrange the "Priority of safety alarms" parameters on the "Safety" parameter page in the required order of priority.
- ❗ The three wind alarms have the same priority with respect to one another (logic OR). The last telegram update to the wind alarm objects decides which of the wind alarms will be executed. The wind alarm is completely deactivated for an assigned output only after all three objects are inactive ("0").

Presetting cyclical monitoring

If cyclical telegram monitoring of the safety objects is necessary, the individual monitoring functions must be activated separately. The monitoring functions must be enabled and the monitoring times preset on the "Safety times" parameter page.

The safety functions must have been globally enabled.

- If monitoring of the wind alarms is to be activated, the parameter "Use wind alarm monitoring function ?" must be set to "yes".
The monitoring function for the wind alarm objects is now activated. As soon as the monitoring function is activated, telegrams must be transmitted cyclically to all enabled wind alarm objects. If only one of the wind alarm telegrams is missing within the monitoring period, the wind alarm reaction will be executed for the output concerned.
- Specify the required monitoring time for the wind alarm objects in the "Wind alarm monitoring times" parameters.
- If the monitoring function is to be activated for a rain alarm, the parameter "Use rain alarm monitoring function ?" must be set to "yes".
The monitoring function for the rain alarm object is now activated. As soon as the monitoring function is activated, telegrams must be transmitted cyclically to the rain alarm object.
- Specify the required monitoring time for the rain alarm object in the "Rain alarm monitoring times" parameters.
- If the monitoring function is to be activated for a frost alarm, the parameter "Use frost alarm monitoring function ?" must be set to "yes".
The monitoring function for the frost alarm object is now activated. As soon as the monitoring function is activated, telegrams must be transmitted cyclically to the frost alarm object.
- Specify the required monitoring time for the frost alarm object in the "Frost alarm monitoring times" parameters.
- ❗ The monitoring function for the wind alarms may only be activated, if at least one wind alarm has been activated on the "Safety" page.
- ❗ The cycle time of the transmitters should be shorter than the monitoring time parameterized in the blind/shutter actuator in order to ensure that at least one telegram can be received during the monitoring time.

4.2.4.2 Channel-oriented functional description

Behaviour in case of bus voltage failure, after bus or mains voltage return or after programming with the ETS

The preferred relay contact positions in case of bus voltage failure, bus or mains voltage return or after ETS programming can be preset separately for each output. Since the actuator is equipped with mains-dependent monostable relays, the relay switching state at bus voltage failure can be defined as well.

Presetting the behaviour after ETS programming

The parameter "Behaviour after ETS programming" can be preset separately for each output channel on the parameter page "Ax General" (x = number of output). This parameter can be used to configure the relay behaviour of the output irrespective of the behaviour after a bus or mains voltage return.

- Set the parameter to "stop".
After programming with the ETS, the actuator switches the relays of the output to the "stop" position. A drive movement, if any, will be interrupted.
- Set the parameter to "raising".
After programming with the ETS, the actuator raises the blind.
- Set the parameter to "lowering".
After programming with the ETS, the actuator lowers the blind.
- i** At the beginning of each ETS programming cycle, the actuator always executes a "stop" command for all outputs. The manual mode, if active, will be terminated.
- i** The "Behaviour after ETS programming" as parameterized will be executed after every ETS application or parameter download. A simple download of the physical address alone or partial programming of only the group addresses has the effect that this parameter is disregarded and that the parameterized "Behaviour after bus or mains voltage return" will be executed instead.
- i** ETS programming can be performed as soon as the bus voltage is connected to the actuator and switched on. The mains voltage supply is not required for an ETS download. If programming with the ETS was performed with bus voltage only, the parameterized "Behaviour after ETS programming" will only be executed when also the mains voltage supply of the actuator has been switched on. In this case, the "Behaviour after bus or mains voltage return" will not be activated!
This response should be noted especially for actuators that are installed in an electrical installation in a preprogrammed state.
- i** After programming with the ETS, the safety functions are always deactivated.

Presetting the behaviour in case of bus voltage failure

The parameter "Behaviour in case of bus voltage failure" can be preset separately for each output channel under "Ax General" (x = number of output). The parameter defines the behaviour of an output if only the bus voltage fails. The parameterized behaviour will not be adopted, if a manual control mode is active at the time of bus failure (state LEDs blinking in case of temporary or permanent manual control).

- Set the parameter to "stop".
In case of bus voltage failure, the actuator switches the relays of the output to the "stop" position. A drive movement, if any, will be interrupted.
- Set the parameter to "raising".
After bus voltage failure, the actuator raises the blind.
- Set the parameter to "lowering".
After bus voltage failure, the actuator lowers the blind.

- Set the parameter to "position approach".
In case of bus voltage failure, the connected drive can approach a position specified by further parameters (0...100 %). The actuator performs a reference travel before the position approach, if the current position at the time of bus failure is unknown (e.g. due to power supply failure or to previous ETS programming).
- Set the parameter to "no reaction".
In the event of bus voltage failure, the relay of the output shows no reaction. Motions still in progress at the time of failure will still be completed as long as the mains voltage supply is still on.
- i** Safety functions also remain active after a bus voltage failure as long as the mains voltage is still on. These functions will therefore be executed again at the end of a temporary or permanent manual control (if enabled in case of bus failure) even if there is no bus voltage.
- i** When the still ongoing motion or the motion parameterized in case of bus voltage failure has come to an end, the outputs can no longer be activated except by manual control (if the mains voltage is on and if manual control is enabled) or by bus/mains voltage return.
- i** A bus voltage failure will in any case result in a stop of all time functions. Thus, all scene recalls in the delay phase will be aborted and all delay times for sun protection and presence will be ended by ignoring the object value last received and still in the delay phase. A telegram update received shortly before bus voltage failure is then lost, if the corresponding delay has not yet elapsed.
- i** In the event of a mains voltage failure, all relays of the actuator will always drop out ("stop") independent of the bus voltage condition. In this state the outputs can no longer be activated.
- i** In case of bus or mains voltage failure, the current position data of the outputs are permanently saved internally so that these position values can be exactly repositioned after bus or mains voltage return, if this is configured. The data are stored before the reaction parameterized for the case of bus voltage failure takes place and only if one part of the supply (mains or bus) is still present, or if the supply fails completely after the mains voltage has been available before without interruption for at least 20 seconds after the last reset (storage capacitors sufficiently charged for storage purposes). The data will not be stored, if the position data is unknown. The saving process is performed only once after the failure of one part of the supply voltage...

Example 1:

Bus voltage failure -> Data storage -> Then mains voltage failure -> No further data storage,

Example 2:

Mains voltage failure -> Data storage -> Then bus voltage failure -> No further data storage.

The following rules apply for the position data to be stored:

The current blind/shutter positions are saved. Positions temporarily approached will be stored also for those outputs that are involved in a travel movement at the time of data storage. Since the position data is saved in percent (0..100), a small deviation from the positions possibly reported back later after bus or mains voltage return (ranging from 0..255) cannot be avoided.

Because the position data are saved only once in the event of bus voltage failure, positions that are changed after a bus voltage failure, for example via manual control, are not tracked!

In case of ETS programming, the saved position data is not lost.

Behaviour after bus or mains voltage return presetting

The parameter "Behaviour after bus or mains voltage return" can be preset separately for each output channel on the parameter page "Ax – General"(x = number of output).

- Set the parameter to "stop".

In case of bus or mains voltage return, the actuator switches the relays of the output to the "stop" position. A drive movement, if any, will be interrupted.

- Set the parameter to "raising".
After bus or mains voltage return, the actuator raises the curtain.
 - Set the parameter to "lowering".
After bus or mains voltage return, the actuator lowers the curtain.
 - Set the parameter to "position during bus / mains failure".
After bus or mains voltage return, the position value last existing and internally stored before bus or mains voltage failure will be tracked. The actuator performs a reference travel before the position approach, if the current position at the time of bus or mains voltage return is unknown (e.g. due to complete power supply failure or to previous ETS programming).
 - Set the parameter to "position approach".
After bus or mains voltage return, the connected drive can travel to a position (0...100 %) specified by other parameters. The actuator performs a reference travel before the position approach, if the current position at the time of bus or mains voltage return is unknown (e.g. due to complete power supply failure or to previous ETS programming).
 - Set the parameter to "no reaction".
In the event of bus or mains voltage return, the relay of the output shows no reaction. Any movements still in progress at the instant when voltage returns will still be completely finished.
- i** "Position during bus / mains failure" setting: If no position values could be stored in case of bus or mains voltage failure because the position data were unknown (no reference travel executed), the actuator shows no reaction with this parameterization either.
- i** "No reaction" setting: The commands received via the bus during a mains voltage failure (bus voltage present) are tracked when the mains voltage returns. Interrupted short- or long-time travel movements – if not completed – are restarted at full length and position approaches are continued from the break point.
- i** The parameterized behaviour is always executed independent of the current states of the safety functions. Safety functions can nonetheless be active even after bus or mains voltage return, if these functions have been activated before a bus voltage failure or before or during a mains voltage failure. Any direct operation can thus be overridden. Only in the case of a complete power supply failure (bus and mains voltage failure) are the safety functions deactivated, too.
- i** After return of bus voltage a manual control will be interrupted.. In case of mains failure, no manual control is possible.
- i** The device only executed the configured "Behaviour after bus or mains voltage return" if the last ETS programming of the application of the parameters ended at least approx. 20 s prior to switching on bus and mains voltage. Otherwise ($T_{ETS} < 20$ s) the "Behaviour after ETS-programming" will also be performed after Bus/mains return. If just the bus or mains voltage fails and is switched on again after an ETS download, the actuator performs the "Behaviour after bus or mains voltage return".

Determining and configuring short-time and long-time operation

The short-time operation allows you to set the 'slot position' of a shutter or the gradual adjustment of an awning. In most cases, short-time operation is activated by pressing a pushbutton sensor permitting manual intervention in the blind controller. If the actuator receives a short-time command during a movement of the shutter or awning, the actuator stops the drive movement immediately.

Long-time operation is determined by the travelling time of the connected shutter or awning and must therefore not be preset separately. The travelling time must be determined and entered in the parameters of the ETS. The control of an output by means of a long-time or a short-time telegram is also designated as 'direct operation'.

To ensure that the curtain has definitely reached its end position at the end of long-time operation, the actuator always prolongs the long-time movement by 20 % of the parameterized travelling time.

The parameterized travelling time extension will moreover be taken into account by the actuator for all upward travels as the drive motors are then generally not so fast due to the weight of the curtains or to external physical influences (e.g. temperature, wind, etc.). Thus, it is ensured that the upper end position is always reached even in case of uninterrupted long time travel movements.

- i** A long time or a short time operation can be retriggered by a new incoming long time or short time telegram.
- i** A travel movement activated in the manual control mode or by a safety function is always a long-time operation. The "raising" or "lowering" commands configured in the ETS will equally activate the long time operation.

Presetting the short time operation

Short-time operation is configured separately for each output and independent of the travelling time of the curtain. It is possible to specify in the ETS whether the output executes only a "stop" for a travel movement on reception of a short time telegram or whether the output is activated for a specific duration.

- Set the parameter "Short time operation" on parameter page "Ax - Time settings" (x = number of output) to "yes".
The actuator activates the output concerned for the time specified under "Duration of short-time operation" when a short-time telegram is received and when the output is not in the process of executing a travel movement. If the output is executing a travel movement at the time of telegram reception, the output will only just stop.
 - Set the parameter "Short time operation" on parameter page "Ax - Time settings" (x = number of output) to "no (only stop)".
The actuator will only stop the output on reception of a short time telegram, if the output is in the process of executing a travel movement. There will be no reaction, if the output is not executing a movement at the time of telegram reception.
- i** The configured "Time for short-time operation" for a shutter should correspond to the complete travelling time for opening a roller shutter.
 - i** The short time operation is always executed without a movement time extension.

Determining and configuring travelling times

For computing positions and also for executing long-time operation, the actuator needs the exact travelling time of the connected shutter or awning. The travelling time must be determined separately for each output and entered into the ETS configuration. It is important to determine the movement time accurately to permit positions to be approached with good precision. Therefore, it is recommended to make several time measurements and to take the average of these values before entering them into the corresponding parameter. The movement time corresponds to the duration of a drive movement from the completely open position (upper end position / awning rolled up) to the completely closed position (lower end position / awning completely unrolled). Not vice-versa!

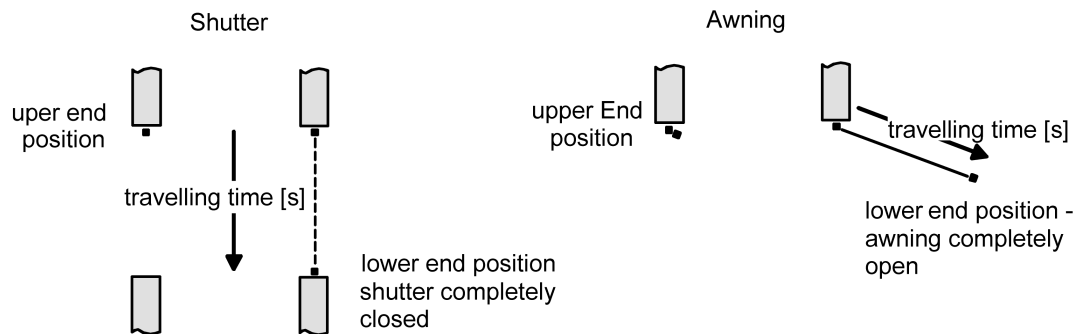

Figure 7: Determining the movement time according to the drive type

Setting the shutter/awning travelling time

The measurement of the movement time is described in detail in chapter "Commissioning" (see page 9).

- Enter the exact travelling times determined in the course of the commissioning procedure into the parameters "Shutter/awning travelling time" on parameter page "Ax – Time settings" (x = number of output). The maximum travelling time is '19 minutes 59 seconds. The working principle does not allow longer movement times.
- i** The parameterized travelling time extension will moreover be taken into account by the actuator for all upward travels or all travel movements into the open position as the drive motors are then generally no so fast due to the weight of the curtains or to external physical influences (e.g. temperature, wind, etc.).

Determining and configuring the movement time extension and the switchover time

When travelling upwards, shutters or awnings have a tendency of moving more slowly due to their own weight or to external physical influences (e.g. temperature, wind, etc.). For this reason, the actuator takes the parameterized travelling time extension into account when moving upwards. The extension is computed as a percentage of the difference of the movement times in both directions.

The movement time extension should be determined separately for each output during commissioning and entered into the ETS configuration. The measurement of the movement time extension is described in detail in chapter "Commissioning" (see page 9).

Example for determining the movement time extension:

- "Movement time" previously determined and configured: $T_{OU} = 20$ seconds,
- Time determined for movement from lower to upper end position: $T_{UO} = 22$ seconds,
- Calculated supplementary travelling time: $T_{UO} - T_{OU} = 2$ seconds -> 2 seconds out of 20 seconds are 10 %,
- Movement time extension to be configured: 10 %.

To protect the drive motors from irreparable damage, a fixed pause during movement direction switch-over can be configured for each output. During the pause, no travel direction is active ("stop"). The necessary parameter value can normally be found in the technical documents of the drive motor used. The change-over time is accounted for in every state of operation of the actuator.

Presetting the movement time extension

- Enter the determined travelling time extension (by rounding up the determined extension value) into the parameter "Travelling time extension for upward travel" on parameter page "Ax – General" (x = number of output).

Presetting the switchover time for movement direction changes

- Set the parameter "Change-over time for travel direction changes" on parameter page "Ax - Time Settings" (x = number of output) to the required change-over interval.

i In the as-delivered state of the actuator, the switchover time is generally preset to 1 s.

Position calculation of the blind height

The actuator has a comfortable and accurate positioning function. The actuator calculates the current position of the connected shutter or awning or whenever these elements are adjusted either by manual or bus control. The calculated position value is a measure of the height of the curtain (figure 8).

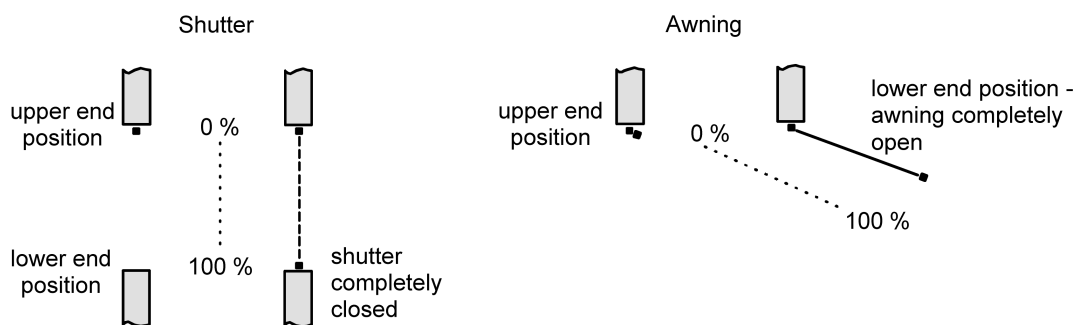

Figure 8: Positions defined as a function of the type of movement

The actuator derives the positions from the configured travelling time since conventional drives do not provide feedback about their positions. Thus, the travelling time separately parameterized for each output is the reference for all position approaches and of basic importance for the accuracy of the position calculations. For this reason, the travelling times should be determined with great accuracy in order to achieve the best possible positioning results.

For positioning purposes, the actuator calculates the movement time required as a function of the current position.

Example 1...

The roller shutter connected to the certain output has an overall travelling time of 20 s. The roller shutter is in its upper end position (0 %). It is to be positioned at 25 %. The actuator calculates the movement time required for approaching the desired position:
 $20 \text{ s} \times 0.25_{(25 \%)} = 5 \text{ s}$. The output will then lower the roller shutter for 5 s and thus position the blind at height of 25 %.

Example 2...

The roller shutter connected to the certain output has an overall travelling time of 20 s. The shutter is in the 25 % position. It is to be positioned at 75 %. The difference between the positions is 50 %. The actuator calculates the travelling time required for bridging the difference between the positions:
 $20 \text{ s} \times 0.5_{(50 \%)} = 10 \text{ s}$. The output will then lower the roller shutter for 10 s and thus position the blind at height of 75 %.

With all the upward movements, the configured movement time extension is automatically added to the calculated movement time.

Example 3...

The shutter connected to the certain output has an overall travelling time of 20 s. The shutter is in the 75 % position It is to be positioned at 25 %. The difference between the positions is 50 %. The actuator calculates the unextended movement time required for bridging the difference between the positions:

$20 \text{ s} \times 0.5_{(50\%)} = 10 \text{ s}$. Taking the movement time extension into account (e.g. 10 %), the actual raising time is: $10 \text{ s} \times ((100\% + 10\%_{(\text{extension})}) : 100\%) = 10 \text{ s} \times 1.1 = 11 \text{ s}$. The output will then raise the roller shutter for 11 s and thus position it at a blind height of 25 %.

When the lower or upper end positions (0 % or 100 %) are approached, the movement time is always 20 % longer than the overall movement time.

Example 4...

The shutter connected to the certain output has an overall travelling time of 20 s. The shutter is in the 75 % position It is to be positioned at 100 %. The difference between the positions is 50 %. The actuator calculates the movement time required for bridging the difference between the positions: $20 \text{ s} \times 0.5_{(50\%)} = 10 \text{ s}$. As the movement is a limit position movement, the actuator adds 20 % of the total movement time:

$10 \text{ s} + (20\% : 100\%) \cdot 20 \text{ s} = 14 \text{ s}$. The output will then lower the roller shutter for 14 s and thus positions it safely at a blind height of 100 %.

Example 5:

The shutter connected to the certain output has an overall travelling time of 20 s. The shutter is in the 75 % position It is to be positioned at 0 %. The difference between the positions is 50 %.

The actuator calculates the unextended movement time required for bridging the difference between the positions: $20 \text{ s} \times 0.5_{(50\%)} = 10 \text{ s}$. As the movement is a limit position movement, the actuator also adds 20 % of the total movement time: $10 \text{ s} + (20\% : 100\%) \cdot 20 \text{ s} = 14 \text{ s}$.

Taking the movement time extension into account (e.g. 10 %), the actual raising time is:

$10 \text{ s} \times ((100\% + 10\%_{(\text{extension})}) : 100\%) = 10 \text{ s} \times 1.1 = 15.4 \text{ s}$. The output will then raise the roller shutter for 15.4 s and thus position safely at 0 %.

- i** The actuator executes position approaches only if a new position deviating from the current position is preset.
- i** The actuator saves the blind/shutter positions temporarily. The actuator can only approach the new, predefined blind/shutter positions when the actual positions are known. For this purpose, each output must be given the opportunity to synchronise itself whenever the supply voltage is switched on or after every ETS programming operation (physical address, application program, partial download). Synchronisation is performed with the help of a reference movement (cf. "reference movement").
- i** Position approaches in progress will be aborted in case of bus or mains voltage failure. In case of bus voltage failure, the configured behaviour will be executed. In case of mains failure, the drives will be stopped. Position approaches are also interrupted when the manual control mode is activated.

Reference movement

After ETS programming (physical address, application program, partial download) or after actuator supply voltage failure (bus and mains voltage) all current position data are unknown. Before the actuator can approach new positions after bus and mains voltage return or after programming, the positioning system must at first be calibrated. A position calibration is possible by executing the reference movement.

A reference movement is the time required for a travel movement into the upper end position increased by 20 % and additionally by the configured travel time extension (figure 9). A reference travel is not retriggerable.

Reference movements can be executed by the following commands...

- Uninterrupted long time operation (including also a terminated safety movement) into the upper end position activated via the corresponding communication object,
- an approach of the 0 % position,
- a manually controlled movement into the upper end position.

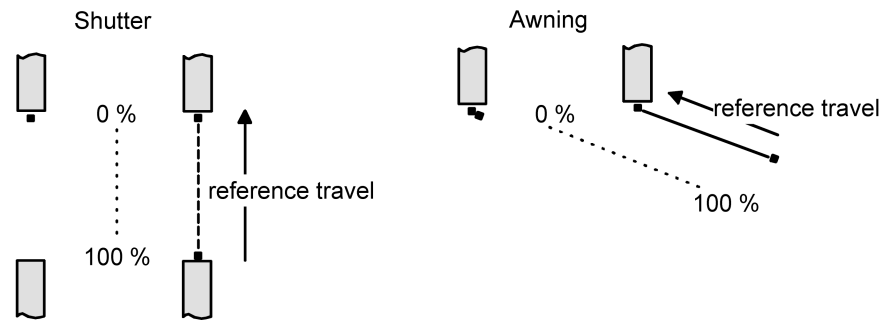

Figure 9: Reference movement

- i** If the reference movement is interrupted for instance by a short-time operation, the position is still unknown as before.
- i** A long-time travel into the lower end position activated via the corresponding communication object also calibrates the reference position.
- i** Using the connected drives frequently for position approaches (for instance several times a day) can result after some time in positioning inaccuracies. These deviations from the setpoint position are mostly due to external physical influences. To achieve accurate positioning in operation it is recommended to perform the reference movement at least once every day. This can be achieved for instance by a central raising command transmitted to the long-time object.

Presetting the position

The following ways of presetting positions can be distinguished...

- Direct positioning via the positioning objects (direct operation),
- Position through the behaviour after bus voltage failure or bus or mains voltage return.

Positioning via the positioning objects:

Each shutter or awning can be positioned for each output directly via the separate Object "Position shutter/awning". The position approached is always the position last received. The actuator does not show a reaction when the set or to be approached position value is received several times in succession.

This type of control, as well as operation by means of short-time and long-time objects, is described as 'direct operation'. Positioning via the objects therefore has the same priority. A position approach effected by the communication objects can be interrupted at any time by a short- or long-time command. The direct operation can be overridden by a function with a higher priority (e.g. manual control, safety function).

The position telegrams must correspond to the 1 byte data format according to KNX datapoint type 5.001 (Scaling). The actuator converts the value received (0...255) linearly into a position (0...100 %) (see the table 1).

Received value (0...255)	Position derived from value (0...100 %)
0	0 % (upper end position)
↓	↓ (all intermediate values rounded off to 1 % increments)
255	100 % (lower end position)

Table 1: Data format of positioning objects with conversion into percentage position values

It is possible that new positioning telegrams are being received while a position approach is in progress. In this case, the actuator immediately reverses the direction of travel, if the new position to be approached lies in the opposite direction.

Position through the behaviour after bus voltage failure or bus or mains voltage return or by a scene recall.

In case of the actuator functions mentioned, the positions to be approached are configured directly in the ETS depending on the operating mode. The position values can be specified between 0 % and 100 % in 1 % increments.

- i** Important notes for all positioning movements: Using the connected drives frequently for position approaches (for instance several times a day) can result after some time in positioning inaccuracies. These deviations from the setpoint position are mostly due to external physical influences. To achieve accurate positioning in operation it is recommended to perform the reference movement at least once every day. This can be achieved for instance by a central raising command transmitted to the long time object.

Position feedback messages

In addition to presetting positions via positioning objects, the actuator can track the current positions values via separate feedback objects and also transmit them to the bus, if the bus voltage is on. Thus, the preset setpoint position can be distinguished from the true actual position of the drives activated.

The following feedback telegrams can be preset for each output...

- Feedback (1-byte) of the shutter or awning position.

The individual position feedback messages can be enabled in the ETS independent of one another and have communication objects of their own.

For each travel movement the actuator calculates the current position and tracks it in the position feedback objects. The positions are tracked and the feedback objects updated even when an output has been activated via short-time or long-time telegrams or by manual control on condition that the bus voltage is on.

The feedback objects are updated after the following events...

- At the end of a drive movement when the drive stops and when the new position is reached,
- With a movement to an end position already at the time the end position is theoretically reached, i.e. before the 20 % extension and the movement time extension have elapsed.

The feedback objects are not updated if the last position reported back has not changed. The actuator cannot calculate a feedback position, if the current position data after switch-on of the supply (bus voltage and mains voltage) or after ETS programming are still unknown. In these cases, the system must first perform a reference movement (cf. "reference movement") so that the position can be calibrated. In case of unknown positions, the actuator automatically performs reference travels, if new positions are preset and if these positions are to be approached. As long as a position is unknown, the value of the feedback objects is "0".

Presetting position feedback for Venetian blind, roller shutter, awning or venting louver positions

The feedback functions can be enabled and programmed independently for each output. The feedback can be used as an active message object or as a passive status object. As an active signalling object, the position feedback information is transmitted to the bus whenever a position value changes. As a passive status object, there is no telegram transmission after a change. In this case, the object value must be read out. The ETS automatically sets the object communication flags required for proper functioning.

In case of an actively transmitting signalling object, the current position can be transmitted to the bus after bus voltage return, if the position value differs from the one last transmitted. When

the position data are known, the feedback telegram can in this case be transmitted with a time delay to reduce the bus load, with the delay being preset globally for all outputs in common (cf. "Delay after bus voltage return").

The feedback functions of an output must be enabled on parameter page

"Ax – Enabled functions" (x = number of output). Only then are the parameters for the feedback functions visible.

- Set the parameter "shutter/awning position feedback" on parameter page "Ax – Feedbacks" to "feedback object is active signalling object".

The feedback object is enabled. The position value is transmitted as soon as it changes. No value will be actively transmitted, if the position is unknown.

- Set the parameter "shutter/awning position feedback" on parameter page "Ax – Feedbacks" to "feedback object is passive status object".

The feedback object is enabled. The position value will be transmitted in response only if the feedback object is read out from by the bus. If the position is unknown, a value of "0" will be reported back after readout.

The feedback must be set as actively transmitting.

- If a time delay after bus voltage return should be necessary, the parameter "Time delay for feedback after bus voltage return" on parameter page "Ax – Feedbacks" must be set to "yes".

The position feedback will be transmitted with a delay after bus voltage return. After the end of the time delay, the position last adjusted statically will be transmitted to the bus. No feedback telegram is transmitted during a running delay, even if a position value changes during this delay.

Feedback 'unknown position'

In addition to position data feedback, the actuator can also report back enlarged 1-bit status information messages and transmit them actively to the bus, if the bus voltage is on.

The following status feedback message can be separately preset for each output...

- Feedback of an invalid position.

After switch-on of the supply voltage (bus and mains voltage failure) or after programming with the ETS, all position data of an output are unknown. In this case – when the bus voltage is on – the actuator can update the feedback object "Invalid position"(object value "1") which will then signal that the object values of the 1-byte position feedback objects are invalid.

An invalid position feedback will be only be reversed (object value "0") after the position data for the shutter or awning have been calibrated by means of a reference movement. As an option, the object value of the status feedback message can be actively transmitted to the bus in case of a value change.

Setting feedback of an invalid position

The feedback of an invalid position can be enabled and programmed independently for each output. The feedback can be used as an active message object or as a passive status object.

As an active signalling object, the status feedback information is transmitted to the bus whenever a position value changes. As a passive status object, there is no telegram transmission after a change. In this case, the object value must be read out. The ETS automatically sets the object communication flags required for proper functioning.

If the object is an actively transmitting signalling object, the feedback telegram can be transmitted after bus voltage return with a time delay to reduce the bus load, with the delay being preset globally for all outputs in common (cf. "Delay after bus voltage return").

The feedback functions of an output must be enabled on parameter page

"Ax – Enabled functions" (x = number of output). Only then are the parameters for the feedback functions visible.

- Set the parameter "Invalid roller shutter/awning position feedback" on the "Ax – Feedbacks" parameter page to "feedback object is active signalling object".
 The feedback object is enabled. A telegram is transmitted as soon as there is a change (e.g. after ETS programming, after switch-on of the supply voltage or after a reference movement).
- Set the parameter "Invalid roller shutter/awning position feedback" on the "Ax – Feedbacks" parameter page to "feedback object is passive status object".
 The feedback object is enabled. A telegram will be transmitted in response only if the feedback object is read out by the bus.

The feedback must be set as actively transmitting.

- If a time delay after bus voltage return should be necessary, the parameter "Time delay for feedback after bus voltage return" on parameter page "Ax – Feedbacks" must be set to "yes".
 The feedback of an invalid position will be transmitted with a delay after bus voltage return. After the end of the time delay, the object value state last adjusted will be transmitted to the bus. No feedback telegram is transmitted during a running delay, even if a position value becomes known during this delay, for example through a reference movement.

i Automatic transmission after bus voltage return only takes place if there has been an internal change to the object state (for example through a reference run during manual operation).

Safety function

The actuator can handle up to five different safety functions: 3 x wind alarm, 1 x rain alarm, 1 x frost alarm. Each safety function has a communication object of its own so that the functions can be activated or deactivated independently of one another. The safety functions are programmed and configured in common for all outputs (see page 24-25).

The different outputs of the actuator can be separately assigned to all or to individual safety functions. Only assigned outputs respond to a change in the state of the safety objects. The reactions at the beginning of an alarm ("1" telegram) can be parameterized for each alarm separately whereas the reaction at the end of an alarm ("0" telegram) can be parameterized for all alarms in common (figure 10).

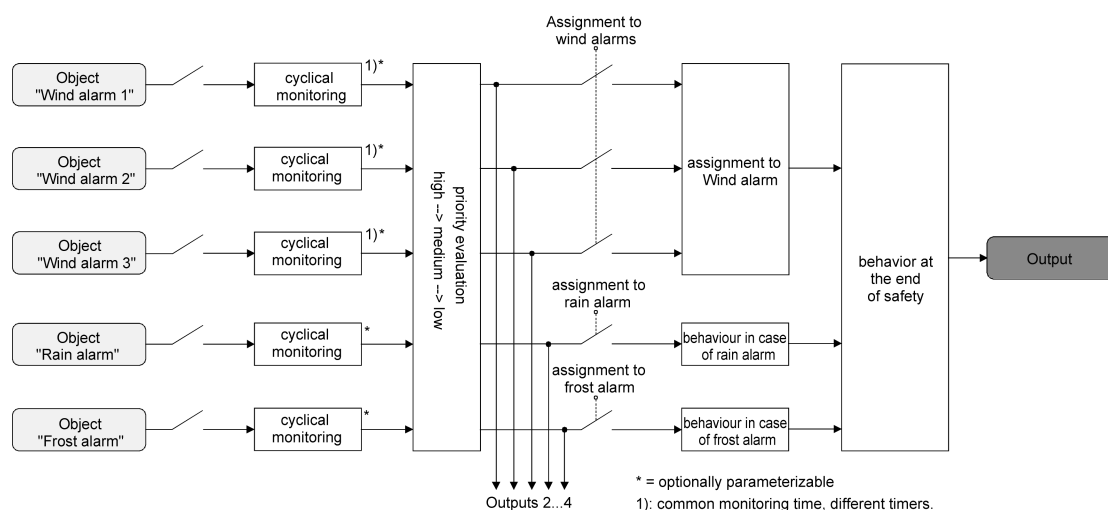

Figure 10: Function diagram of channel-oriented safety functions

An output can be assigned independently to the wind alarms, the rain alarm and the frost alarm. If an output is associated with several alarms, the preset priority decides which of the alarms will

prevail and be executed. In so doing, an alarm with a higher priority overrides the alarms with the lower priorities. When safety alarm with the higher priority has ended, the safety alarm with the lower priority is executed on condition that it is active.

The order of priority of the wind alarms with respect to the frost alarm or to the rain alarm can be configured for several channels on the parameter page "Safety". The three wind alarms have the same priority with respect to one another (logic OR). The last telegram update to the wind alarm objects decides which of the wind alarms will be executed. The wind alarm is completely deactivated only after all three objects are inactive ("0").

An output in the active safety alarm state is locked, i.e. the control of the output concerned via the bus by direct operation (short-time, long-time telegram, positioning) is prevented. Only local manual control on the device has higher priority so that this function can override a safety interlock. At the end of a manual control, the safety reaction is re-executed if an assigned safety alarm is still active.

Assigning safety alarms

The individual safety alarms can be assigned separately for each output. The channels are assigned on parameter page "Ax – Safety" (x = number of output).

The safety functions must be globally enabled on the "Safety" parameter page before the output assignments are configured.

The safety function for an output must be enabled on parameter page "Ax – Enabled functions (x = number of output)". Only then are the channel-related parameters for the safety function visible.

- If an assignment to the wind alarms is necessary, set the parameter "Assignment to wind alarms" to the wind alarm or the wind alarms required.

The output is assigned to the specified wind alarms.

- If an assignment to the rain alarm is necessary, set the parameter "Assignment to rain alarm" to "yes".

The output is assigned to the rain alarm.

- If an assignment to the frost alarm is necessary, set the parameter "Assignment to frost alarm" to "yes".

The output is assigned to the frost alarm.

i If an output is assigned to an alarm which is not globally enabled, the assignment is without effect.

i Important information about the activation or deactivation of a safety alarm, about the presetting of the priority and about cyclical monitoring can be found in chapter "Channel-independent functional description – Safety functions" (see page 24-25).

Presetting the behaviour at the beginning of a safety alarm

The behaviour of an output at the beginning of a safety alarm can be parameterized separately for each alarm (wind alarms in common, rain and frost alarms separately). The alarm behaviour is preset on parameter page "Ax – Safety" (x = number of output). At the beginning of a safety alarm, the actuator locks the outputs concerned, i.e. control via the bus by direct operation is prevented.

The safety functions must be globally enabled on the "Safety" parameter page.

The safety function for an output must be enabled on parameter page "Ax – Enabled functions (x = number of output)". Only then are the channel-related parameters for the safety function visible.

The behaviour in case of a safety alarm can only be adjusted, if the output concerned has been assigned to the corresponding alarm. Since there is no difference between the alarm-dependent configurations, the selection of the parameters is described below only once.

- Set the parameter "Behaviour in case of ..." to "no reaction".

At the beginning of the alarm, the output is locked and the relay of the output shows no reaction. Any movements still in progress at this instant will still be completely finished.

- Set the parameter "Behaviour in case of ..." to "raising".
The actuator raises the curtain at the beginning of the alarm and locks the output thereafter.
 - Set the parameter "Behaviour in case of ..." to "lowering".
The actuator lowers the curtain at the beginning of the alarm and locks the output thereafter.
 - Set the parameter "Behaviour in case of ..." to "stop".
At the beginning of the alarm, the actuator switches the relays of the output to "stop" and locks the output. A drive movement, if any, will be interrupted.
- i** The safety movement time required by an output to move the drive into the end positions is determined by the "Movement time" parameter on parameter page "Ax - Times". Like the long-time operation, a safety movement is derived from the movement time. Downward travel: travel time + 20 %; Upward travel: travel time + 20 % + parameterized or taught-in travel time extension. Safety movements are not retriggerable.

Presetting the behaviour at the end of all safety alarms

The actuator ends the safety interlock of an output only after all safety alarms assigned to the output have become inactive. Thereafter, the output concerned shows the parameterized "Behaviour at the end of safety". The behaviour is configured on parameter page "Ax — Safety" (x = number of output) in common for all alarms.

The safety functions must be globally enabled on the "Safety" parameter page.

The safety function for an output must be enabled on parameter page "Ax – Enabled functions (x = number of output). Only then are the channel-related parameters for the safety function visible.

- Set the parameter "Behaviour at the end of safety" to "no reaction".
At the end of all safety alarms, the output is released and the relay of the output shows no reaction. Any movements still in progress at this instant will still be finished.
 - Set the parameter "Behaviour at the end of safety" to "raising".
The actuator releases the output at the end of all safety alarms and raises the curtain.
 - Set the parameter "Behaviour at the end of safety" to "lowering".
The actuator releases the output at the end of all safety alarms and lowers the curtain.
 - Set the parameter "Behaviour at the end of safety" to "stop".
At the end of all safety alarms, the output is released and the actuator switches the relays of the output to "stop". A drive movement, if any, will be interrupted.
 - Set the parameter "Behaviour at the end of safety" to "tracking the position".
At the end of all safety alarms, the output will be set to the state last adjusted statically before the safety function or to the state tracked and internally stored during the safety function. The position objects and the long time object are tracked.
- i** Parameter setting "Position tracking": The actuator can track absolute positions after safety release (position telegram) only if the position data are known and if the positions have been predefined. In all other cases, no reaction takes place on release of safety. Position data can be tracked, if the output was in a defined position before the safety function or if a new position telegram was received via the position objects during the safety interlock. In the latter case, a reference movement will be executed when the safety function is enabled, if the position before or during the safety interlock was unknown. Long time movements (movements without position preset) will, however, always be tracked.
- i** The preset "Behaviour at the end of safety" will only be executed, if the output passes over to direct operation at the end of all safety alarms.

4.2.4.3 Delivery state

In the as-delivered state, the actuator is passive, i.e. no telegrams are transmitted to the bus. The outputs can, however, be operated by manual control on the device, if the mains voltage is on. In the manual control mode, no feedback telegrams are sent to the bus. Other functions of the actuator are deactivated.

The device can be programmed and put into operation via the ETS. The physical address is preset to 15.15.255.

Moreover the device has been configured at the factory with the following characteristics...

- Movement time (continuous run): 20 minutes
- Movement time extension: 2 %
- Break during movement direction changeover: 1 s
- Behaviour in case of bus voltage failure: no reaction
- Behaviour on bus or mains voltage return: Stop

4.2.5 Parameters

Description	Values	Comment
<input type="checkbox"/> General		
Delay after bus voltage return Minutes (0...59)	0...59	<p>To reduce telegram traffic on the bus line after bus voltage activation (bus reset), after connection of the device to the bus line or after programming with the ETS, it is possible to delay all active feedback telegrams of the actuator. The parameter specifies in this case a delay valid for all devices. Only after the time configured here has elapsed are feedback telegrams for initialisation transmitted to the bus.</p> <p>Setting the delay time minutes.</p>
Seconds (0...59)	0...17...59	<p>Setting the delay time seconds.</p>
<input type="checkbox"/> Safety		
Safety functions	disabled Enabled	<p>When the safety functions of the actuator, which can number up to 5, are used and should thus be configurable, the channel-independent enabling of the function must occur here (setting: "enabled"). If the safety functions (setting: "disabled") are deactivated, the possible configured assignment of individual outputs for the monitoring of safety is not operational.</p>
Wind alarm 1	disabled Enabled	<p>This parameter can be used to enable the first wind alarm and thus to enable the communication object (setting: "enabled"). If the first wind alarm is deactivated (setting: "disabled"), any programmed assignment of individual outputs to wind alarm 1 is not operational.</p>
Wind alarm 2	disabled Enabled	<p>This parameter can be used to enable the second wind alarm and thus to enable the communication object (setting: "enabled"). If the second wind alarm is deactivated (setting: "disabled"), any programmed assignment of individual outputs to wind alarm 2 is not operational.</p>
Wind alarm 3	disabled Enabled	<p>This parameter can be used to enable the third wind alarm and thus to enable the communication object (setting: "enabled"). If the third wind</p>

		alarm is deactivated (setting: "disabled"), any programmed assignment of individual outputs to wind alarm 3 is not operational.
Rain alarm	disabled Enabled	This parameter can be used to enable the rain alarm and thus to enable the communication object (setting: "enabled"). If the rain alarm is deactivated (setting: "disabled"), any programmed assignment of individual outputs to the rain alarm is not operational.
Frost alarm	disabled Enabled	This parameter can be used to enable the frost alarm and thus to enable the communication object (setting: "enabled"). If the frost alarm is deactivated (setting: "disabled"), any programmed assignment of individual outputs to the frost alarm is not operational.
Priority of safety alarms	wind -> rain -> frost wind -> frost -> rain rain -> wind -> frost rain -> frost -> wind frost -> rain -> wind frost -> wind -> rain	This parameter defines the priority ranking of the individual safety alarms. Interpretation: high -> medium -> low. <ul style="list-style-type: none"> i The three wind alarms have the same priority with respect to one another. i The safety alarm enabling parameters and the priority parameter is only visible when the safety functions are enabled.
<input type="checkbox"/> Safety times		
Use wind alarm monitoring function ? (only if wind alarms are enabled!)	Yes No	If the wind alarms enabled under "Safety" are to be monitored cyclically for incoming telegrams to the safety objects, the monitoring function must be enabled here (setting: "yes"). Otherwise (setting: "No") there is no cyclical monitoring of the objects. <ul style="list-style-type: none"> i As soon as the monitoring function is activated here, telegrams must be transmitted cyclically to all enabled wind alarm objects. i The monitoring function may only be activated, if at least one wind alarm has been activated under "Safety".
	0...23	The wind alarm monitoring time is configured here.

<p>Time for monitoring wind alarm Hours (0...23)</p>			<p>Sets the monitoring time hours.</p>
<p>Minutes (1...59)</p>	<p>1...25...59</p>		<p>Sets the monitoring time minutes.</p> <ul style="list-style-type: none"> i The cycle time of the transmitter should be less than half the parameterized monitoring time of the actuator. i The times can only be set, if wind alarm monitoring is activated.
<p>Use rain alarm monitoring function ?</p>	<p>Yes No</p>		<p>If the rain alarm enabled under "Safety" is to be monitored cyclically for incoming telegrams to the safety object, the monitoring function must be enabled here (setting: "yes"). Otherwise (setting: "No") there is no cyclical monitoring of the object.</p> <ul style="list-style-type: none"> i As soon as the monitoring function is activated, telegrams must be transmitted cyclically to the enabled rain alarm object. i The parameter is only visible, if the rain alarm has been enabled under "Safety".
<p>Time for monitoring rain alarm Hours (0...23)</p>	<p>0...23</p>		<p>The rain alarm monitoring time is configured here.</p>
<p>Minutes (1...59)</p>	<p>1...2...59</p>		<p>Sets the monitoring time hours.</p> <p>Sets the monitoring time minutes.</p> <ul style="list-style-type: none"> i The cycle time of the transmitter should be less than half the parameterized monitoring time of the actuator. i The times can only be set if rain alarm monitoring is activated.
<p>Use frost alarm monitoring function ?</p>	<p>Yes No</p>		<p>If the frost alarm enabled under "Safety" is to be monitored cyclically for incoming telegrams to the safety object, the monitoring function must be enabled here (setting: "yes"). Otherwise (setting: "No") there is no cyclical monitoring of the object.</p> <ul style="list-style-type: none"> i As soon as the monitoring function is activated, telegrams must be transmitted cyclically to the enabled frost alarm object. i The parameter is only visible, if the frost alarm has been enabled under "Safety".

Time for monitoring frost alarm Hours (0...23)	0...23	The frost alarm monitoring time is configured here. Sets the monitoring time hours.
Minutes (1...59)	1... 2 ...59	Sets the monitoring time minutes. i The cycle time of the transmitter should be less than half the parameterized monitoring time of the actuator. i The times can only be set, if frost alarm monitoring is activated.
<input type="checkbox"/> Manual operation		
Manual control in case of bus voltage failure	Disabled Enabled	This parameter can be used for programming whether manual control is to be possible (enabled) or deactivated in case of bus voltage failure.
Manual control during bus operation	Disabled Enabled	This parameter can be used for programming whether manual control is to be possible (enabled) or deactivated during bus operation (bus voltage on).
Disabling function ?	Yes No	Manual control can be disabled via the bus, even if it is already active. For this purpose, the disabling object can be enabled here.
Polarity of disable object	0 = enabled; 1 = disabled 0 = disabled; 1 = enabled	This parameter sets the polarity of the disabling object. i Only visible if the disabling function for manual control is enabled.
Transmit status ?	Yes No	The current state of manual control can be transmitted to the bus via a separate status object, if bus voltage is available (setting: "Yes").
Status object function and polarity	0 = inactive; 1 = man.contr.active 0 = inactive; 1 = perman. man. control active	This parameter defines the information contained in the status object. The object is always "0", when the manual control mode is deactivated. The object is "1" when the manual control mode is active (temporary or permanent). The object is "1" only when the permanent manual control is active.

Behaviour at the end of permanent manual control during bus operation

No change

output tracking

Disable bus control of individual outputs during bus operation

Yes
No

☐ Ax - General

Behaviour after ETS programming

Raising

Lowering

stop

- ☐ **i** This parameter is visible only if the manual control status transmission is enabled.
- ☐ **i** After bus voltage return, the status will only be transmitted actively to the bus ("0") if a manual control was ended by the bus return.

The behaviour of the actuator at the end of permanent manual control depends on this parameter.

All telegrams received during an active permanent manual control mode for direct operation (long-time/short-time, positioning) will be rejected. After the end of the permanent manual control mode, the current state of all outputs remains unchanged. If, however, a function with a higher priority is being activated during manual control (safety), the actuator activates the higher-ranking function for the corresponding outputs.

During an active permanent manual control all incoming telegrams (short-time telegrams excepted) are internally tracked. At the end of manual control, the outputs are adjusted accordingly.

Individual outputs can be disabled locally during permanent manual control, so that the disabled outputs can no longer be controlled via the bus. Disabling via manual control is only permitted if this parameter is set to "Yes".

The actuator permits setting the preferred relay contact position after ETS programming separately for each output.

After programming with the ETS, the actuator raises the blind.

After programming with the ETS, the actuator lowers the blind.

After programming with the ETS, the actuator switches the relays of the output to the "stop" position. A drive movement, if any, will be interrupted.

Behaviour in case of bus voltage failure	stop	<p>i The configured behaviour will be executed after every application or parameter download by the ETS. A simple download of the physical address alone or partial programming of only the group addresses has the effect that this parameter is disregarded and that the configured "Behaviour after bus/mains voltage-return" will be executed instead.</p>
	Raising	<p>The actuator permits setting the preferred relay contact position in case of bus voltage failure separately for each output.</p>
	Lowering	<p>In case of bus voltage failure, the actuator switches the relays of the output to the "stop" position. A drive movement, if any, will be interrupted.</p>
	Approaching a position	<p>After bus voltage failure, the actuator raises the blind.</p>
	No reaction	<p>After bus voltage failure, the actuator lowers the blind.</p>
		<p>In case of bus voltage failure, the connected drive can approach a position specified by further parameters.</p>
		<p>In the event of bus voltage failure, the relay of the output shows no reaction. Any drive movements still in progress at the time of failure will be completely finished.</p>
		<p>i The configured behaviour will only be executed, if no manual control is activated.</p>
Position of roller shutter/ awning in case of bus voltage failure (0...100%)	0...100	<p>This parameter specifies the roller shutter or awning position to be approached in case of bus voltage failure.</p>
		<p>i This parameter is only visible, if "Behaviour in case of bus voltage failure" is set to "approach position".</p>
Behaviour after bus or mains voltage return	stop	<p>The actuator permits setting the preferred relay contact position after mains voltage return separately for each output. This means that the configured behaviour is executed when either the bus or the mains voltage is switched on again.</p>
		<p>In case of bus or mains voltage return, the actuator switches the relays of the output to the "stop" position. A drive movement, if any, will be interrupted.</p>

	Raising	After bus or mains voltage return, the actuator raises the curtain.
	Lowering	After bus or mains voltage return, the actuator lowers the curtain.
	Position during bus/sup. vltg. failure	After bus or mains voltage return, the state last existing and internally stored <u>before</u> bus or mains voltage failure will be tracked.
	Approaching a position	On bus or mains voltage return, the connected drive can travel to a position specified by other parameters.
	No reaction	In the event of bus or mains voltage return, the relay of the output shows no reaction. Any drive movements still in progress at the time of failure will be completely finished. The reactions active at the time of mains failure are re-executed on return of the mains supply. Interrupted short or long time travel movements are restarted at full length and position approaches are continued from the point of interruption.
Roller shutter/awning position on bus/mains voltage return (0...100%)	0...100	This parameter specifies the roller shutter or awning position to be approached in case of bus or mains voltage return. i This parameter is only visible, if "Behaviour in case of bus or mains-voltage return" is set to "approach position".
Travelling time extension for upward travel	none 0.5 % 1 % 1.5 % 2 % 3 % 4 % 5 % 6 % 7 % 8 % 9 % 10 % 12.5 % 15 % 30 %	The actuator extends the time of all upward movements by means of the time extension configured here. The time extension expressed in percent is the difference between the measured travel time needed to reach the lower end position and the time needed to reach the upper end position.
<input type="checkbox"/> Ax - Times		
Short time operation		This parameter can be used to configure the reaction to a received short time telegram.
	No (only stop)	The drive will only be stopped if it is executing a movement at the time of

	Yes	telegram reception. There is no reaction if no movement is in progress.
		Short-time operation is started on reception of a short-time telegram when the drive is stationary. If the drive is in motion at the time of telegram reception, it will be stopped.
Time for short time operation Seconds (0...59)	0...59	This parameter defines the duration of short-time operation.
Milliseconds (0...99 x 10)	0...50...99	Sets the monitoring time seconds. Sets the monitoring time milliseconds.
		i The duration of short time operation should in no case exceed half the slat adjusting time.
		i This parameter is only visible, if the parameter "Short-time operation" is set to "yes".
Roller shutter/awning travelling time Minutes (0...19)	0...1...19	This parameter defines the travelling time of the roller shutter or awning. The time needed for a complete travel from the upper into the lower end position must be determined.
Seconds (0...59)	0...59	Sets the minutes of the roller shutter/awning moving time. Sets the seconds of the roller shutter/awning moving time.
		i The travelling time must be determined precisely.
Switchover time for travel direction change	0.5 sec 1 sec 2 sec 5 sec	Specifies the break in a travel direction change (switchover time).
<input type="checkbox"/> Ax - Enabled functions		
Feedback functions	disabled Enabled	This parameter can be used to disable or to enable the feedback functions. When the function is enabled, the required parameters will be displayed under "Ax –Feedbacks".
Safety functions	disabled Enabled	This parameter can be used disable or to enable the safety functions. When the function is enabled, the required parameters will be displayed under "Ax –Safety".

□- Ax - Feedback telegrams

Roller shutter/awning position feedback

The current roller shutter or awning position of the output can be reported separately back to the bus.

no feedback

No feedback object available for the output. Feedback deactivated.

feedback object is active signalling object

Feedback and the object are activated. The object transmits actively.

Feedback object is passive status object

Feedback and the object are activated. The object is passive (telegram transmission only as a response to 'Read' request).

i The communication flags of the object are automatically set by the ETS according to the setting.

Time delay for feedback telegram after bus voltage return ?

Yes (delay time under "General"!) **No**

The feedback telegram can be transmitted to the bus with a delay after bus voltage return or after programming with the ETS. Setting "Yes" activates the delay time of the feedback in case of bus voltage return. The delay time is configured under "General".

i This parameter is only visible in case of an actively transmitting feedback object.

Invalid roller shutter/awning position feedback

The actuator can report to the bus that the current roller shutter/awning position is unknown (e.g. after an initialisation, when no reference travel has been executed as yet).

no feedback

No feedback object available for the output. Feedback deactivated.

Feedback object is active signalling object

Feedback and the object are activated. The object transmits actively.

Feedback object is passive status object

Feedback and the object are activated. The object is passive (telegram transmission only as a response to 'Read' request).

i The communication flags of the object are automatically set by the ETS according to the setting.

Time delay for feedback telegram after bus voltage return ?

Yes (delay time under "General"!) **No**

The feedback telegram can be transmitted to the bus with a delay after bus voltage return or after programming with the ETS. Setting "Yes" activates the delay time of the feedback in case of bus voltage return. The delay time is configured under "General".

i This parameter is only visible in case of an actively transmitting feedback object.

Ax - Safety

Assignment to wind alarms

No

This parameter defines whether the output responds to a wind alarm and to which of the alarms.

Wind alarm 1

Wind alarm 2

Wind alarm 3

Wind alarm 1 + 2

Wind alarm 1 + 3

Wind alarm 2 + 3

Wind alarm 1 + 2 + 3

Behaviour in case of wind alarm

This parameter defines the behaviour of the output at the beginning of a wind alarm.

No reaction

At the beginning of the wind alarm or wind alarms, the output is interlocked and the relay of the output shows no reaction. Any movements in progress at this instant will still be completely finished.

Raising

The actuator raises the curtain at the beginning of the wind alarm or wind alarms and locks the output thereafter.

Lowering

The actuator lowers the curtain at the beginning of the wind alarm or wind alarms and locks the output thereafter.

stop

At the beginning of the wind alarm or wind alarms, the actuator switches the relays of the output to "stop" and locks the output. A drive movement, if any, will be interrupted.

i The behaviour preset in this parameter will be executed when one of the assigned wind alarms is activated.

i This parameter is only visible if the output has been assigned to at least one wind alarm.

Assignment to rain alarm

Yes

This parameter defines whether the output responds to the rain alarm.

No

Behaviour in case of rain alarm

This parameter defines the behaviour of the output at the beginning of the rain alarm.

No reaction

At the beginning of the rain alarm, the output is locked and the relay of the output shows no reaction. Any movements in progress at this instant will still be completely finished.

Raising

The actuator raises the curtain at the beginning of the rain alarm and locks the output thereafter.

Lowering

The actuator lowers the curtain at the beginning of the rain alarm and locks the output thereafter.

stop

At the beginning of the rain alarm, the actuator switches the relays of the output to "stop" and locks the output. A drive movement, if any, will be interrupted.

i This parameter is only visible, if the output has been assigned to the rain alarm.

Assignment to frost alarm

Yes

This parameter defines whether the output responds to the frost alarm.

No

Behaviour in case of frost alarm

This parameter defines the behaviour of the output at the beginning of the frost alarm.

No reaction

At the beginning of the frost alarm, the output is interlocked and the relay of the output shows no reaction. Any movements in progress at this instant will still be completely finished.

Raising

The actuator raises the curtain at the beginning of the frost alarm and locks the output thereafter.

Lowering

The actuator lowers the curtain at the beginning of the frost alarm and locks the output thereafter.

stop

At the beginning of the frost alarm, the actuator switches the relays of the output to "stop" and locks the output. A drive movement, if any, will be interrupted.

i This parameter is only visible, if the output has been assigned to the frost alarm.

Behaviour at the end of safety (Wind, rain, frost)

This parameter defines the behaviour of the output at the end of all safety functions.

No reaction	At the end of the safety functions, the output is unlocked and the relay of the output shows no reaction. Any movements still in progress at this instant will still be finished.
Raising	The actuator unlocks the output at the end of all safety alarms and raises the curtain.
Lowering	The actuator unlocks the output at the end of all safety alarms and lowers the curtain.
stop	At the end of the safety functions, the output is unlocked and the actuator switches the relays of the output into the "stop" position. A drive movement, if any, will be interrupted.
Tracking the position	At the end of safety, the output will be set to the state last adjusted before the safety function or to the state tracked and internally stored during the safety function. The position objects and the long time object are tracked.

5 Appendix

5.1 Index

A	
as-delivered state.....	40
B	
bus or mains voltage return.....	27
bus voltage failure.....	27
C	
commissioning.....	17
Commissioning.....	9
Controls and indicators.....	11
D	
Determining.....	30
E	
ETS	17
ETS search paths.....	15
L	
long-time operation.....	29
M	
Manual operation.....	21
movement time extension.....	31
P	
Parameter General.....	41
Position calculation.....	32
Position feedback messages.....	35
Presetting the position.....	34
product database.....	17
programming with the ETS.....	27
R	
Reference movement.....	33
S	
Safe-state mode.....	17
Safety function.....	37
Safety functions:.....	24
short-time.....	29
switchover time.....	31

ALBRECHT JUNG GMBH & CO. KG
Volmestraße 1
D-58579 Schalksmühle

Telefon: +49.23 55.8 06-0
Telefax: +49.23 55.8 06-1 89
E-mail: mail.info@jung.de
Internet: www.jung.de
www.jung-katalog.de