



Product documentation

Switch actuator, 4-gang / blinds actuator, 2-gang
Art. No. 2304.16 REG HE

Switch actuator, 8-gang / blinds actuator, 4-gang
Art. No. 2308.16 REG HE

Switch actuator, 16-gang / blinds actuator, 8-gang
Art. No. 2316.16 REG HE

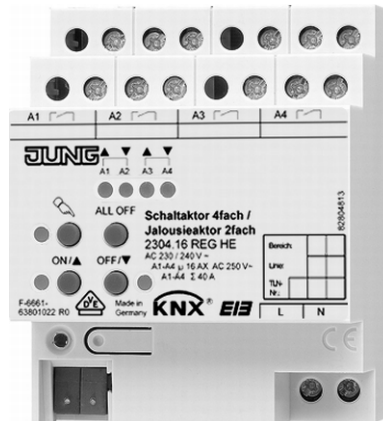

ALBRECHT JUNG GMBH & CO. KG
Volmestraße 1
58579 Schalksmühle

Telefon: +49.23 55.8 06-0
Telefax: +49.23 55.8 06-2 04
kundencenter@jung.de
www.jung.de

Service Center
Kupferstr. 17-19
44532 Lünen
Germany

Contents

1	Product definition	3
1.1	Product catalogue	3
1.2	Function	3
2	Installation, electrical connection and operation	4
2.1	Safety instructions	4
2.2	Device components	5
2.3	Fitting and electrical connection	7
2.4	Commissioning	11
2.5	Operation	14
3	Technical data	19
4	Software description	21
4.1	Software specification	21
4.2	Software "Switching, shutter/blind 20CA11 / 2078x2 / 2080x2"	23
4.2.1	Scope of functions	23
4.2.2	Notes on software	25
4.2.3	Object table	26
4.2.4	Functional description	33
4.2.4.1	Description of channel-independent functions	33
4.2.4.2	Channel-oriented functional description	44
4.2.4.2.1	Functional description of the switching outputs	44
4.2.4.2.2	Functional description of the venetian blind outputs	62
4.2.4.3	Delivery state	104
4.2.5	Parameters	105
5	Appendix	148
5.1	Index	148

1 Product definition

1.1 Product catalogue

Product name: Switching act. 4gang / shutter act. 2gang 16A SE / Switching act. 8gang / shutter act. 4gang 16A SE / Switching act. 16gang / shutter act. 8gang 16A SE

Use: Actuator

Design: Rail-mounted device

Art. No. 2304.16 REG HE / 2308.16 REG HE / 2316.16 REG HE

1.2 Function

The switch/blind actuator receives telegrams from sensors or other controls via the KNX and switches electrical loads. The relay outputs of the actuator can be set in the ETS software configuration either to blinds operation or alternatively to switching operation; mixed operation of these two modes of operation is also possible on the device. In blinds operation the relay contacts of the switching / blind actuator can be used to control electrically driven blinds, shutters, awnings, venting louvers or similar curtains for 230 V AC mains voltage. Alternatively, the actuator can switch electrical loads, such as lighting systems or low voltages in switching operation. Each relay output is equipped with mains-operated monostable switching relays so that the preferred contact positions are maintained also during bus voltage failure.

The controls (4 pushbuttons) on the front panel of the device permit switching the relays on and off by hand in parallel with the KNX even without bus voltage or in a non-programmed state. This feature permits fast checking of connected loads for proper functioning.

The functionalities that can be preset with the ETS independently for each output channel in blinds operation include, for instance, separately configurable travelling times, expanded feedback functions, assignments to up to 5 different safety functions, an extensive sun protection function, and incorporation into scenes or forced position applications (scenes or forced-position applications for the switch/blind actuator 8/16-gang only available with ETS3.0d and higher). Centralized control of all blind outputs is also possible.

In switching operation the functionalities for each output include, for example, extensive time functions, logic operations, scenes, disabling functions or alternatively forced positions and expanded feedback telegrams (scenes or forced-position applications for the switch/blind actuator 8/16-gang only available with ETS3.0d and higher). The central switching of all switching outputs is possible, too.

Moreover, the preferred states of the relays in case of bus voltage failure or bus / mains voltage return and after ETS programming can be preset separately.

For project design and commissioning of the devices, we recommend using the ETS3.0 from Version "d" patch "A" or the ETS4.0. Advantages with regard to downloading (significantly shorter loading times) and parameter programming can be expected only if this ETS versions or later versions are used.

The switching / blind actuator has its own mains voltage connection that is independent of the connected drives or loads. For actuation of the outputs, the 230 V mains supply must always be switched on. The device electronics are supplied from the bus voltage or from the mains voltage. The device is designed for mounting on DIN rails in closed compact boxes or in power distributors in fixed installations in dry rooms.

2 Installation, electrical connection and operation

2.1 Safety instructions

Electrical equipment may only be installed and fitted by electrically skilled persons. The applicable accident prevention regulations must be observed.

Failure to observe the instructions may cause damage to the device and result in fire and other hazards.

Danger of electric shock. The actuator is not suitable for disconnection from supply voltage.

Danger of electric shock. Do not connect mains voltage and SELV/PELV circuits together to the outputs of the actuator.

Danger of electric shock. Make sure during the installation that there is always sufficient insulation between the mains voltage and the bus. A minimum distance of at least 4 mm must be maintained between bus conductors and mains voltage cores.

For parallel connection of several drives to an output it is indispensable to observe the corresponding instructions of the manufacturers. There is otherwise risk of irreparable damage to the drives.

Danger of electric shock. Before working on the device or exchanging the connected loads, disconnect it from the power supply (switch off the miniature circuit breaker).

Do not connect any three-phase motors. Device can be damaged.

Use only drive motors with mechanical or electronic limit switches. Check the limit switches for correct adjustment. Observe the specifications of the motor manufacturers. Device can be damaged.

2.2 Device components

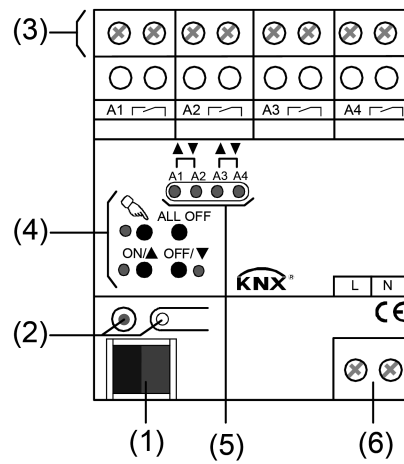

Figure 1: Switching / blind actuator 2/4gang

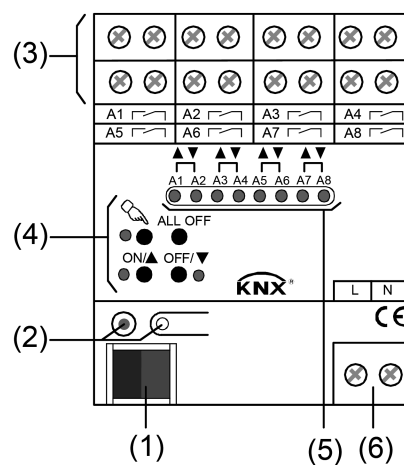

Figure 2: Switching / blind actuator 4/8gang

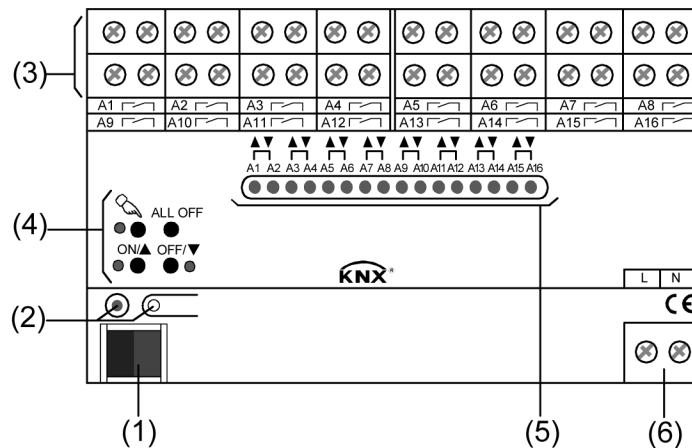

Figure 3: Switching / blind actuator 8/16gang

- (1) KNX bus connection
- (2) Programming button and LED (red). The programming LED flashes slowly when the safe-state mode is active.
- (3) Screw terminal (Ax, —) for connection of the different loads
- (4) Button field for manual control with status LEDs
- (5) Status LED for the outputs with movement direction indication or switching position indication (1 LED per output):
 LED off: output switched off
 LED on: Output switched on (in shutter/blinds operation: movement up "▲" or movement down "▼")
 LED flashing slowly: output in manual control
 LED flashing quickly: output blocked by manual control
- (6) Mains voltage terminal for power supply to the device electronics

2.3 Fitting and electrical connection



DANGER!

Electrical shock when live parts are touched.

Electrical shocks can be fatal.

Before working on the device, disconnect the power supply and cover up live parts in the working environment.



DANGER!

Electrical shock on all SELV/PELV circuits when loads for mains voltage and SELV/PELV are both connected to an actuator.

Electrical shocks can be fatal. Danger of destruction of all devices connected to the SELV/PELV.

Do not connect any loads for SELV/PELV/FELV!



CAUTION!

Overloading the device leads to excessive heating.

Damage to the device and the connected cables may result.

Do not exceed the maximum current carrying capacity (refer to "Technical data").

Load neighbouring outputs up to a max. of 20 A only.





CAUTION!

Danger of destruction if several motors are connected in parallel to one output.

Limit switch contacts can weld together and motors, blinds/shutters and the venetian blind actuator can be destroyed.

Observe the manufacturer's instructions. Use cutoff relay if necessary!

Fitting the device

- Mount device on DIN rail according to DIN EN 60715. The screw terminals for connection of the motors must be at the top.
-  A KNX data rail is not required.
-  Observe the temperature range (-5 °C ...+45 °C) and ensure sufficient cooling, if necessary.

Connecting the power supply for the device electronics

- Connect the bus (standard bus terminal) and the mains voltage supply as shown in (figure 4) (connection example).

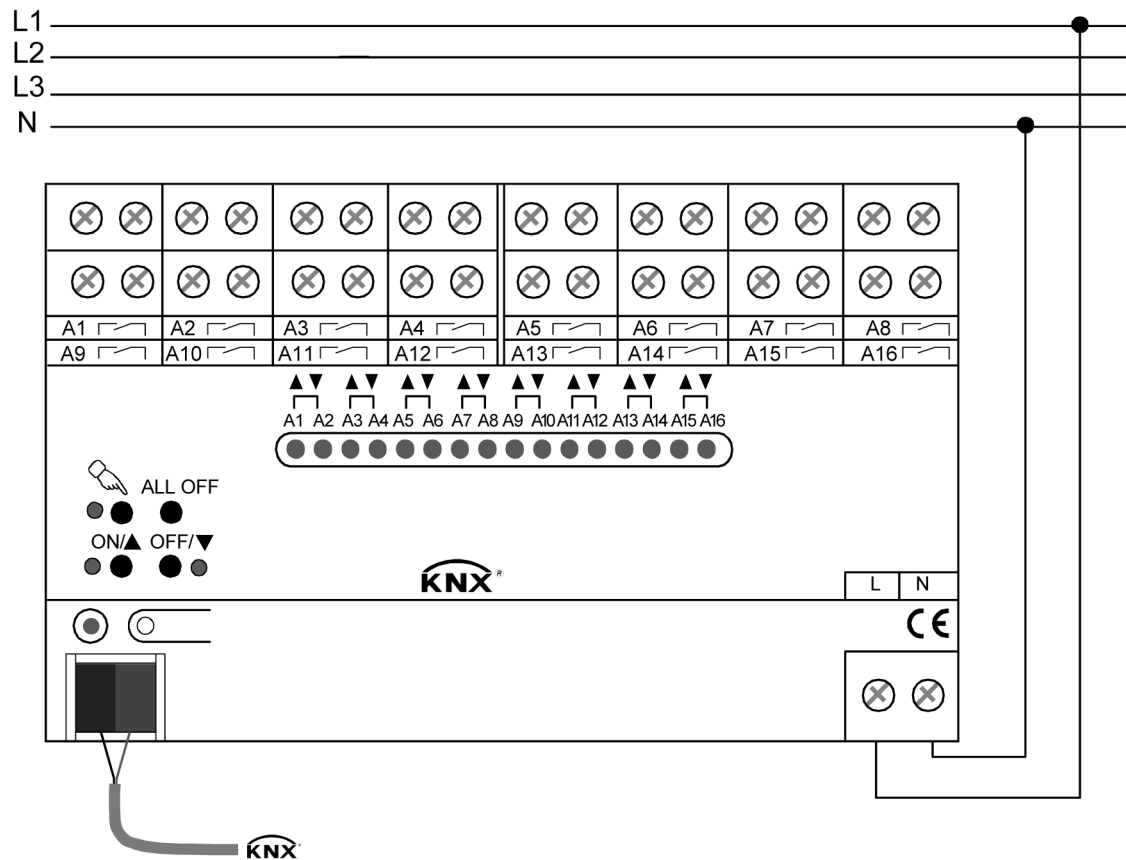

Figure 4: Electrical connection of mains voltage

- i** The device can be used with different phase conductors (L1, L2, L3).
- i** For actuation of the outputs – even in manual control mode – the mains supply must be on. The power supply for the device electronics (BCU with application program) is drawn from the bus voltage or from the mains voltage.
- i** The connection of drive motors in blinds operation or of loads in switching operation is described on the following pages.

Connect device for 230 V drive motors in blinds operation

In blinds operation, each pair of adjacent relay outputs forms a blind output. In each case the left-hand relay output (A1, A3, ...) is intended for the UP direction (▲), and the right-hand load output (A2, A4, ...) for the DOWN direction (▼).

The switching / blind actuator must be set in the ETS to blinds operation for the corresponding output channel (1 x blind output) (this setting also corresponds to the state as supplied).

- Connect drive motors as shown in (figure 5) (connection example).

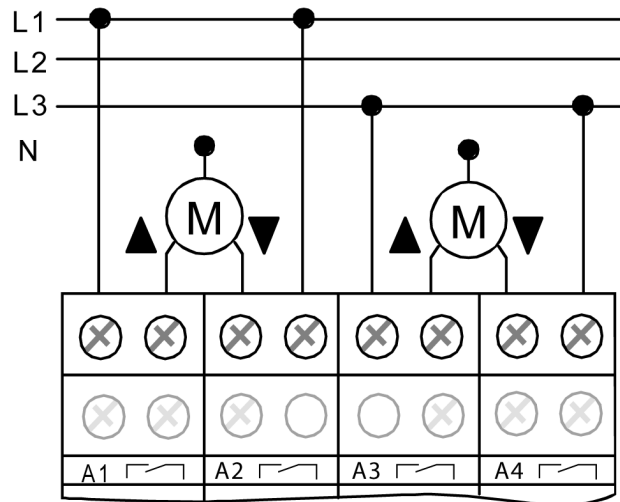

Figure 5: Electrical connection for 230 V drives in blinds operation

- i** Observe the admissible load ratings (cf. 'Technical data').
- i** The device can be used with different phase conductors (L1, L2, L3).
- i** Venting louvres must be connected in such a way that they open in travel direction "UP - ▲" and close in travel direction "DOWN - ▼".

Connecting the device for loads in switching operation

In switching operation the outputs can be activated independently of each other. The switching / blind actuator must be set in the ETS to switching operation for the corresponding output channel (2 x switching output).

- i** Observe the admissible load ratings (see "Technical data").
- i** Various phase conductors (L1, L2, L3) can be connected to the outputs.
- i** Do not connect any three-phase motors.

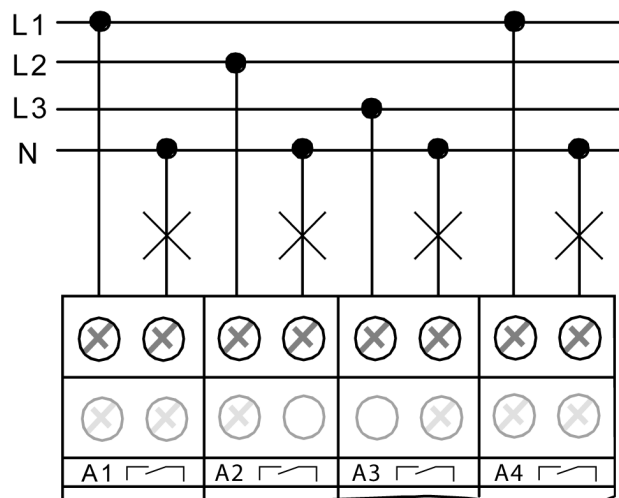

Figure 6: Electrical connection for loads in switching operation

Total current capacity of neighbouring outputs

The total current capacity of neighbouring outputs is a maximum of 20 A (figure 7).

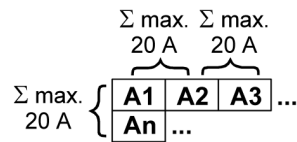

Figure 7: Total current capacity of neighbouring outputs

Installing / removing the protective cap

To protect the bus lines against hazardous voltages, especially in the area of the connecting terminals, a protective cap can be installed.

The cap is installed with the bus terminal in place and the connected bus line led out at the rear.

- To install the cap: slide the cap backwards until you feel it engage (figure 8).
- To remove the cap: Push the cap sideways slightly and pull off toward the front (figure 8).

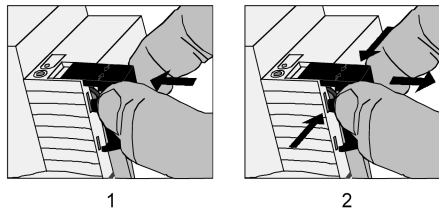

Figure 8: Installing / removing the protective cap.

2.4 Commissioning

After installation of the actuator and connection of the bus line, the mains supply and of all electrical loads, the device can be put into operation. For blinds operation only, special commissioning steps have to be performed prior to programming with the ETS. The following procedure is generally recommended...



DANGER!

Electrical shock on contact with live parts in the installation environment.

Electrical shocks can be fatal.

Before working on the device, disconnect the power supply and cover up live parts in the working environment.

Measuring the travelling times (only in blinds operation)

For the purpose of positioning blinds, shutters and awnings or for adjusting the opening angle of venting louvers, the actuator needs accurate information about the maximum travelling time.

Switch on the mains supply.

- If not yet done, move the blind/shutter into the upper end position (open venting louver completely).
The upper limit-stop position is reached (venting louver opened).
- Start the measuring time and move the blind/shutter by manual control into the lower end position (close the venting louver completely).
- Stop the time measurement when the lower limit (when the completely closed) position is reached.
- Enter the measured value in the ETS (cf. "software description").

i It is wise to perform several time measurements and to take the average of these values.

i The travelling time can also be determined after commissioning with the ETS (bus operation).

Measuring the travelling time extension (only in shutter / blinds operation)

When travelling upwards, blinds or shutters have a tendency of moving more slowly due to their own weight or to external physical influences (e.g. temperature, wind, etc.). The same applies to venting louvers where opening may take longer than closing.

For this reason, the switching / blind actuator takes the parameterized travelling time extension into account when moving upwards or when opening the louvers (MOVE operation / positioning). The extension is computed as a percentage of the difference of the travelling times in both directions.

The blind/shutter (venting louver) must be in the lower end position (venting louver closed).

Switch on the mains supply.

- If not yet done, move the blind/shutter into the lower end position (close venting louver completely).
Lower end position reached (venting louver closed).
- Start the measuring time and move the blind/shutter by manual control into the upper end position (open the venting louver completely).
- Stop the time measurement when the upper limit (the completely open) position is reached.
- Express the measured value as a percentage of the determined blind/shutter travelling time and enter the value in the ETS (cf. software description).

i It is wise to perform several time measurements and to take the average of these values.

- i** The travelling time extension can also be determined after commissioning with the ETS (bus operation).

Measuring the slat moving time (only for blinds in blinds operation)

In the case of blinds with slats, the slat moving time is for technical reasons part of the overall travelling time of the blind. The slat moving time is the time required for a movement between the slat positions "closed – 100 %" and "open – 0 %". In order to compute the opening angle of the slats, the actuator needs an information about the slat moving time.

The slats must be completely closed (as in case of downward travel of the blind).

Switch on the mains supply.

- Start the measuring time and open the slats completely by manual control (as in case of upward travel of the blind).
- Take the measuring time when the completely open position is reached.
- Enter the measured value in the ETS (cf. "software description").

- i** It is wise to perform several time measurements and to take the average of these values.
- i** The slat moving time can also be determined after commissioning with the ETS (bus operation).

Commissioning with the ETS

Before programming the application program and the parameters with the ETS, it must be ensured that the output assignment parameter configurations (channel definitions) correspond to the electric loads connected to the actuator.

- Switch on the bus voltage
Check: When the programming button is pressed, the red programming LED must light up.
- Download the physical address and the application data with the ETS.
- i** When the mains supply is on, the outputs of the actuator can be switched manually even if there is no bus voltage or if the actuator is not yet programmed. Due to this feature, the loads or drives connected to the individual outputs can be checked for proper functioning already during building site operation.

Performing a reference travel (optional only in blinds operation)

The switching / blind actuator can approach predefined blind/shutter or louver positions only if the current positions are known. For this purpose, each output must be given the opportunity to synchronise itself whenever the supply voltage is switched on or after every ETS programming operation (physical address, application program, partial download). This synchronisation is performed by means of the reference movement.

Switch on the mains supply.

- If not yet done, move the curtains to the upper end position (open venting louver completely).
- Wait until the output relay has switched off (not only the limit switch of the drive).
The reference movement is terminated.
- i** The switching / blind actuator stores the blind/shutter, slat or louver positions temporarily. After each supply voltage failure (failure of the bus voltage and of the mains voltage) or after programming with the ETS, the actuator therefore automatically performs a reference travel for each output before a new position can be approached.

- i** After bus voltage return, the switching / blind actuator generates an "invalid position" message for each output which can also be transmitted to the bus, if so parameterized. The message is withdrawn (inverted signal value) as soon as a reference movement could be executed.

2.5 Operation

All outputs of the switching / blind actuator can also be operated manually. The button field with 4 function keys and 3 status LEDs on the front panel of the device can be used for setting the following modes of operation...

- Bus control: operation from touch sensors or other bus devices
- Temporary manual control: manual control of the device with keypad, automatic return to bus control,
- Permanent manual control mode: exclusively manual operation of the device with keypad, automatic return to bus control only after manual control is stopped manually.

- i** The operating modes can be enabled or disabled by parameter settings in the ETS.
- i** In manual control mode, the outputs cannot be controlled via the bus.
- i** Manual control is possible only while the actuator is supplied with power from the mains. The manual control mode ends in case of bus voltage return or mains voltage failure.
- i** In manual mode, bus operation can be disabled via a telegram. Manual control is terminated on activation of the disabling function.
- i** Further details concerning the manual mode, especially with respect to the possible parameter settings and the interaction with other functions of the switching / blind actuator can be found in chapter 4 "Software description" of the present documentation.

Controls and indicators for manual control

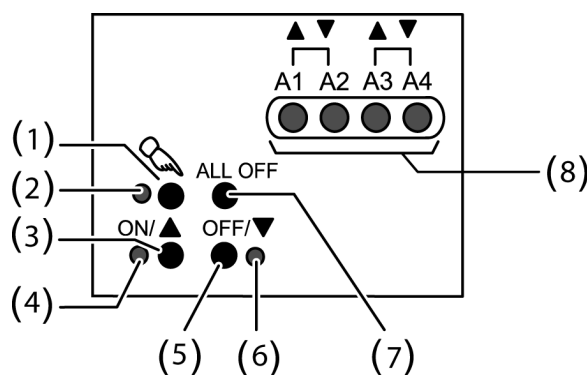

Figure 9: Controls and indicators for manual control for switching / blind actuator 2/4gang

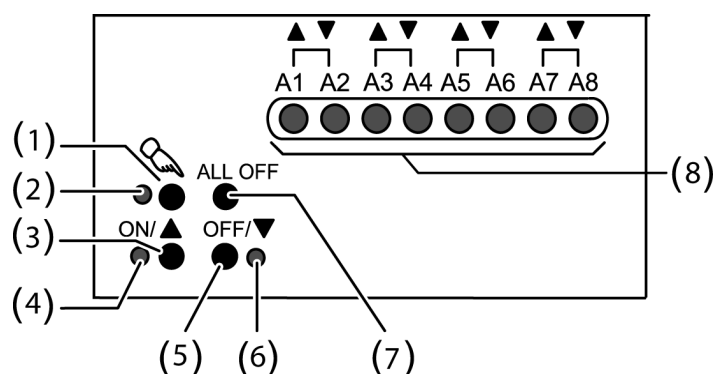

Figure 10: Controls and indicators for manual control for switching / blind actuator 4/8gang

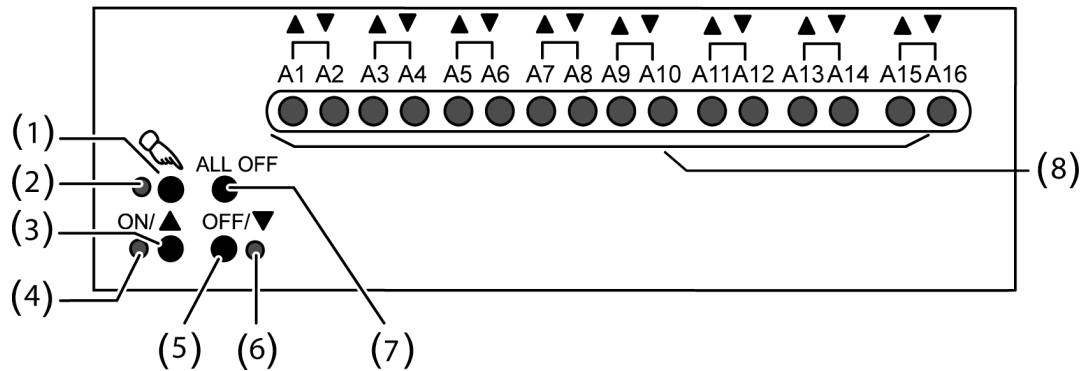

Figure 11: Controls and indicators for manual control for switching / blind actuator 8/16gang

- (1) Button :
Activation / deactivation of manual control.
- (2) LED :
Indicates permanent manual control.
- (3) Button ON/▲
In shutter / blinds operation:
Sustained press (> 1 s) = upward travel output / brief press (< 1 s) = output stop
In switching operation:
Press = output ON
- (4) Status LED ON/ ▲:
LED ON in manual control indicates an active travel movement (up / open) or a switched-on output (relay contact closed).
- (5) Button OFF/ ▼:
In blinds operation: Sustained press (> 1 s) = downward travel output / brief press (< 1 s) = output stop
In switching operation: Press = output OFF
- (6) Status LED OFF/ ▼:
LED ON in manual control indicates an active travel movement (down / close) or a switched-off output (relay contact open).
- (7) Button ALL OFF:
All drives stop / all outputs OFF (only in permanent manual control).
- (8) Status-LEDs ▲/ ▼: LED ON indicates active movements in blinds operation or closed relay contacts in switching operation in the case of activation via the bus or manual operation.

Priorities

The switching / blind actuator distinguishes between different functions that can be active at an output. In order to prevent conflicting states, each available function has a certain priority. The function with the higher priority overrides the function with the lower priority.

For blinds operation there are the following priorities...

- 1st priority: manual control (highest priority),
- 2nd priority: forced position,
- 3rd priority: safety function(s),

Priority levels 4 and 5 can be parameterized in the ETS. The options are then...

- 4th priority: sun protection function,
- 5th priority: direct operation via the bus (STEP/MOVE operation, positioning, scenes, central function),

or...

- 4th priority: direct operation via the bus (STEP/MOVE operation, positioning, scenes, central function),
- 5th priority: sun protection function,

or...

- 4th priority: sun protection function and direct operation via the bus (STEP/MOVE operation, positioning, scenes, central function).

For switching operation there are the following priorities...

- 1st priority: manual control (highest priority)
- 2nd priority: forced position or disabling function
- 3rd priority: logic operation
- 4th priority: direct operation via the bus ("switching" object, scenes, central function)

Switching on the temporary manual control

Manual control is enabled in the ETS.

- Press the  key briefly (< 1 s).

In blinds operation of A1: The 2 status LEDs of A1 flash (LED  remains off).

In switching operation of A1: The status LED of A1 flashes (LED  remains off).



- i** If outputs are parameterized in the ETS to blinds operation, the 2 status LEDs of an output pair always flash. If outputs are parameterized to switching operation, only the status LED corresponding to the selected output flashes. Mixed operation is possible.
- i** After 5 s without a key-press, the actuator returns automatically to bus operation.

Deactivating temporary manual control

Temporary manual control was activated.

- No key-press for 5 s

- or -

- Select all outputs one after another by a brief press of the  button. Thereafter, press the  button again.

- or -

- Switch the mains power supply off or reset the bus (bus voltage return).

Temporary manual control is terminated. The status LEDs A1...A4 / 8 / 16 indicate the status according to bus operation when the mains power supply is switched on.

- i** The state set via manual control is not changed when temporary manual control is switched off. If, however, a function with a priority higher than that of the direct operation (e.g. forced position, disabling function or safety function) has been activated via the bus before or during manual control, the actuator executes the function with the higher priority for the outputs concerned. In switching operation, control via the bus is only interlocked, without carrying out the behaviour at the beginning of the forced or disabling function.

Switching on permanent manual control

Manual control is enabled in the ETS. Bus operation or temporary manual control is active.

- Press the  button for at least 5 s.

The status LED  is illuminated.
In shutter / blinds operation of A1: The two status LEDs of A1 flash.
In switching operation of A1: The status LED of A1 flashes.
Permanent manual control is active:

Deactivating permanent manual control

Permanent manual control is active.

- Press the  key for at least 5 s.

- or -

- Switch the mains power supply off or reset the bus (bus voltage return).

The status LED  goes out. The status LEDs A1...A4 / 8 / 16 indicate the status according to bus operation when the mains power supply is switched on.

- i** Depending on the parameterization of the actuator in the ETS, the outputs will be set to the state last adjusted in the manual mode or to the state internally tracked (direct operation, forced position / disabling function, safety or sun protection position) when the permanent manual mode is shut off.

Controlling an output manually

Manual control (permanent or temporary) is activated.

- Select the desired output: Press the  key briefly (if necessary, repeatedly).
Status LEDs of the selected output A1...A4 / 8 / 16 flash. In blinds operation the LEDs of an output pair flash. Additionally the switching state or a travel movement of the selected output is indicated by the status LED "ON/ ▲" or "OFF/ ▼" in the button field.
- Controlling an output by pressing the operating buttons in the button field.
In shutter / blinds operation:
Brief press (< 1s) button ON/ ▲ or OFF/ ▼: stop drive.
Sustained press (> 1 s) button ON/▲: raise or open drive.
- Sustained press (> 1 s) button OFF/▼: lower or close drive.
In switching operation:
Press button ON/ ▲: switch on (close relay contact).
Press button OFF/▼: switch off (open relay contact).
The selected output executes the corresponding commands immediately.

Shutting off all outputs (in shutter / blinds operation: stopping all drives)

Permanent manual control is active.

- Press the ALL OFF button
All outputs are shut off immediately (stop). The outputs are not locked. Individual activation is again possible after shutoff.
- i** The "ALL-OFF" function is not available in temporary manual control.

Disabling bus control of individual outputs manually

Permanent manual control is active:

Disabling of the bus control mode must have been enabled in the ETS.

- Select the output: Press the  key briefly (if necessary, repeatedly).
Status LEDs of the selected output A1...A4 / 8 / 16 flash. In blinds operation the LEDs of an output pair flash. Additionally the switching state or a travel movement of the selected output is indicated by the status LED "ON/ ▲" or "OFF/ ▼" in the button field."

- Press ON/ ▲ and "OFF/ ▼ buttons simultaneously for at least 5 s.
The output concerned A1...A4 / 8 / 16 is disabled (no bus operation).
The LEDs of the selected output A1...A4 / 8 / 16 flash fast. In blinds operation the LEDs of an output pair flash.
- ⓘ To unlock, proceed in the same way.
- ⓘ An output that has been disabled in manual control can thereafter only be operated in permanent manual control.
- ⓘ If a disabled output is selected in manual control, the LEDs flash twice briefly with a time interval.

3 Technical data

General

Mark of approval	KNX / EIB / VDE
Ambient temperature	-5 ... +45 °C
Storage/transport temperature	-25 ... +70 °C
Weight	
Art. No. 2304.16 REG HE	approx. 250g
Art. No. 2308.16 REG HE	approx. 290g
Art. No. 2316.16 REG HE	approx. 460g
Fitting width	
Art. No. 2304.16 REG HE	72mm / 4modules
Art. No. 2308.16 REG HE	72mm / 4modules
Art. No. 2316.16 REG HE	144mm / 8modules
Installation position	as desired (preferably top output terminals)
Minimum distances	none
Fixing type	Snapping onto top hat rails in closed housing (e.g. small distribution board, etc.)

Terminals for mains supply and outputs

Connection mode	Screw terminal
single stranded	0.5 ... 4 mm ²
finely stranded without conductor sleeve	0.5 ... 4 mm ²
finely stranded with conductor sleeve	0.5 ... 2.5 mm ²
Connection torque	max. 0.8 Nm

KNX supply

KNX medium	TP 1
Commissioning mode	S-mode
Rated voltage KNX	DC 21 ... 32 V SELV
Power consumption KNX	typical 150 mW
Connection mode KNX	Connection terminal

External supply

Rated voltage	AC 230 / 240 V ~
Mains frequency	50 / 60 Hz
Power loss	
Art. No. 2304.16 REG HE	max. 2W
Art. No. 2308.16 REG HE	max. 3W
Art. No. 2316.16 REG HE	max. 4.5W

Outputs (A1...A16)

Contact type	μ contact, monostable
Switching voltage	AC 250 V ~
Switching current AC1	16 A
Switching current AC3	10 A
Fluorescent lamps	16 AX
Switch-on current 200 μs	max. 800 A
Switch-on current 20 ms	max. 165 A
Minimum switching current AC	100 mA
Current carrying capacity	
Neighbouring outputs	Σ 20 A
Device	
Art. No. 2304.16 REG HE	Σ 40A
Art. No. 2308.16 REG HE	Σ 80A
Art. No. 2316.16 REG HE	Σ 160A

Breaking capacity per output (A1...A16)

Ohmic load	3000 W
Capacitive load	max. 16 A (140 μ)
Motors	1380 VA
Lamp loads:	
Incandescent lamps	3000 W
HV halogen lamps	2500 W
LV halogen lamps with Tronic transformer	1500 W
LV halogen lamps with inductive transformer	1200 VA
Compact fluorescent lamps uncompensated	1000 W
Compact fluorescent lamps, parallel compensated	1160 W (140 μ F)
Mercury vapour lamps uncompensated	1000 W
parallel compensated	1160 W (140 μ F)
Fluorescent lamps T5/T8 uncompensated	1000 W
parallel compensated	1160 W (140 μ F)
Duo circuit	2300 W / 140 μ F
Number of electronic ballasts	
T8 lamps	
QTP 2 x 58 W	11
T5 lamps	
QT-FH 4 x 14 W	10
QT-FQ 2 x 54 W	11

i Max. number per output (25.000 switching cycles):

i The number of electronic ballasts that can be connected to the device depends on type and make of the ballast and additionally also on the condition of the low-voltage mains supply network. For this reason, different electronic ballasts are listed as an example (manufacturer: Osram).

4 Software description

4.1 Software specification

ETS search paths:	- Output / Binary output mix / Switching act. 4gang / shutter act. 2gang 16A SE
	- Output / Binary output mix / Switching act. 8gang / shutter act. 4gang 16A SE
	- Output / Binary output mix / Switching act. 16gang / shutter act. 8gang 16A SE
BAU used:	TPUART + μ C
KNX type class:	3b device with cert. Physical layer + stack
Configuration:	S mode standard
PEI type:	"00" _{Hex} / "0" _{Dec}
PEI connector:	No connector

Applications for switching / blind actuator 2/4-gang:

No.	Short description	Name	Version	from mask version
1	Multifunctional switching / shutter application.	Switching, shutter/ blind 20CA11	1.1 for ETS3.0 Version d onwards	705

Applications for switching / blind actuator 4/8-gang:

No.	Short description	Name	Version	from mask version
1	Multifunctional switching / shutter application.	Switching, shutter/ blind 208002	0.2 for ETS 2 and ETS 3.0a...c	705
		Switching, shutter/ blind 208012	1.2 for ETS3.0 version d onwards	

Applications for switching / blind actuator 8/16-gang:

No.	Short description	Name	Version	from mask version
1	Multifunctional switching / shutter application.	Switching, shutter/ blind 207802	0.2 for ETS 2 and ETS 3.0a...c	705
		Switching, shutter/ blind 207812	1.2 for ETS3.0 Version d onwards	

4.2 Software "Switching, shutter/blind 20CA11 / 2078x2 / 2080x2"

4.2.1 Scope of functions

General

- Blinds or switching operation for outputs parameterisable. In blinds operation, two neighbouring outputs are combined respectively into a single blind output. Mixed operation on an actuator is possible.
- Behaviour in case of bus voltage failure and bus voltage return as well as after ETS programming presettable for each output.
- Active feedback telegrams can be globally delayed after bus voltage return.
- Manual control of outputs independent of the bus (for instance, building site operation) with LED status indicators.
- Each output offers the full scope of functions without any restrictions. All channel-oriented functions can be parameterized separately for each output. This feature permits independent and multi-functional control of the switching and shutter/blind outputs.

Shutter/blinds operation

- Operating mode configurable: control of blinds with slats, shutters, awnings or venting louvers.
- Separately configurable blind travelling times with travelling time extension for moves into the upper end position.
- For blinds with slats, a slat moving time can be independently configured
- Travel direction change-over time and the times for short and long-time operation (Step, Move) presettable.
- Central control of all shutter outputs via 1-bit MOVE operation telegram possible.
- Blind/shutter or slat position feedback telegram (only with bus control). In addition, an invalid blind position or an invalid travel movement can be reported back. Active (transmitting after changes or cyclically to the bus) or passive (object readout) feedback functions.
- Assigning of outputs to up to 5 different safety functions (3 wind alarms, 1 rain alarm, 1 frost alarm) optionally with cyclical monitoring. The safety functions (objects, cycle times, priority) are programmed device-oriented and in common for all outputs. The assignment of individual outputs to the safety functions and the safety measures can be parameterized for each channel.
- An extensive sun protection function with fixed and variable blind or slat positions at the beginning and at the end of the function can be activated separately for each output. Dynamic slat offset for slatted blinds included.
- Forced position function can be implemented for each blind output (for switching / blind actuator 8/16 gang only available with ETS3.0d and higher).
- Up to 8 internal scenes configurable per output (for switching / blind actuator 8/16 gang only available with ETS3.0d and higher).

Switching operation

- Independent switching of the switching outputs.
- Can be set to operation as NO contact or NC contact.
- Central switching function with collective feedback.
- Switching feedback mode (only in bus operation): Active (transmitting after changes or cyclically to the bus) or passive (object readout) feedback function.
- Logic function individual for each output.
- Disabling function can be parameterized for each channel. Alternative forced position function separate for each output (forced position function for switching / blind actuator 8/16 gang only available with ETS3.0d and higher).

- Timing functions (switch-on delay, switch-off delay, staircase lighting timer, also with pre-warning function)
- Up to 8 internal scenes are configurable (for switching / blind actuator 8/16 gang only available with ETS3.0d and higher).

4.2.2 Notes on software

ETS configuration and commissioning

For project design and commissioning of the devices, we recommend using the ETS3.0 from Version "d" patch "A" or the ETS4.0. Advantages with regard to downloading (significantly shorter loading times) and parameter programming can be expected only if this ETS versions or later versions are used.

The product database required for the ETS3.0 from version "d" and for the ETS4.0 is offered in the *.VD4 format. The corresponding application program for device versions 4/8 gang and 8/16 gang is version number "1.2". The application program for device versions 2/4 gang is version number "1.1".

For the ETS2 and older versions of the ETS3 separate product databases in the *.VD2 format are only available for device versions 4/8 gang and 8/16 gang. The application program for these ETS versions is version number "0.2".

As far as the scope of functions of the parameters described in this documentation is concerned, the application program for the 8/16 gang actuator differs! Its application program with version number "0.2" does not allow the use of the scene function or the forced positions.

When older ETS versions are updated to the level of version ETS3.0d or to that of later versions, an additional tool in the form of an ETS3 add-in is available. This tool is able to convert older product databases with application version "0.2" – for example from existing ETS2 projects – into the new application format (version "1.2"). This way you can make use of the advantages of the ETS3.0d application easily and without changing the configuration. The ETS3 add-in can be obtained separately and free of charge from the manufacturer.

Safe-state mode

If the device does not work properly - for instance as a result of errors in the project design or during commissioning - the execution of the loaded application program can be halted by activating the safe-state mode. The safe-state mode does not permit controlling the outputs via the bus and by hand. The actuator remains passive since the application program is not being executed (state-of-execution: terminated). Only the system software is still functional so that the ETS diagnosis functions and also programming of the device continue to be possible.

Activating the safe-state mode

- Shut off the bus and the mains voltage supply.
- Press and hold down the programming button.
- Switch on the bus or mains voltage. Release the programming button only after the programming LED starts flashing slowly.

The safe-state mode is activated. With a new brief press of the programming button, the programming mode can be switched on and off as usual also in the safe-state mode. The programming LED will nevertheless continue to flash independently of the programming mode as long as the safe-state mode is active.

- i** The safe-state mode can be terminated by switching off the supply voltage (bus and mains) or by programming with the ETS.

Unloading the application program

The application program can be unloaded with the ETS. In this case, manual control as part of the application program is not available either.

4.2.3 Object table

Number of communication objects:	2/4-gang: 42 (max. object number 57 - gaps in between)
	4/8-gang: 74 (max. object number 109 - gaps in between)
	8/16-gang: 138 (max. object number 213 - gaps in between)
Number of addresses (max):	254
Number of assignments (max):	255
Dynamic table management	No
Maximum table length	255

Channel-independent objects:

Function: Manual operation

Object	Function	Name	Type	DPT	Flag
 ⁰	Disabling	Manual operation	1 bit	1.003	C, W, -, (R) ₁

Description 1-bit object for disabling the buttons for manual control on the device. The polarity can be configured.

Function: Manual operation

Object	Function	Name	Type	DPT	Flag
 ¹	Status	Manual operation	1 bit	1.002	C, -, T, (R) ₁

Description 1-bit object for manual control status transmission. The object is "0", when manual control is deactivated (bus control). The object is "1", when manual control is being activated. You can configure whether the temporary or the permanent manual control will be indicated as status information or not.

Function: Venetian blind central function (Venetian blind operation)

Object	Function	Name	Type	DPT	Flag
 ²	Central movement	All Venetian blind outputs	1 bit	1.008	C, -, T, (R) ₁

Description 1-bit object for central actuation (long-time movement) of assigned Venetian blind outputs. The polarity can be configured.

1: Each communication object can be read out. For reading, the R-flag must be set.

Function: Safety function (Venetian blind operation)

Object	Function	Name	Type	DPT	Flag
 ³	Wind alarm 1	Venetian blind safety	1 bit	1.005	C, -, T, (R) ¹

Description 1-bit object for central activation or deactivation of the first wind alarm("0" = wind alarm deactivated / "1" = wind alarm activated).

Function: Safety function (Venetian blind operation)

Object	Function	Name	Type	DPT	Flag
 ⁴	Wind alarm 2	Venetian blind safety	1 bit	1.005	C, -, T, (R) ¹

Description 1-bit object for central activation or deactivation of the second wind alarm("0" = wind alarm deactivated / "1" = wind alarm activated).

Function: Safety function (Venetian blind operation)

Object	Function	Name	Type	DPT	Flag
 ⁵	Wind alarm 3	Venetian blind safety	1 bit	1.005	C, -, T, (R) ¹

Description 1-bit object for central activation or deactivation of the third wind alarm("0" = wind alarm deactivated / "1" = wind alarm activated).

Function: Safety function (Venetian blind operation)

Object	Function	Name	Type	DPT	Flag
 ⁶	Rain alarm	Venetian blind safety	1 bit	1.005	C, -, T, (R) ₁

Description 1-bit object for central activation or deactivation of the rain alarm ("0" = rain alarm deactivated / "1" = rain alarm activated).

Function: Safety function (Venetian blind operation)

Object	Function	Name	Type	DPT	Flag
 ⁷	Frost alarm	Venetian blind safety	1 bit	1.005	C, -, T, (R) ₁

Description 1-bit object for central activation or deactivation of the frost alarm ("0" = frost alarm deactivated / "1" = frost alarm activated).

Function: Central switching function (switching operation)

Object	Function	Name	Type	DPT	Flag
 ⁸	Central switching	All switching outputs	1 bit	1.001	C, -, T, (R) ₁

Description 1-bit object for central switching of assigned switching outputs. The polarity can be configured.

1: Each communication object can be read out. For reading, the R-flag must be set.

Function: Collective feedback (switching operation)

Object	Function	Name	Type	DPT	Flag
 9	Collective feedback	All switching outputs	4 byte	27.001	C, -, T, (R) 1,2

Description 4-byte object for central feedback of the switching status of the actuator.

Channel-orientated objects for switching mode:

Function: Switching output (switching mode)

Object	Function	Name	Type	DPT	Flag
 10, 23, ..., 205	Switching	Output 1 - 16 ³	1 bit	1.001	C, W, -, (R) 1

Description 1-bit object to control an output ("1" = switch-on / "0" = switch-off; observe the configured operating mode!).

Function: Forced position (switching operation - for switching / blind actuator 8/16 gang only available with ETS3.0d and higher).

Object	Function	Name	Type	DPT	Flag
 11, 24, ..., 206	Forced position	Output 1 - 16 ³	2 bit	2.001	C, W, -, (R) 1

Description 2-bit object for forced control of an output. The object state after bus voltage return can be predefined by means of a parameter.

Function: Disabling function (switching operation)

Object	Function	Name	Type	DPT	Flag
 12, 25, ..., 207	Disabling	Output 1 - 16 ³	1 bit	1.003	C, W, -, (R) 1

Description 1-bit object for disabling an output (polarity configurable).

Function: Logic operation function (switching operation)

Object	Function	Name	Type	DPT	Flag
 13, 26, ..., 208	Logic operation	Output 1 - 16 ³	1 bit	1.003	C, W, -, (R) 1

Description 1-bit object for the input of the logical link of an output. After bus voltage return or after programming with the ETS, the object value can be predefined for each parameter.

1: Each communication object can be read out. For reading, the R-flag must be set.

2: Depending on the configuration, feedback objects are either actively transmitting (T flag set) or passively readable (R flag set).

3: The number of outputs or communication objects depends on the planned device.

Function: Staircase function (switching operation)

Object	Function	Name	Type	DPT	Flag
 14, 27, ..., 209	Staircase function start/stop	Output 1 - 16 ¹	1 bit	1.010	C, W, -, (R) ₂

Description 1-bit object to activate or deactivate the switch-on time of the staircase function of an output ("1" = switch-on / "0" = switch-off).

Function: Scene function (switching operation - for switching / blind actuator 8/16 gang only available with ETS3.0d and higher).

Object	Function	Name	Type	DPT	Flag
 16, 29, ..., 211	Scene extension	Output 1 - 16 ¹	1 byte	18.001	C, W, -, (R) ₂

Description 1-byte object for recalling scenes or for storing new scene values.

Function: Switching status feedback (switching operation)

Object	Function	Name	Type	DPT	Flag
 17, 31, ..., 213	Switching feedback	Output 1 - 16 ¹	1 bit	1.001	C, -, T, (R) _{2,3}

Description 1-bit object for feedback of the switching status of an output ("1" = switched-on / "0" = switched-off; observe the configured operating mode!)

Channel-oriented objects for Venetian blind operation:

Function: Long time operation (Venetian blind operation)

Object	Function	Name	Type	DPT	Flag
 10, 36, ..., 192	Long-time operation	Output 1/2 - 15/16 ₁	1 bit	1.008	C, W, -, (R) ₂

Description 1-bit object for activation of long time operation

Function: Short time operation (Venetian blind operation)

Object	Function	Name	Type	DPT	Flag
 11, 37, ..., 193	Short time operation	Output 1/2 - 15/16 ¹	1 bit	1.007	C, W, -, (R) ₂

Description 1-bit object for activation of short time operation or for stopping a drive movement.

1: The number of outputs or communication objects depends on the planned device.

2: Each communication object can be read out. For reading, the R-flag must be set.

3: The communication flags are set automatically depending on the configuration. "T" flag for active signalling object; "R" flag for passive status object.

Function: Forced position (blinds operation - for switching / blind actuator 8/16 gang only available with ETS3.0d and higher).

Object	Function	Name	Type	DPT	Flag
 12, 38, ..., 194	Forced position	Output 1/2 - 15/16 ₁	2 bit	2.008	C, W, -, (R) ₂

Description 2-bit object for forced control of an output. The object state after bus voltage return can be predefined by means of a parameter.

Function: Scene function (blinds operation - for switching / blind actuator 8/16 gang only available with ETS3.0d and higher).

Object	Function	Name	Type	DPT	Flag
 13, 39, ..., 195	Scene extension	Output 1/2 - 15/16 ₁	1 byte	18.001	C, W, -, (R) ₂

Description 1-byte object for recalling scenes or for storing new scene values.

Function: Sun protection function (Venetian blind operation)

Object	Function	Name	Type	DPT	Flag
 18, 44, ..., 200	Sunshine / shading facade	Output 1/2 - 15/16 ₁	1 bit	1.002	C, W, -, (R) ₂

Description 1-bit object for activation or deactivation of sun shading (sun / no sun). The polarity can be configured.

Function: Sun protection function (Venetian blind operation)

Object	Function	Name	Type	DPT	Flag
 19, 45, ..., 201	Sunsh./shading position ³	Output 1/2 - 15/16 ₁	1 byte	5.001	C, W, -, (R) ₂

Description 1-byte object for presetting a variable position value (0...255) for the height of the Venetian blind or roller shutter height or the venting louver position when the sun protection is active.

Function: Sun protection function (Venetian blind operation)

Object	Function	Name	Type	DPT	Flag
 20, 46, ..., 202	Sunsh./shading slat position	Output 1/2 - 15/16 ₁	1 byte	5.001	C, W, -, (R) ₂

Description 1-byte object for presetting a variable slat position value (0...255) when the sun protection is active.

1: The number of outputs or communication objects depends on the planned device.

2: Each communication object can be read out. For reading, the R-flag must be set.

3: The object designation varies with the type of blind (Venetian blind, roller shutter / awning, venting louver).

Function: Sun protection function (Venetian blind operation)

Object	Function	Name	Type	DPT	Flag
 21, 47, ..., 203	Sunshine slat position offset	Output 1/2 - 15/16 ₁	1 byte	1.003	C, W, -, (R) ₂

Description 1-byte object for presetting a slat position angle (- 100 % ...+100 % - smaller or larger position angles are treated as + or - 100 %) for 'manual' readjustment of the slat position during active sun protection.

Function: Position feedback (Venetian blind operation)

Object	Function	Name	Type	DPT	Flag
 24, 50, ..., 206	Position feedback ^{3,3}	Output 1/2 - 15/16 ¹	1 byte	5.001	C, -, T, R ^{2,4}

Description 1-byte object for position feedback of the Venetian blind or roller shutter height or louver position (0...255).

Function: Position feedback (Venetian blind operation)

Object	Function	Name	Type	DPT	Flag
 25, 51, ..., 207	Slat position feedback	Output 1/2 - 15/16 ¹	1 bit	1.002	C, -, T, R ^{2,4}

Description 1-bit object for reporting back an invalid position of the Venetian blind or roller shutter height or louver position ("0" = position valid / "1" = position invalid).

Function: Invalid position feedback (Venetian blind mode)

Object	Function	Name	Type	DPT	Flag
 26, 52, ..., 208	Invalid position feedback	Output 1/2 - 15/16 ¹	1 bit	1.002	C, -, T, R ^{2,4}

Description 1-bit object for reporting back an invalid position of the blind/shutter curtain height or louver position ("0" = position valid / "1" = position invalid).

Function: Drive movement feedback (Venetian blind mode)

Object	Function	Name	Type	DPT	Flag
 27, 53, ..., 209	Drive movement feedback	Output 1/2 - 15/16 ¹	1 bit	1.002	C, -, T, R ^{2,4}

Description 1-bit object for feedback of an active drive movement (output energised - up or down -"0" = no drive movement / "1" = drive movement).

1: The number of outputs or communication objects depends on the planned device.

2: Each communication object can be read out. For reading, the R-flag must be set.

3: The object designation varies with the type of blind (Venetian blind, roller shutter / awning, venting louver).

4: The communication flags are set automatically depending on the configuration. "T" flag for active signalling object; "R" flag for passive status object.

Function: Presetting the position (Venetian blind operation)

Object	Function	Name	Type	DPT	Flag
□← 28, 54, ... , 210	Position ¹	Output 1/2 - 15/16 ₂	1 byte	5.001	C, W, -, (R) ₃

Description 1-byte object for presetting a position value (0...255) for the height of the Venetian blind or roller shutter or the venting louver position in direct operation.

Function: Presetting the position (Venetian blind operation)

Object	Function	Name	Type	DPT	Flag
□← 29, 55, ... , 211	Slat position	Output 1/2 - 15/16 ²	1 byte	5.001	C, W, -, (R) ₃

Description 1-byte object for presetting a slat position value (0...255) in direct operation.

1: The object designation varies with the type of blind (Venetian blind, roller shutter / awning, venting louver).

2: The number of outputs or communication objects depends on the planned device.

3: Each communication object can be read out. For reading, the R-flag must be set.

4.2.4 Functional description

4.2.4.1 Description of channel-independent functions

Delay after bus voltage return

To reduce telegram traffic on the bus line after bus voltage activation (bus reset), after connection of the device to the bus line or after programming with the ETS, it is possible to delay all actively transmitted feedback telegrams of the actuator. For this purpose, a channel-independent delay can be specified (parameter "Delay after bus voltage return" on parameter page "General". Only after the configured time elapses are feedback telegrams for initialisation transmitted to the bus.

Which of the feedback telegrams is actually delayed and which is not can be specified for each output channel and for each feedback function separately.

- i** The delay has no effect on the behaviour of the outputs. Only the feedback telegrams are delayed. The outputs can also be activated during the delay after bus voltage return.
- i** A setting of "0" for the delay after bus voltage return deactivates the delaying function altogether. In this case, all feedback telegrams, if actively transmitted, will be transmitted to the bus without any delay.
- i** When switching on the mains voltage (bus voltage is not switched on at this time), the feedback telegrams will always be transmitted without any delay.

Central function for switching outputs

The actuator offers the possibility of linking selected individual or all switching output channels with a 1-bit central communication object. The behaviour in case of activating an output via the central function is comparable to a central group address linked with all "Switching" objects.

The outputs assigned to the central function are activated in accordance with the central object value received. If necessary, the polarity of the central telegram can be configured as inverted.

The behaviour of the channels is identical with the 'normal' activation via the "Switch" objects. (same priority – last switching command is executed (figure 12)). Thus, all 'downstream' functions, such as timing/supplementary functions or logic operations, are also taken into account. The parameterised relay operation is also evaluated separately for each output.

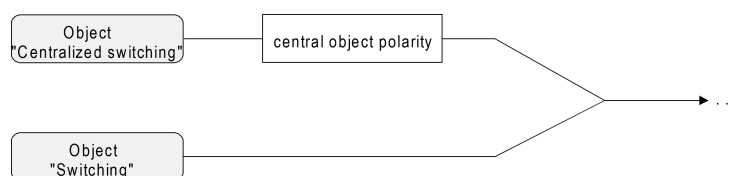

Figure 12: Function diagram "Central switching"

Enabling the central function

- Enable the central function on parameter page "General switching outputs" by setting the "Central function for switching outputs ?" to "Yes".

If a function is active, the "Central switching" communication object is visible.

Assigning switching outputs to the central function.

Each switching-output can be assigned independently to the central function.

The central function must have been enabled on parameter page "General switching outputs". The assignment has otherwise no effect on the switching output.

- Set the "Assignment to central function" parameter on the "Ax-General" page (x = number of output) to "Yes".

The appropriate output is assigned to the central function. It can be switched on or off centrally.

- i** The switching state set by the central function is tracked in the feedback objects and also transmitted to the bus, if these are actively transmitting. The switching state set by a central function is not tracked in the "switching" objects.
- i** After a bus voltage return or after programming with the ETS, the central function is always inactive (object value "0").

Central function for shutter/blind outputs

The actuator offers the possibility of linking selected individual or all output channels with a 1-bit central communication object. The behaviour in case of activating an output via the central function is comparable to a central group address linked with all "Long time operation" objects. The outputs assigned to the central function are activated in accordance with the central object value received. If necessary, the polarity of the central telegram can be configured as inverted. The behaviour of the channels is identical with the 'normal' activation via the "Long-time operation" objects (same priority – last command is executed - (figure 13)).

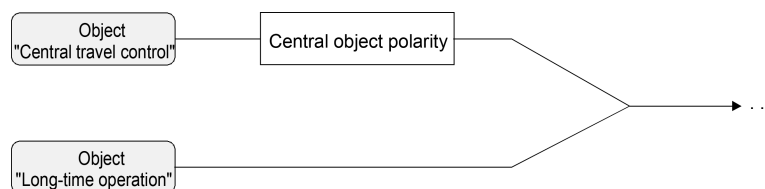

Figure 13: Function diagram "Central movement"

Enabling the central function

- Enable the central function on parameter page "General" by setting the "Central function for blind outputs?" parameter to "Yes".

If a function is active, the "Central movement" communication object is visible.

Assigning outputs to the central function

Each output can be assigned independently to the central function.

The central function must have been enabled on parameter page "General". The assignment has otherwise no effect on the Venetian blind output.

- Set the "Assignment to central function" parameter on parameter page "Ax-Enabled functions" (x = number pair of output) to "Yes".

The appropriate output is assigned to the central function. It can be moved centrally.

- i** The blind, venting louvre or slat position newly set by the central function is tracked at the end of a travel movement in the feedback objects and also transmitted to the bus, if these are actively transmitting. It should be noted that the switching / blind actuator can compute positions after application of the supply voltage only if a reference movement into the upper limit positions has been performed beforehand.

- i** The central function belongs to the set of 'direct operations' of an output. For this reason, the central function has the same priority compared with operation using the short time or long time objects, used to control the positioning objects or to recall scenes.
- i** After a bus voltage return or after programming with the ETS, the central function is always inactive (object value "0").

Collective feedback for switching outputs

After central commands or after bus voltage return, a bus line is generally heavily loaded by data traffic as many bus devices are transmitting the state of their communication objects by means of feedback telegrams. This effect occurs particularly when using visualisations. To keep the telegram load low during 'bus initialisation', collective feedback of the actuator can be used.

The collective feedback summarises the switching status of all switching outputs in just one telegram. The 32 bit communication object "Collective feedback" contains bit-orientated feedback information of the individual outputs (figure 14).

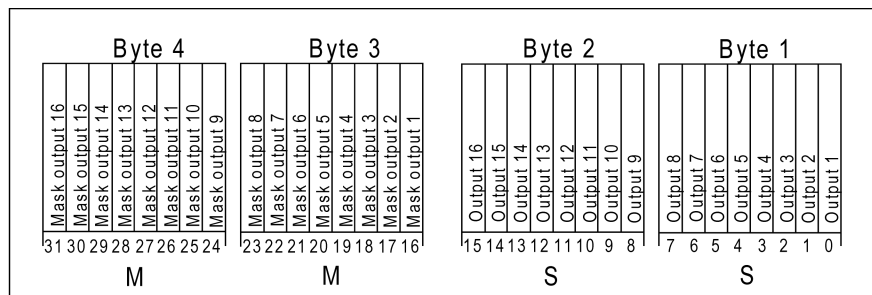

Figure 14: Object structure of the collective feedback

It is possible to show up to 16 outputs and thus up to 16 different switching states logically. with each output having one bit representing the switching state ("S" bit) and another one defining the masking ("M" bit). The "S" bits correspond to the logical non-inverted switching states of the outputs and are either "1" (switched on) or "0" (switched off). The "M" bits are "1" when the actuator possesses this output. Likewise, the "M" bits are "0" when the appropriate output is not available on the actuator or the channel is configured as blind output. In the latter cases, the corresponding "S" bits are continuously "0" because there is no switching status.

This produces the following object value formats when all outputs, for example, are set to switching operation...

switching / blind actuator 2/4-gang: "00 0F 00 0x", x = switching states,
 switching / blind actuator 4/8-gang: "00 FF 00 xx", xx = switching states,
 Switching / blind actuator 8/16-gang "FF FF xx xx", xx xx = switching states.

The datapoint type of the collective feedback corresponds to the KNX standard (DPT 27.001). The application would be possible in appropriate visualisation applications - for example in public buildings such as schools or hospitals - where the switching states of the actuators are displayed centrally and no status is displayed at the control points. In such applications the collective feedback can replace the 1 bit individual feedbacks and thereby significantly reduce the bus load.

Activate collective feedback

The collective feedback can be used as an active message object or as a passive status object. As an active message object, the collective feedback information is transmitted to the bus whenever a switching state changes. As a passive status object, there is no telegram

transmission after a change. In this case, the object value must be read out. The ETS automatically sets the object communication flags required for proper functioning.

- Preset the "Use collective feedback" parameter "?" to "Yes, active message object" or "Yes, passive status object" according to the required function.

The 4-byte communication object "Collective feedback" is enabled. Once a group address is linked, the object can be used.

Activating collective feedback on return of bus voltage or after programming with the ETS

If used as active message object, the collective feedback is transmitted to the bus after bus voltage return or after programming with the ETS. In these cases, the feedback telegram can be time-delayed with the delay being preset globally for all outputs together (see "Delay after bus voltage return").

- Set the parameter "Time delay for feedback telegram after bus voltage return" of the collective feedback to "Yes".
The collective feedback telegram is transmitted with a delay after bus voltage return or after programming in ETS. No feedback telegram is transmitted during a running delay, even if a switching state changes during this delay.
- Set the parameter "Time delay for feedback telegram after bus voltage return" of the collective feedback to "No".
The collective feedback telegram is transmitted immediately after bus voltage return or ETS programming.

Setting cyclic transmission of the collective feedback

The collective feedback telegram can also be transmitted cyclically via the actively transmitting message object in addition to the transmission after changes.

- Set the parameter "Cyclic transmission of the collective feedback ?" on the parameter page "General" to "Yes".
Cyclical transmission is activated.
- Set the parameter "Cyclic transmission of the collective feedback ?" on the parameter page "General" to "No".
Cyclical transmission is deactivated which means that a collective feedback telegram is transmitted to the bus only if one of the switching states changes.

i The cycle time for all cyclic feedback telegrams is defined centrally on the parameter page "General".

i During an active delay after bus voltage return no collective feedback telegram will be transmitted even if a switching state changes.

i A 'flashing' output (see "Disabling function") is always reported as "switched on".

Manual operation

All outputs of the switching / blind actuator can also be operated manually. The button field with 4 function keys and 3 status LEDs on the front panel of the device can be used for setting the following modes of operation...

- Bus control: operation from touch sensors or other bus devices
- Temporary manual control: manual control locally with keypad, automatic return to bus control,
- Permanent manual control: local manual control with keypad.

The operation of the function keys, the control of the outputs and the status display are described in detail in chapter "2.5 Manual control".

The parameterisation, status feedback, disabling via a bus telegram, and interaction with other

functions of the switching / blind actuator when manual control is activated and deactivated are described in greater detail below.

Manual control is possible only while the actuator is supplied with power from the mains. The switching / blind actuator is delivered with the manual control mode fully enabled. In this unprogrammed state, the individual outputs can be switched on and off also without bus voltage so that fast function checking of the connected drives (e.g. on the construction site) is possible.

After initial commissioning of the actuator via the ETS, manual control can be enabled or disabled separately for various states of operation. Manual control can, for instance, be disabled during bus operation (bus voltage applied). Another option consists in the complete disabling of the manual control only in case of bus voltage failure. Therefore manual control can be disabled completely, if the bus disable and bus failure disable are active.

Enabling the manual control mode

Manual control for the different states of operation is enabled or disabled by means of the parameters "Manual control in case of bus voltage failure" and "Manual control during bus operation".

- Set the parameter "Manual control in case of bus voltage failure" to "enabled".
Manual control is then basically enabled when the bus voltage is off. This setting corresponds to the setting of the actuator as delivered.
 - Set the parameter "Manual control in case of bus voltage failure" to "disabled".
Manual control is completely disabled when the bus voltage is off. In this case, bus operation is not possible either so that the outputs of the actuator can no longer be activated.
 - Set the parameter "Manual control during bus operation" to "enabled".
Manual control is then basically enabled when the bus voltage is on. The outputs of the actuator can be activated via the bus or manually. This setting corresponds to the setting of the actuator as delivered.
 - Set the parameter "Manual control during bus operation" to "disabled".
Manual control is completely disabled when the bus voltage is on. In this configuration, the actuator outputs can only be operated via the bus.
- i** Further parameters and communication objects of the manual control are visible only in the configuration "Manual control during bus operation = enabled". For this reason, the disabling function, the status message and bus control disabling can only be configured in the above parameter setting.

Presetting the behaviour at the beginning and at the end of manual control.

The manual control distinguishes the temporary and permanent manual control. The behaviour is different depending on these modes of operation, especially at the end of manual control. It should be noted that the operation via the bus, i.e. control of the outputs by direct operation (switch / move / step / position / scene / central) or by the sun protection function, disabling, forced position or safety functions, is always disabled when manual control is active. This means that the manual control mode has the highest priority.

Behaviour at the beginning of manual control:

The behaviour at the beginning of manual control does not differ for temporary and permanent manual control. When manual control is activated, all travel movements that were started beforehand by bus control for the venetian blind outputs will still be completed unless the travel movement in question is stopped by hand. Switching states of switching outputs will be maintained.

Active forced-positions, disabling, safety and sun protection functions can be overridden by manual operation. These functions are reactivated after deactivation of the manual mode unless they have been cancelled in the meantime.

Behaviour at the end of manual control:

The behaviour at the end of manual control is different for temporary and permanent manual control.

The temporary manual mode is shut off automatically when the last output has been addressed and when the select key  is pressed once more. During a deactivation of the temporary manual control mode, the actuator goes back to 'normal' bus operation and does not change the state selected by manual control. If, however, a forced position, safety, disabling or sun protection function (independent of priority) has been activated via the bus before or during manual control, the actuator executes these functions of a higher priority again for the outputs concerned.

Permanent manual control is switched off if selection button  is pressed for longer than 5 s. Depending on the parameterization of the actuator in the ETS, the outputs will be set to the state last adjusted in the manual mode or to the state internally tracked (direct operation, forced position, disabling, safety or sun protection position) when the permanent manual mode is switched off. The parameter "Behaviour at the end of permanent manual control during bus operation" defines the corresponding reaction.



- Set the parameter "Behaviour at the end of permanent manual control during bus operation" to "no change".

All telegrams received during an active permanent manual control mode for direct operation (switching, long-time/short-time, positioning, central, scenes) will be rejected. After the end of the permanent manual control mode, the current state of all outputs remains unchanged.

If, however, a forced position, safety, disabling or sun protection function (independent of priority) has been activated via the bus before or during manual control, the actuator executes these functions of a higher priority again for the outputs concerned.

- Set the parameter "Behaviour at the end of permanent manual control during bus operation" to "track outputs".

During an active permanent manual control, all incoming telegrams (blinds operation exception: short-time telegrams – step/stop) are internally tracked. At the end of the manual operation mode, the outputs will be set to the tracked states or to the absolute positions last set before the permanent manual operation mode for blinds inputs. Long time operation is not tracked if the corresponding blinds output is already in the appropriate end position.

-  The behaviour at the end of the permanent manual control when the bus voltage is off (only manual control) is permanently set to "no change".
-  The control operations triggered in the manual control mode will be transmitted via feedback objects to the bus, if enabled and actively transmitting.
-  On return of bus voltage or after programming with the ETS, an activated manual control mode will always be terminated. In this case, the parameterised or preset behaviour at the end of a manual operation is not executed. The actuator executes the parameterized behaviour on bus voltage return or after ETS programming instead.

Presetting a manual control disable

The manual control mode can be separately disabled via the bus, even if it is already active. If the disabling function is enabled, then as soon as a disabling telegram is received via the disabling object of the manual control, the actuator immediately terminates an activated manual control and locks the function keys on the front panel of the device. The telegram polarity of the disabling object is parameterisable.

The manual control mode during bus operation must be enabled in the ETS.

- Set the parameter "Disabling function ?" on parameter page "Manual control" to "yes".

The disabling function of the manual control mode is enabled and the disabling object is visible.

- Select the desired telegram polarity in the "Disabling object polarity" parameter.
- i** If the polarity is "0 = disabled; 1 = enabled", the disabling function is immediately active on return of bus voltage or after an ETS programming operation (object value "0"). To activate the manual control in this case, an enable telegram "1" must first be sent to the disabling object.
- i** In case of bus voltage failure, disabling via the disabling object is always inactive (depending on parameterization, the manual control is then either enabled or completely disabled). After return of bus voltage a disabled state that was active before will be reactivated. The disabled state will be deactivated only after an enabling telegram has been received.
- i** In the event of failure of the supply voltage (bus voltage and mains voltage failure) the disable is deactivated via the disabling object. Merely the interruption of the mains voltage supply does not affect the disabling of manual control.
- i** When an active manual control is terminated by a disable, the actuator will also transmit a "Manual control inactive" status telegram to the bus, if the status messaging function is enabled.

Presetting the status message function for the manual control mode

An actuator can transmit a status telegram to the bus via a separate object when the manual operation is activated or deactivated. The status telegram can only be transmitted when the bus voltage is present. The polarity of the status telegram can be parameterised.

The manual control mode during bus operation must be enabled.

- Set the parameter "Transmit status ?" on parameter page "Manual control" to "yes".
The status messaging function of manual control is enabled and the status object is visible.
- Specify in the parameter "Status object function and polarity" whether the status telegram is generally a "1" telegram whenever the manual control mode is activated or only in those cases where the permanent manual mode is activated.
- i** The status object is always "0" when the manual control mode is deactivated.
- i** After bus voltage return, the status will only be transmitted actively to the bus ("0") if a manual control, activated during a bus voltage failure, is ended by the bus return. The status telegram is in this case transmitted without delay.
After bus voltage return or after programming with the ETS, the value of the status object is "0" and can also be read out.
- i** When active manual control is terminated by a disable function of the manual operation, the actuator will also transmit a "Manual control inactive" status telegram to the bus.

Setting disabling of the bus control

Individual switching or venetian blind outputs can be disabled locally, so that the disabled outputs can no longer be controlled via the bus. Such disabling of the bus operation is initiated by operation in permanent manual control and is indicated by rapid flashing of the status LEDs of the outputs concerned. The disabled outputs can then only be activated in permanent manual control.

The manual control mode during bus operation must be enabled in the ETS.

- Set the parameter "Disable bus control of individual outputs during bus operation" on parameter page "Manual control" to "yes".
The function for disabling the bus control is enabled and can be activated locally. As an alternative, this parameter can be set to "no" to prevent activation of disabling of the bus control in permanent manual control.

- i** The disabling initiated locally has the highest priority. Thus all other functions of the actuator that can be activated via the bus (e.g. forced position, disabling or safety function) are overridden.
Depending on the parameterization of the actuator in the ETS, the outputs will be set to the state last adjusted in the manual mode or to the state internally tracked (direct operation, forced position, disabling, safety or sun protection position) when the permanent manual mode is reactivated and subsequently shut off.
- i** Any disabling of the bus control activated locally is not reset in case of bus voltage failure or return. Even a mains voltage failure does not by itself reset the disabling. A failure of the supply voltage (bus and mains voltage failure) does deactivate the disabling of the bus control.

Safety functions for venetian blind outputs

The switching/ venetian blind actuator can handle up to five different safety functions for the venetian blind outputs. Each safety function has a communication object of its own so that the functions can be activated or deactivated independently of one another.

There are three different wind alarms available. These alarms can be used, for instance, to protect Venetian blinds or awnings on several building facades from wind and gusts. In addition or as an alternative, a rain alarm, for instance, as a protection for awnings, and a frost alarm as a protection against mechanical damage to lowered Venetian blinds in low temperatures can be activated and used. The telegram polarity of the safety objects is fixed:

"0" = No alarm / "1" = Alarm.

Usually, weather stations, which record temperature, wind speed and rain via the sensors, control the communication objects of the safety function.

The safety functions are programmed and configured in common for all shutter/blind outputs.

The different venetian blind outputs of the actuator can be separately assigned to all or to individual safety functions. Only assigned outputs respond to a change in the state of the safety objects. The reactions at the beginning of an alarm message ("1" telegram) or at the end of an alarm message ("0" telegram) can be parameterized for each channel.

Because outputs are also assigned to multiple safety alarms, the priority of incoming alarm messages can be preset for several channels. Thus, the three wind alarms have the same priority with respect to one another (logic OR). The order of priority of the wind alarms with respect to the frost alarm or to the rain alarm can be parameterized.

The communication objects for the safety alarms can be monitored for the arrival of cyclical telegrams. If there are no telegrams within a settable monitoring time, the device activates the safety movement for the output. The safety function is terminated as soon as a new "0" telegram is received.

For the wind alarms, the rain alarm and the frost alarm, different monitoring times between '1 minute' and '23 hours 59 minutes' can be separately selected in the ETS. A shared time is configured for the wind alarms. Each wind alarm has its own timer so that the wind objects are separately checked for telegram updates.

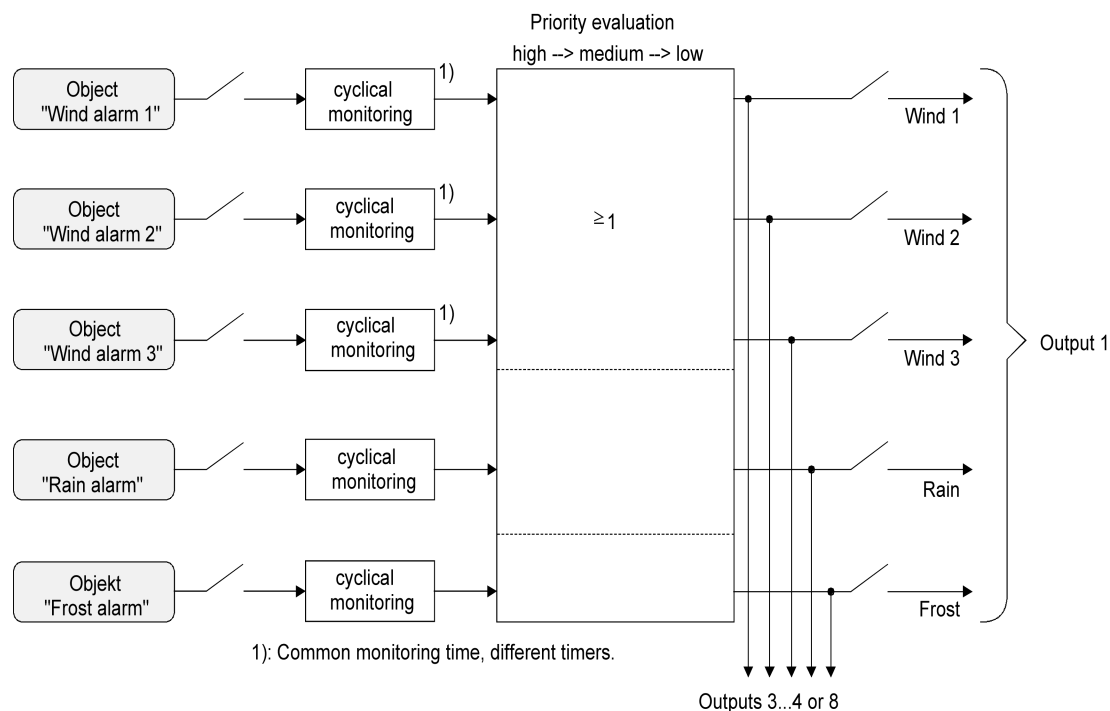

Figure 15: Function diagram of safety functions

Enabling the safety functions

The safety functions must first be globally enabled before they can be parameterized and used. After global enabling, the individual safety alarms can be enabled or disabled independently of one another.

- Set the parameter "Safety functions" on the "Venetian blind output safety" parameter page to "enabled".

The safety functions are globally enabled and the other parameters and the parameter page "Venetian blind safety times" become visible.

- Set the parameters "Wind alarm 1", "Wind alarm 2", "Wind alarm 3", "Rain alarm" and "Frost alarm" depending on functional requirements to "enabled". The "disabled" option deactivates the corresponding alarm.

The necessary safety alarms are now enabled. The safety objects are visible and can be linked with group addresses.

- i** It should be noted that the channel-oriented assignment of shutter outputs to the safety alarms (on parameter pages "Ax – Safety"; x = number pair of output) is operational only after the corresponding alarm has been enabled as well. Otherwise, an assignment is without function.
- i** An update of the safety objects ("ON" to "ON" or "OFF" to "OFF") shows no reaction.
- i** After failure of the supply voltage (bus and mains voltage failure) or after programming with the ETS, the safety functions are always deactivated. If only the mains voltage or only the bus voltage fails, the object states of the safety functions are not lost and the functions remain activated, if they were activated before. In this case it should be noted, however, that the configured behaviour will be executed when the bus or mains voltage returns (parameter "Behaviour after bus or mains voltage return"). After such action, the outputs are, however, safety-locked and cannot be operated via the bus anymore unless the safety functions assigned are terminated.

Presetting the safety priorities

If several safety alarms are assigned to an output, it is important to preset the priority of the incoming safety telegrams. In so doing, an alarm with a higher priority overrides the alarms with the lower priorities. When safety alarm with the higher priority has ended, the safety alarm with the lower priority is executed on condition that it is active.

The safety functions must have been globally enabled.

- Set the "Priority of safety alarms" parameters on the "Venetian blind outputs safety" parameter page to the required order of priority.
- i** The three wind alarms have the same priority with respect to one another (logic OR). The last telegram update to the wind alarm objects decides which of the wind alarms will be executed. The wind alarm is completely deactivated for an assigned output only after all three objects are inactive ("0").

Presetting cyclical monitoring

If cyclical telegram monitoring of the safety objects is necessary, the individual monitoring functions must be activated separately. The monitoring functions must be enabled and the monitoring times preset on the "Venetian blind safety times" parameter page.

The safety functions must have been globally enabled.

- If monitoring of the wind alarms is to be activated, the parameter "Use wind alarm monitoring function ?" must be set to "yes".
The monitoring function for the wind alarm objects is now activated. As soon as the monitoring function is activated, telegrams must be transmitted cyclically to all enabled wind alarm objects. If only one of the wind alarm telegrams is missing within the monitoring period, the wind alarm reaction will be executed for the output concerned.
- Specify the required monitoring time for the wind alarm objects in the "Wind alarm monitoring times" parameters.

- If the monitoring function is to be activated for a rain alarm, the parameter "Use rain alarm monitoring function ?" must be set to "yes".
The monitoring function for the rain alarm object is now activated. As soon as the monitoring function is activated, telegrams must be transmitted cyclically to the rain alarm object.
- Specify the required monitoring time for the rain alarm object in the "Rain alarm monitoring times" parameters.

- If the monitoring function is to be activated for a frost alarm, the parameter "Use frost alarm monitoring function ?" must be set to "yes".
The monitoring function for the frost alarm object is now activated. As soon as the monitoring function is activated, telegrams must be transmitted cyclically to the frost alarm object.
- Specify the required monitoring time for the frost alarm object in the "Frost alarm monitoring times" parameters.
- i** The monitoring function for the wind alarms may only be activated, if at least one wind alarm has been activated on the "Venetian blind outputs safety" page.
- i** The cycle time of the transmitters should be shorter than the monitoring time parameterized in the switching/shutter actuator in order to ensure that at least one telegram can be received during the monitoring time.

Setting of the channel definition

Relay outputs of the switching/shutter actuator can be set in the ETS software configuration either to blinds operation or alternatively to switching operation; mixed operation of these channel definitions for the various outputs of the device is possible.

In blinds operation the relay contacts of the switching / blind actuator can be used to control electrically driven blinds, shutters, awnings, venting louvers or similar curtains for 230 V AC mains voltage. Alternatively, the actuator can switch electrical loads, such as lighting systems or low voltages in switching operation.

The channel definition can be configured separately for each output pair on the "Select Switching - shutter/blind" parameter page. Depending on this setting, all the channel-dependent parameters and objects are created in the ETS and made visible.

Depending on the set channel definition the outputs can either be configured separately (switching operation e.g. A1, A2, A3, A4,...) or are combined into output pairs (Venetian blind operation e.g. A1/2, A3/4,...). The names of the output objects and the parameter page change accordingly. The outputs are combined as described also in the manual control mode.

In Venetian blind operation, each respective output of the output pair activates one of the travel directions (e.g. A1 – up / A2 – down). The travel directions are locked against each other by the application software of the actuator in order to rule out the possibility of activating both travel directions simultaneously in fault-free operation of the switching / blind actuator.

Configuring channel definition



CAUTION!

Operating the actuator outside of its technical specifications (see "Technical data") can cause relay contacts to weld together.

Danger of destruction of the connected drives if relay contacts weld together, as a result of which both travel directions are energized at the same time.

Operate the actuator exclusively within its technical specifications!

A mechanical locking of the travel directions is not implemented since the outputs must be controllable separately in switching operation, too.

- Set the parameter "output x and output y" (x = 1, 3, 5,.../ y = 2, 4, 6,...) to "1 x blind output".
The appropriate output pair is configured to blind operation. Both outputs are combined into one blind channel.
- Set the parameter "output x and output y" (x = 1, 3, 5,.../ y = 2, 4, 6,...) to "2 x switching output".
The appropriate output pair is configured to switching operation. Both outputs are programmed separately as two switching channels.



The parameter and object configurations of the individual outputs depend on the parameters on the "Select Switching - shutter/blind" page and are readjusted by the ETS when the channel definition is reconfigured. Consequently, parameter settings or group address assignments to objects can be lost. For this reason, the channel definition should be reset when beginning the parameterization of the actuator.

4.2.4.2 Channel-oriented functional description

4.2.4.2.1 Functional description of the switching outputs

Operating mode

The relays of a switching output can be parameterized as make or break contacts. In this way, the inversion of switching states is possible. The operating mode set also affects the switching status feedbacks.

Presetting the mode of operation

The parameter "Mode of operation" exists separately for each output channel on the parameter page "Ax General" (x = number of output).

- Reset operating mode as NO contact.
Switching state = off ("0") -> relay contact open,
Switching state = on ("1") -> relay contact closed.
- Reset operating mode as NC contact.
Switching state = off ("0") -> relay contact closed,
Switching state = on ("1") -> relay contact open.

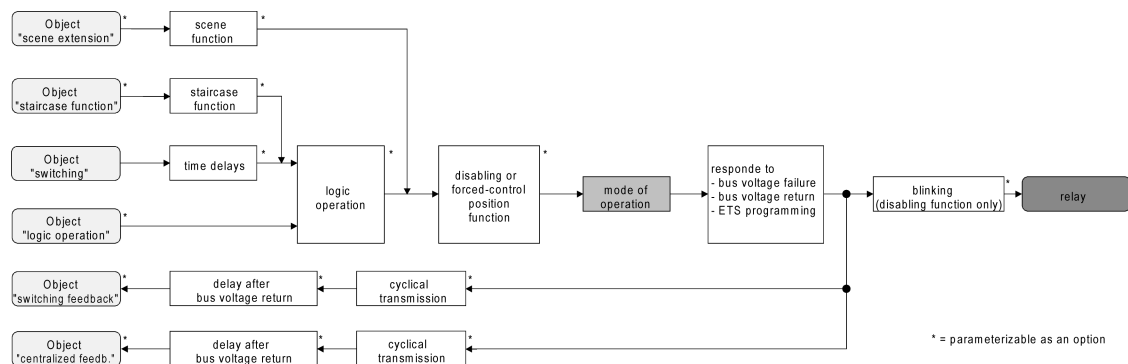

Figure 16: Function diagram "Operating mode"

- i** The logic switching state ("on - 1" or "off - 0") is set by the communication object "Switching" and influenced by the functions that can be optionally activated (e.g. timing/ staircase functions, logic operations, disabling/forced-control position functions, scenes) (figure 16).
- i** A switching state set after bus or mains voltage return or after an ETS programming operation is added to the feedback object. In the event of a mains voltage failure, switching status feedback telegrams are transmitted to the bus if the bus voltage is still switched on. In this case, it should be noted that regardless of the preset operating mode (NO contact or NC contact) all outputs are initialised with the switching state "switched off - 0" and the feedback telegram is thus adapted to this state, too.

Behaviour in case of bus voltage failure, after bus or mains voltage return or after programming with the ETS

The preferred relay contact positions after bus voltage return or after ETS programming can be preset separately for each output. Since the actuator is equipped with mains-dependent monostable relays, the relay switching state at bus voltage failure can be defined as well.

Presetting the behaviour after ETS programming

The parameter "Behaviour after ETS programming" can be preset separately for each output channel on the parameter page "Ax General" (x = number of output). This parameter can be used to configure the relay behaviour of the output, irrespective of the behaviour after bus voltage return.

- Set the parameter to "no reaction".
After ETS programming, the relay of the output shows no response and remains in the switching state last selected. The internal logical switching state is not lost by the ETS programming operation.
- Set the parameter to "Close contact".
The relay contact closes after an ETS programming operation
- Set the parameter to "Open contact".
The relay contact opens after an ETS programming operation
- i** The configured behaviour will be executed after every application or parameter download by the ETS. A simple download of the physical address alone or partial programming of only the group addresses has the effect that this parameter is disregarded and that the configured "Behaviour after bus or mains voltage return" will be executed instead.
- i** Programming with the ETS is possible when the bus voltage line is connected to the switching / blind actuator and the bus voltage supply is on. The mains voltage supply is not required for an ETS download.
- i** During each ETS programming operation, the switching / blind actuator always opens the relay contacts for all venetian blind outputs. For this reason, a closed relay contact can be opened temporarily even in the "no reaction" setting.
- i** A switching state set after an ETS programming cycle – taken into account by the "operating mode" parameter – is added to the feedback object.
- i** An active manual mode will be terminated by an ETS programming operation.
- i** After an ETS programming operation, the disabling functions and the forced-positions are always deactivated.

Presetting the behaviour in case of bus voltage failure

The parameter "Behaviour in case of bus voltage failure" can be preset separately for each output channel under "Ax General" (X = number of output).

- Set the parameter to "no reaction".
In case of bus voltage failure, the relay of the output shows no reaction and remains in the switching state last selected provided that the mains voltage supply of the actuator is still switched on.
- Set the parameter to "Close contact".
In case of bus voltage failure, the relay contact closes provided that the mains voltage supply of the actuator is still switched on.
- Set the parameter to "Open contact".
The relay contact opens in case of bus voltage failure.
- i** With the settings "close contact" and "open contact", time delays or previously recalled scenes do not have any affect on the output affected in case of bus voltage failure. A telegram update received shortly before bus voltage failure is then lost, if the corresponding delay has not yet elapsed.
With the setting "no reaction", all time delays that have started (time delay, delayed scene recall) are still evaluated even after the bus voltage failure, provided that the mains voltage supply is still switched on. The state of an output can thereby still change even after a bus failure.

- i** In the event of a failure of the mains voltage supply, all relays of the actuator always drop out (contact open), regardless of the state of the bus voltage. In this state the outputs can no longer be activated. Time functions (scene, time delays) are not interrupted, if only the mains voltage supply fails.
In the event of a mains voltage failure, switching status feedback telegrams are transmitted to the bus if the bus voltage is still switched on. In this case, it should be noted that regardless of the preset operating mode (NO contact or NC contact) all outputs are initialised with the switching state "switched off and the feedback telegram is thus adapted to this state, too.
- i** In the event of a bus failure or mains voltage failure, the current states of the forced-positions are also saved so that they can be tracked in the event of bus voltage return if necessary (depending on the parameterization of the forced positions).
- i** Active disabling functions or forced position functions are always cancelled by a bus voltage failure and are subsequently inactive in the connection.

- i** When there is a bus or supply voltage failure, the current switching states are saved internally, so that these states can be accurately preset after bus or supply voltage return, should this be configured. The data are stored before the reaction parameterized for the case of bus voltage failure takes place and only if one part of the supply (mains or bus) is still present, or if the supply fails completely after the mains voltage has been available before without interruption for at least 20 seconds after the last reset (storage capacitors sufficiently charged for storage purposes). The saving process is performed only once after the failure of one part of the supply voltage...

Example 1:

Bus voltage failure -> Data storage -> Then mains voltage failure -> No further data storage,

Example 2:

Mains voltage failure -> Data storage -> Then bus voltage failure -> No further data storage.

Because the switching states are saved only once in the event of bus voltage failure, states that are changed after a bus voltage failure, for example via manual control, are not tracked!

Behaviour after bus or mains voltage return presetting

The parameter "Behaviour after bus or mains voltage return" can be preset separately for each output channel on the parameter page "Ax General" (x = number of output).

- Set the parameter to "Close contact".
The relay contact closes after bus or mains voltage return.
 - Set the parameter to "Open contact".
The relay contact opens after bus or mains voltage return.
 - Preset parameter to "state as before bus/mains voltage failure".
After bus or mains voltage return, the switching state last existing and internally stored before bus or mains voltage failure will be tracked.
 - Preset parameter to "Activate staircase function (if parameterized)".
The staircase function is – irrespective of the 'Switching' object - activated after bus or mains voltage return. With this setting you should note that the staircase function is also enabled and programmed. When the staircase function is not enabled, there is no reaction after bus/mains voltage return with this setting.
- i** In the setting "State before bus/mains voltage failure": An ETS programming operation of the application or the parameter resets the internally stored switching state to "off - 0".

- i** The device only executes the configured "Behaviour after bus or mains voltage return" if the last ETS programming of the application or parameters ended at least approx. 20 s prior to switching on the bus voltage. Otherwise ($T_{ETS} < 20$ s), the "Behaviour after ETS programming" will be adopted also in case of bus voltage return.
If just the mains voltage fails after an ETS download and is then restored, the actuator executes the "Behaviour after bus or mains voltage return".
A mains voltage return does not influence the communication objects that receive states from the bus (e.g. logic operation inputs). The objects remain on the last set state if the bus voltage was connected interruption free.
- i** In the case of forced position as supplementary function: The communication object of the forced position can be initialised separately after bus voltage return. This has an effect on the reaction of the output when the forced position is activated. The configured "Behaviour in the case of bus or mains voltage return" will only be executed if no forced position is activated after bus voltage return.
A failure of the mains voltage of the actuator always deactivates a forced position.
- i** In the case of enabling function as supplementary function: Active disabling functions are always inactive after bus or mains voltage return.
- i** A switching state set a after bus or mains voltage return – taken into account by the "operating mode" parameter – is added to the feedback object.
- i** After return of bus voltage a manual control will be interrupted.. In case of mains failure, no manual control is possible.

Switching status feedback

The actuator can report the switching status selected on the output ("switched on" or "switched off") back to the bus (figure 17). The feedback value can be inverted optionally.

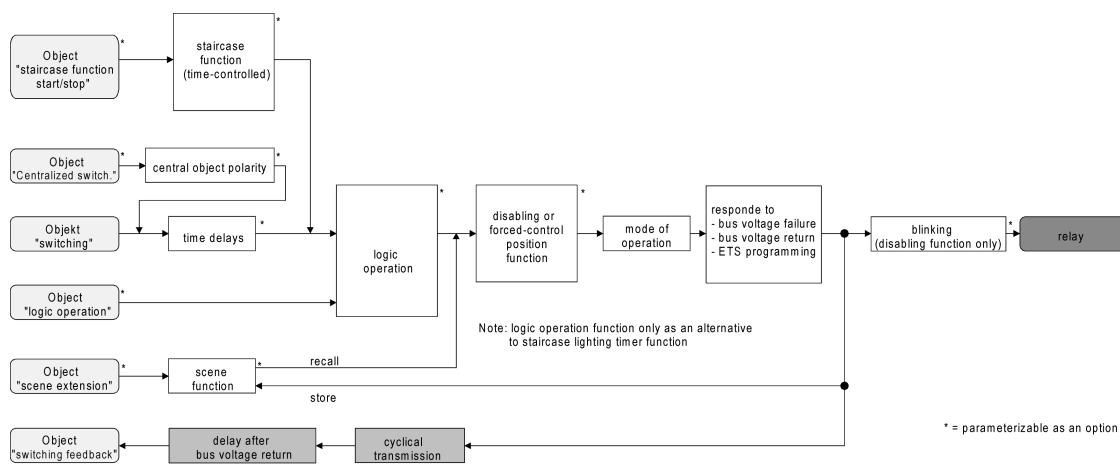

Figure 17: Functional feedback diagram

Activating switching status feedback

The switching status feedback can be used as an active message object or as a passive status object. As an active message object, the switching status feedback information is transmitted to the bus whenever a switching state changes. As a passive status object, there is no telegram transmission after a change. In this case, the object value must be read out. The ETS automatically sets the object communication flags required for proper functioning. The parameter "Feedback telegram?" can be preset separately for each output channel on the parameter page "Ax - General" (x = number of output).

- Preset parameter to "do not invert, active message object" or "invert, active message object".

The feedback object is enabled. As soon as there is a change of state or after the device was programmed by the ETS, the switching status is transmitted non-inverted or inverted, depending on the setting. Telegram transmission of the switching status feedback takes place after bus or mains voltage return as well

- Preset parameter to "do not invert, passive status object" or "invert, passive status object".
The feedback object is enabled. The switching status will be transmitted in response only if the feedback object is read out by the bus, depending on the setting non-inverted or inverted. No automatic telegram transmission takes place after bus or mains voltage return or after programming with the ETS.
- i** In case of actively transmitting objects, all status updates from "ON" to "ON" or from "OFF" to "OFF" via the object "Switching" or the object "Central switching" always cause a feedback telegram to be transmitted. If a delay is preset and if the switching state is changed via the object "Switching", the delay period must have elapsed before the feedback will be updated.
- i** Switching state changes are also reported back to the bus by manual operation.
- i** In the case of enabling function as supplementary function: A 'flashing' output (see "Disabling function") is always reported as "switched on". Switching status feedbacks are also transmitted for disabled outputs when the outputs are readjusted by a manual operation, for example.

Activating switching status feedback on return of bus voltage or after programming with the ETS

If used as active message object, the switching status feedback information is transmitted to the bus after bus voltage return or after programming with the ETS. In these cases, the feedback telegram can be time-delayed with the delay being preset globally for all outputs together (see "Delay after bus voltage return").

- Set the parameter "Time delay for feedback telegram delay after bus voltage return" on parameter page "Ax General" (x = number of output) to "Yes".
The switching status telegram will be transmitted with a delay after bus voltage return or after programming with the ETS. No feedback telegram is transmitted during a running delay, even if a switching state changes during this delay.
- Set the parameter "Time delay for feedback telegram delay after bus voltage return" on parameter page "Ax General" (x = number of output) to "No".
The switching status telegram will be transmitted immediately after bus voltage return or after programming with the ETS.
- i** In case of a feedback telegram after bus voltage return or after programming with the ETS, the parameterized mode of operation will be evaluated. Examples for a non-inverted switching status feedback telegram:
Mode of operation make contact: contact closed = feedback "on",
Mode of operation make contact: contact opened = feedback "off",
Mode of operation break contact: contact closed = feedback "off",
Mode of operation break contact: contact opened = feedback "on".
- i** When switching on the mains voltage (bus voltage is not switched on at this time), the feedback telegrams will always be transmitted without any delay.

Presetting the cyclical transmission function for the switching status feedback telegram

The switching status feedback telegram can also be transmitted cyclically via the active message object in addition to the transmission after changes.

- Set the parameter "Cyclical transmission of feedback telegram?" on parameter page "Ax General" (x = number of output) to "Yes".
Cyclical transmission is activated.
- Set the parameter "Cyclical transmission of feedback telegram?" on parameter page "Ax General" (x = number of output) to "No".

Cyclical transmission is deactivated, which means that a feedback telegram is transmitted to the bus only if switching state changes.

- i** The cycle time is defined centrally on the parameter page "Switching outputs times".
- i** During an active delay after bus voltage return no feedback telegram will be transmitted even if a switching state changes.

Time delays

Up to two time functions can be preset for each switching output independent of each other. The time functions affect the communication objects "switching" or "central switching" only (if a central function is activated for the output concerned) and delay the object value received depending on the telegram polarity (figure 18).

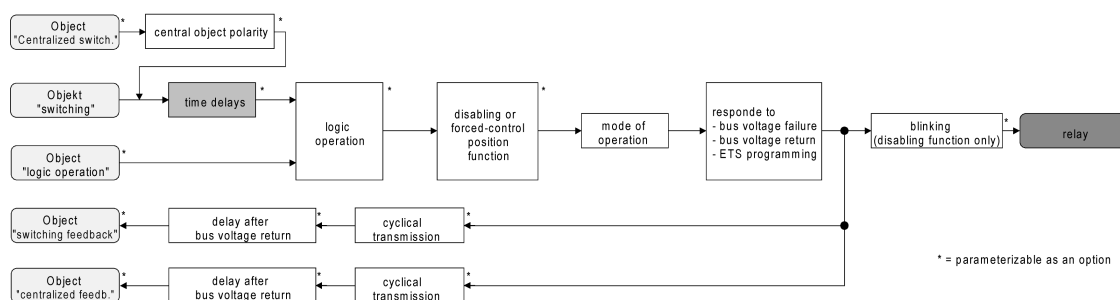

Figure 18: Function diagram of the time delays

activating switch-on delay

The time delays must have been enabled on parameter page "Ax – Enabled functions (x = number of output).

- On parameter page "Ax – time delays", preset the parameter "selection of time delay" to "switch-on delay" or to "switch-on delay and switch-off delay".

The switch-on delay is enabled. The desired switch-on delay time can be specified. After reception of an ON-telegram, a configurable time is started. Another ON-telegram triggers the time only when the parameter "Switch-on delay retriggerable ?" is set to "Yes". The logical switching state will then be transferred to the following functions (e.g. logical operation, disabling / forced-control position function) and the output switched on, only after the ON-delay has elapsed. An OFF-telegram received during the ON-delay will end the delay. The logical switching state corresponds in this case to "switched off".

Activate switch-off delay

The time delays must have been enabled on parameter page "Ax – Enabled functions (x = number of output).

- On parameter page "Ax – time delays", preset the parameter "selection of time delay" to "switch-off delay" or to "switch-on delay and switch-off delay".

The switch-off delay is enabled. The desired switch-off delay can be preset. After reception of an OFF-telegram, a configurable time is started. Another OFF-telegram triggers the time only when the parameter "switch-off delay retriggerable ?" is set to "Yes". The logical switching state will then be transferred to the following functions (e.g. logical operation, disabling / forced-control position function) and the output switched off, only after the OFF-delay has elapsed. An ON-telegram received during the OFF-delay will end the delay. The logical switching state corresponds in this case to "switched on".

- i** Feedback: If a time delay has been preset and if the switching state is changed via the "Switching" object, the time delay must have elapsed before feedback telegrams will be transmitted. Updates of the object from "ON" to "ON" or from "OFF" to "OFF" by retriggering during a running time delay has no influence on the switching status feedback.
- i** At the end of a disabling function or forced position function, the state received during the function or adjusted before the function can be tracked. Residual times of time functions are also tracked if these had not yet fully elapsed at the time of the reactivation or forced control. A switching state newly received via the "switching" object is evaluated with a time delay also in the switching operation.
- i** The time delays do not influence the staircase function if this is enabled.
- i** A time delay still in progress will be fully aborted by a reset of the actuator (bus voltage failure or ETS programming).

Staircase function

The staircase function that can be configured separately for each output can be used for implementing time-controlled lighting of a staircase or for function-related applications. The staircase function must be enabled on parameter page "Ax - Enabling functions" for each output in order for the required communication objects and parameters (on the parameter page "Ax - staircase function") to be visible.

The staircase function is activated via the communication object "staircase function start / stop" and is independent of the "switching" object of the output (figure 19). In this way, 'parallel operation' of time control and normal control is possible, whereby the last command received is always executed:

A telegram to the "switching" object or a scene recall at the time of an active staircase function aborts the staircase time prematurely and presets the switching state according to the received object value (the time delays are also taken into account) or scene value. Similarly, the switching state of the "switching" object or a scene recall can be overridden by a staircase function.

The staircase function, according to the function diagram, can also be combined with other functions of the output. A combination with the logic operation function is not possible, however.

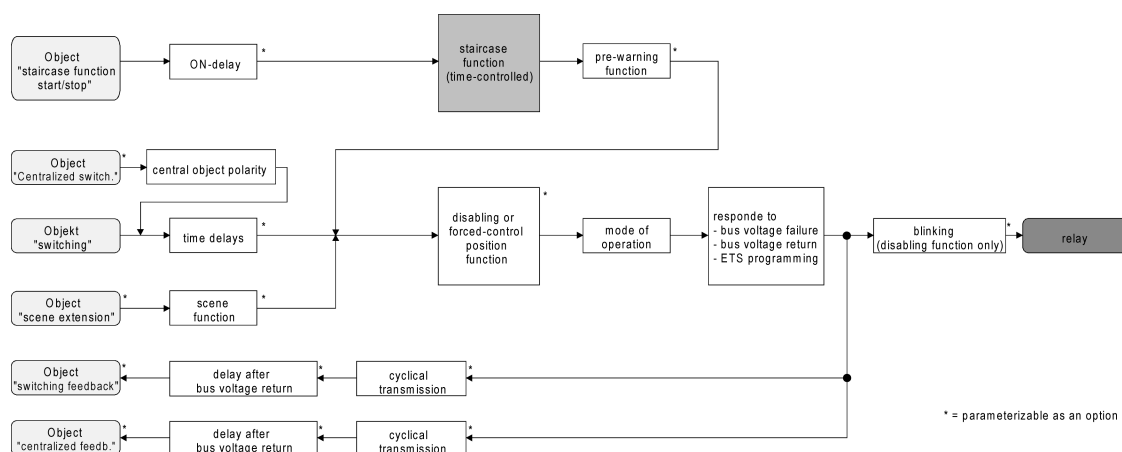

Figure 19: Function diagram of the staircase function

The staircase function can be extended by means of a separate switch-on delay and pre-warning function. The pre-warning function should, according to DIN 18015-2, warn any person still on the staircase that the light will soon be switched off.

Specifying switch-on behaviour of the staircase function

An ON telegram to the "staircase function start/stop" object activates the staircase time (T_{EIN}), the duration of which is defined by the "staircase time" parameters. In addition, a switch-on delay (T_{Verz}) can be activated (see "presetting switch-on delay of the staircase function"). At the end of the staircase time, the output switches off or activates optionally the pre-warning time ($T_{Vorwarn}$) of the pre-warning function (see "presetting pre-warning function of the staircase function"). Taking into account any possible switch-on delay and pre-warning function, this gives rise to the switch-on behaviour of the staircase function as shown in the following diagram.

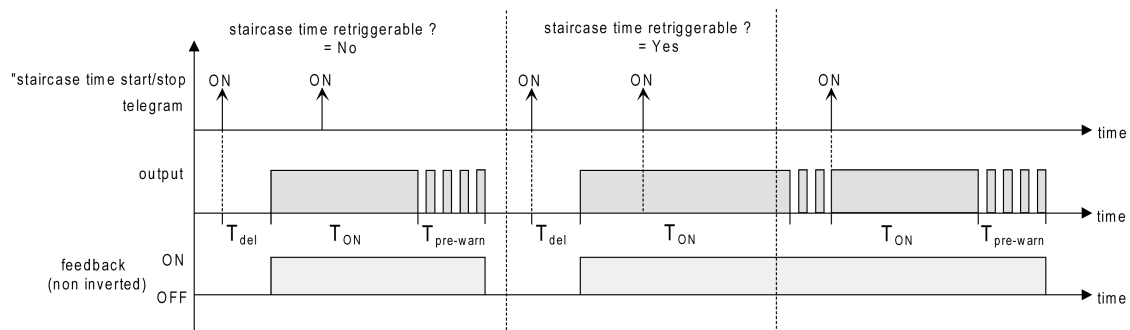

Figure 20: Switch-on behaviour of the staircase function

The parameter "Staircase time retriggeable ?" defines whether the staircase time can be retrigged.

The staircase function must have been enabled on parameter page "Ax – Enabled functions (x = number of switching output).

- Parameter "Staircase time retriggeable ?" preset to "Yes".
Every ON telegram received during the ON phase of the staircase time retriggers the staircase time completely.
 - Parameter "Staircase time retriggeable ?" preset to "no".
ON telegrams received during the ON phase of the staircase time are rejected. The staircase time is not retrigged.
- i** An ON telegram received during the warning time triggers the staircase time independently of the parameter "staircase time retriggeable ?" always afterwards.
- i** When the supplementary function "time extension" is preset, the parameter "staircase time retriggeable ?" cannot be changed. In this case, it is permanently set to "No".

Specifying switch-off behaviour of the staircase function

In the case of a staircase function, the reaction to an OFF telegram is also configurable on the object "staircase function start/stop". Without the receipt of an OFF telegram the output switches off after the pre-warning time elapses, if necessary Taking into account any possible switch-on delay and pre-warning function, this gives rise to the switch-off behaviour of the staircase function as shown in the following diagram.

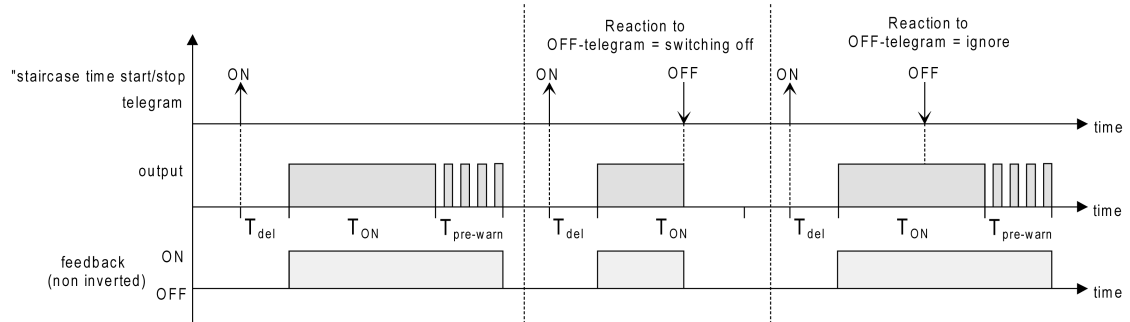

Figure 21: Switch-off behaviour of the staircase function

The parameter "reaction to OFF-telegram" defines whether the staircase time (T_{EIN}) of the staircase function can be aborted prematurely.

The staircase function must have been enabled on parameter page "Ax – Enabled functions (x = number of output)".

- Set parameter "Reaction to OFF-telegram" to "switch off".
As soon as an OFF telegram is received via the object "Staircase function start/stop" during the ON phase of the staircase time, the output switches off immediately. If the staircase time is stopped prematurely by such a telegram, there is no pre-warning, i.e. the pre-warning time is not started.
- Set parameter "Reaction to OFF-telegram" to ignore".
OFF telegrams received during the ON phase of the staircase time are rejected. The staircase time will be executed completely to the end with pre-warning if necessary.

Setting the switch-on delay of the staircase function

An ON telegram for activation of the staircase function can also be evaluated with a time delay. This switch-on delay can be activated separately for the staircase function and has no influence on the configurable time delays for the object "switching".

The staircase function must have been enabled on parameter page "Ax – Enabled functions (x = number of output)".

- Set the parameter "switch-on delay for the staircase function ?" on parameter page "AX – staircase function" to "Yes". auf "Ja" einstellen.
The switch-on delay for the staircase function is enabled. The desired switch-on delay time can be specified. After reception of an ON telegram on the object "Staircase function start/stop", the switch-on delay is started. Another ON-telegram triggers the time only when the parameter "Switch-on delay retriggerable" is set to "Yes". The staircase time is activated and the output is switched on only after the time delay has elapsed.

i An OFF telegram via the object "Staircase function start/stop" during the switch-on delay only terminates the delay if the parameter "Reaction to OFF-telegram" is set to "switch off". Otherwise, the OFF telegram is ignored.

Setting the pre-warning function of the staircase function

The pre-warning should, according to DIN 18015-2, warn persons still on the staircase that the light will soon be switched off. The lighting connected on the output is briefly switched off repeatedly as a pre-warning, before the output is switched off permanently. At the same time, the pre-warning time ($T_{Vorwarn}$), the duration of the interruptions during the pre-warning ($T_{Unterbr}$) and the number of pre-warning interruptions are configurable (figure 22). The pre-warning time is added to the staircase time (T_{EIN}). The pre-warning time influences the value of the feedback object so that the value "0" (in the case of non-inverted transmission) is first tracked after the pre-warning time in the feedback object has elapsed.

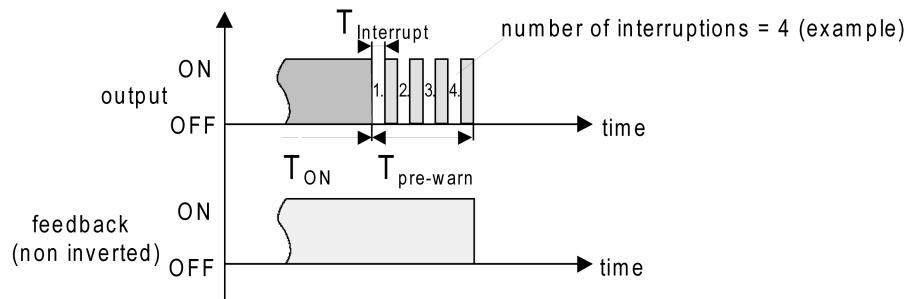

Figure 22: The pre-warning function of the staircase function (example)

The staircase function must have been enabled on parameter page "Ax – Enabled functions (x = number of output).

- Set the parameter "activate pre-warning time ?" on the parameter page "Ax – staircase function" to "Yes".

The pre-warning function is enabled. The desired pre-warning time ($T_{Vorwarn}$) can be preset.

- Set the parameter "number of pre-warnings" on the parameter page "Ax – staircase function" to the desired value (1... 10).

Within the pre-warning time, the lighting connected on the output is switched off just as often as configured here. The 1st pre-warning is always executed at the beginning of the entire pre-warning time.

- Set the parameters "time for pre-warning interruptions" on the parameter page "Ax – staircase function" to the desired value.

An interruption ($T_{Unterbr}$) during the pre-warning time is just as long as configured here. The adjustable interruption time allows the switch-off phase of the lighting to be adapted individually to the lamps used.

- i** It should be noted that the "number of pre-warnings" and the "time for pre-warning interruptions" must be attuned to the duration of the entire "pre-warning time". Hence, the entire switch-off phase during a pre-warning ("number of pre-warnings" + "time for pre-warning interruptions") must not be set longer than the pre-warning time! Otherwise, malfunctions can be expected.
- i** An ON telegram to the object "Staircase function start/stop" while a pre-warning function is in progress stops the pre-warning time and always starts (independently of the parameter "staircase time retriggerable ?") the staircase time anew. Even during the pre-warning time, the parameter "reaction to OFF telegram" is evaluated so that a pre-warning in progress can be terminated early by switching off.

Setting the behaviour of the staircase function after bus voltage return

The staircase function can optionally be started automatically after bus voltage return.

The staircase function must have been enabled on parameter page "Ax – Enabled functions (x = number of output).

- Set the parameter "Behaviour after bus or mains voltage return" on the parameter page "Ax – General" to "activate staircase function".

Immediately after bus or mains voltage return, the staircase time of the staircase function is started.

- i** With this setting you should note that the staircase function is also enabled and programmed. When the staircase function is not enabled, there is no reaction after bus/ mains voltage return with this setting.
- i** During automatic starting of the staircase function after bus/mains voltage return, no switch-on delay is started if the staircase function has configured such a delay.

- i** The device only executes the configured "Behaviour during bus or mains voltage return" if the last ETS programming of the application or of the parameters ended at least approx. 20 s prior to switching on the bus voltage. Otherwise ($T_{ETS} < 20$ s), the "Behaviour after ETS programming" will be adopted also in case of bus voltage return.
If just the mains voltage fails after an ETS download and is then restored, the actuator executes the "Behaviour after bus or mains voltage return".
- i** The configured behaviour will only be executed, if no forced position on bus voltage return is activated.
- i** A switching state set a after bus or mains voltage return – taken into account by the "operating mode" parameter – is added to the feedback object.

Scene function (for switching / blind actuator 8/16 gang only available with ETS3.0d and higher).

Up to 8 scenes can be programmed and scene values stored separately in the actuator for each switching output. The scene values are recalled or stored via a separate scene extension object by means of extension telegrams. The datapoint type of the extension object permits addressing a maximum of 64 scenes. This means that, in the configuration of a scene, it is possible to specify which scene number (1...64) contacts the internal scene (1...8).

The scene function must be enabled on parameter page "Ax - Enabling functions" for each output in order for the required communication objects and parameters (on the parameter page "Ax - Scenes") to be visible.

The scene function can be combined together with other functions of the output (figure 23), whereby the last received or preset command is always executed:

A telegram to the "switching" object, a scene recall or scene storage telegram at the time of an active staircase function aborts the staircase time prematurely and presets the switching state according to the received object value (time delays are also taken into account) or scene value. Similarly, the switching state of the output, which was preset by the "switching" object or by a scene recall, can be overridden by a staircase function or by a new result of the logic operation function.

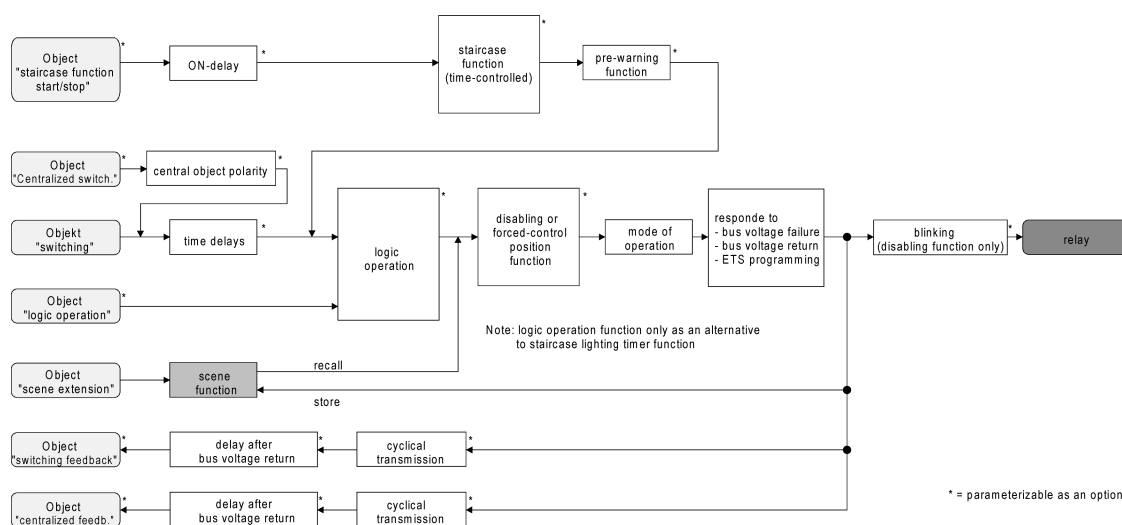

Figure 23: Function diagram of the scene function

Presetting a scene recall delay for the scene function

Each scene recall of an output can optionally also be delayed. With this feature, dynamical scene sequences can be configured if several outputs are combined with cyclical scene telegrams.

The scene function must have been enabled on parameter page "Ax – Enabled functions (x = number of output).

- Set the parameter "Delay scene recall?" on parameter page "Ax – Scenes" to "yes".
The delay time is now activated and can be configured separately. The delay only influences the scene recall of the output. The delay time is started on arrival of a recall telegram. The corresponding scene will be recalled and the output set to the switching state value only after this time has elapsed.
- ⓘ Each scene recall telegram restarts the delay time and retriggers it. If a new scene recall telegram is received while a delay is active (scene recall not yet executed), the old (and not yet recalled scene) will be rejected and only the scene last received executed.
- ⓘ The scene recall delay has no influence on the storage of scene values. A scene storage telegram within a scene recall delay terminates the delay and thus the scene recall.

Presetting the ETS download behaviour for the scene function

During storage of a scene, the scene values are stored permanently in the device (see "Presetting the storage behaviour for scene functions"). To prevent the stored values from being replaced during ETS programming of the application or parameters by the originally programmed scene switching states, the actuator can inhibit overwriting of the scene values. As an alternative, the original values can be reloaded into the device during each programming run of the ETS.

The scene function must have been enabled on parameter page "Ax – Enabled functions (x = number of switching output).

- Set the parameter "Overwrite the values stored in the device during ETS download ?" on parameter page "Ax – Scenes" to "Yes".
During each ETS programming of the application or of the parameters, the scene values parameterized in the ETS for the output concerned will be programmed into the actuator. Scene values stored in the device by means of a storage function will be overwritten, if any.
- Set the parameter "Overwrite the values stored in the device during ETS download ?" on parameter page "Ax – Scenes" to "No".
Scene values stored in the device with a storage function will be maintained. If no scene values have been stored, the switching commands last programmed in the ETS remain valid.
- ⓘ When the actuator is put into operation for the first time, this parameter should be set to "yes" so that the output is initialized with valid scene values. Otherwise, the values in the actuator are "0" for all scenes (switched off).

Presetting scene numbers and scene switching state for scene function

The datapoint type of the scene extension object permits addressing of up to 64 scenes max. For this reason, the scene number (1...64) with which the scene is addressed, i.e. recalled or stored, must be determined for each internal scene (1...8) of the output. Moreover, the switching state to be set for the output in case of a scene recall must be specified as well.

The scene function must have been enabled on parameter page "Ax – Enabled functions (x = number of output).

- Set the parameter "Scene x activatable by scene number" (x = number of the scene (1...8)) for each scene on parameter page "Ax – Scenes" to the numbers with which the scenes are to be addressed.

Szenen angesprochen werden sollen. A scene can be addressed with the configured scene number. A setting of "0" deactivates the corresponding scene so that neither recalling nor storage is possible.

- i** If the same scene number is parameterized for several scenes, only the scene with the lowest internal scene number (1...8) will be addressed. The other internal scenes will be ignored in this case.

- Set the parameter "Switching state for scene x" (x = number of the scene (1...8)) on parameter page "Ax – Scenes" for each scene to the desired switching command ("on" or "off").
With a scene recall the parameterized switching command is recalled and set on output.
- i** The switching command is only set on output during a scene recall if no forced position or disabling function is activated.
- i** The parameterized switching command is adopted in the actuator during programming with the ETS only if the parameter "Overwrite values stored in the device during ETS download ?" is set to "Yes".

Presetting the storage behaviour for the scene function

The logical switching state ("switched on" or "switched off") preset on the output according to the function diagram can be stored internally via the extension object on reception of a scene storage telegram. In this case, the switching state can be influenced before the storage by all functions of the output provided the individual functions have been enabled (e.g. also the disabling function, forced-control position function, manual control, etc.).

Rule of thumb: The logical state stored is the one that is reported to the bus by the non-inverted feedback telegram or the one that would have been reported back to the bus had the feedback function not been disabled.

The scene function must have been enabled on parameter page "Ax – Enabled functions (x = number of output).

- Set the parameter "Storage function for scene x" (x = number of the scene (1...8)) on parameter page "Ax – Scenes" for each scene to "Yes".
The storage function is activated for the scene in question. On reception of a storage telegram via the "Scene extension" object, the current logical switching state will be internally stored.
- Set the parameter "Storage function for scene x" (x = number of the scene (1...8)) on parameter page "Ax – Scenes" for each scene to "No".
The storage function is deactivated for the scene in question. A storage telegram received via the "scene extension" object will be rejected.

Supplementary function

Supplementary functions can be enabled for each switching output. Configurable as supplementary function is a disabling function or alternatively a forced position function (for switching / blind actuator 8/16 gang only available with ETS3.0d and higher). In this respect, only one of these functions can be enabled for one output. Additionally, a logic operation function can be parameterized.

These supplementary functions are enabled on parameter page "Ax – Supplementary functions" (x = number of output).

Setting disabling function as supplementary function

The disabling function, according to the function diagram (figure 24), can also be combined with other functions of the output. With an active disabled state the upstream functions are overridden so that the output concerned is locked in the disabling position. Continuous light switching can also be overridden.

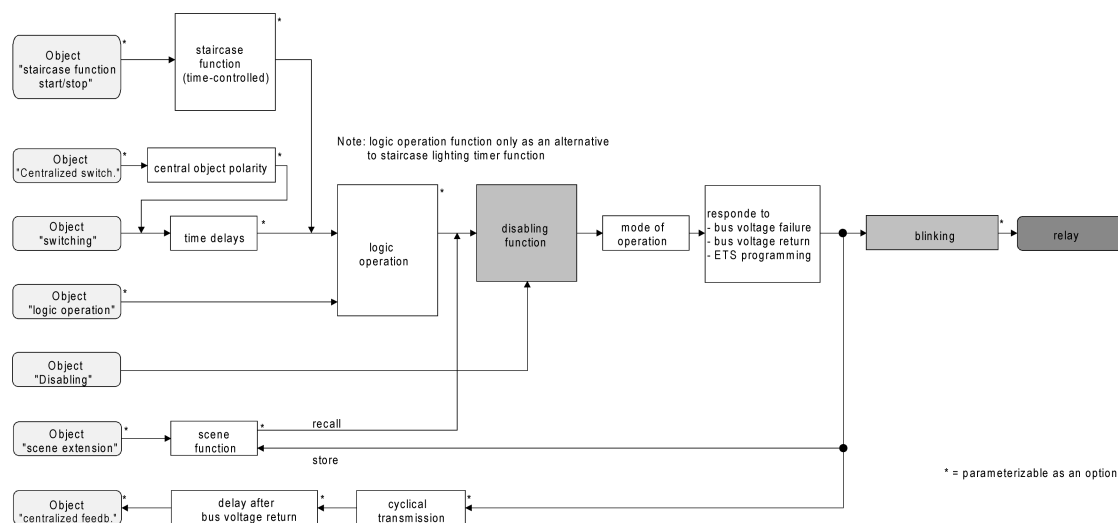

Figure 24: Function diagram of the disabling function

- On the parameter page "Ax - supplementary functions", set the parameter "selection of supplementary function" to "disabling function".
The disabling function is enabled. The communication object "Disable" and the parameters of the disabling function become visible.
- On the parameter page "Ax - supplementary functions", set the parameter "polarity disabling object" to the desired polarity.
- i** After a bus failure or mains voltage failure or programming the application or the parameters with the ETS, the disabling function is always deactivated (object value "0"). With the inverted setting "1 = enabled; 0 = disabled", a telegram update "0" must first be carried out after the initialisation until the disabling is activated.
- i** Updates of the disabling object from "ON" to "ON or "OFF" to "OFF" do not produce a reaction. The relay remains in the position last set, if applicable also set manually.
- i** An output disabled via the bus can be still be operated manually!

- On the parameter page "Ax - supplementary functions", set the parameter "setting the behaviour at the beginning of the disabling function" to the required behaviour.
At the beginning of the disabling function, the configured behaviour will be executed and the output locked. When the setting "No change of switching state" is selected, the relay of the output shows no reaction and remains in the switching state last set (switching state in acc. with last non-inverted feedback telegram). In the "flashing" setting, the output is switched on and off cyclically during the disabling. The flashing time is configured generally for all outputs on the parameter page "General". During the flashing, the logical switching state is "ON 1".
- On the parameter page "Ax - supplementary functions", set the parameter "setting the behaviour at the end of the disabling function" to the required behaviour.

At the end of the disabling function, the configured behaviour will be executed and the output enabled again. When the setting "No change of switching state" is selected, the relay of the output shows no reaction and remains in the state last set by the disabling function.

In "set tracked state", the last switching state existing before the disabling function or the switching state internally tracked during the disabling function will be set. At the same time, residual times of time functions or of the staircase function are also tracked if these had not yet fully elapsed at the time of the reactivation. With the settings "no change of switching state", "switch on", "switch off" or "flashing" the states set at the end of the disabling function have no effect on the time or staircase functions.

In the "flashing" setting, the output is switched on and off cyclically after the disabling. The flashing continues until a new switching state is specified. The flashing time is configured generally for all outputs on the parameter page "General". During the flashing, the logical switching state is "ON 1".

- i** The states specified at the end of a disabling function override a configured logic operation if necessary. The configured logic operation is first re-executed and the result set on the output when at least one input state of the logic operation is changed or updated after reactivation.

Setting forced position function as supplementary function (for switching / blind actuator 8/16 gang only available with ETS3.0d and higher).

The forced position function, according to the function diagram (figure 25), can also be combined with other functions of the output. With an active forced position the upstream functions are overridden so that the output concerned is locked in the forced position.

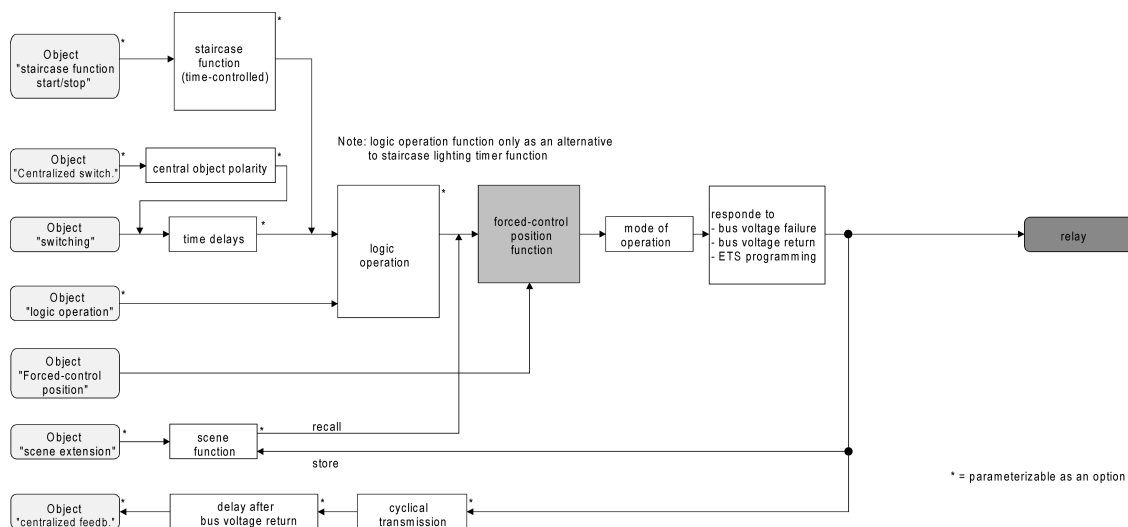

Figure 25: Function diagram of the forced position function

- On the parameter page "Ax - supplementary functions", set the parameter "selection of supplementary function" to "forced position".

The forced position function is enabled. The communication object "forced position" and the parameter of the forced position function become visible.

With the 2 bit forced position the switching state of the output is determined directly by the forced position telegram. The first bit (bit 0) of the "Forced position" object specifies the switching state to be forced. The second bit (bit 1) of the object activates or deactivates the forced-position state (see table 1).

- i** The configured "Behaviour after bus voltage return" of the forced position is only executed if the last ETS programming of the application or parameters ended at least approx. 20 s prior to switching on the bus voltage. Otherwise ($T_{ETS} < 20$ s), the forced position will not be activated and the "Behaviour after ETS programming" will be adopted in the event of bus voltage return.

Setting logic operation function as supplementary function

A logic function can be parameterized separately and independently for each output. This function allows the logic operation of the "switching" object state and an additional logic operation object. The state of the communication object for "switching" can also be evaluated with a time delay if a switch-on delay or switch-off delay is set.

The logic operation function, according to the function diagram (figure 26), can also be combined with other functions of the output. A combination with the staircase function or cyclic monitoring is not possible, however.

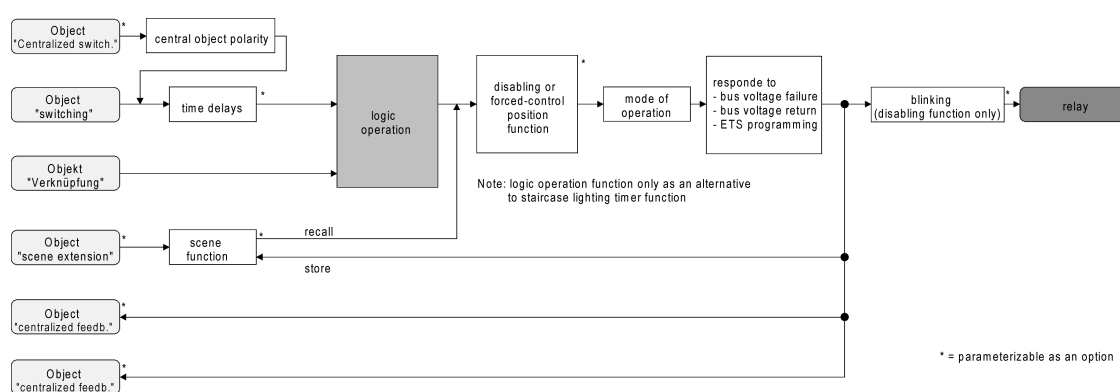

Figure 26: Function diagram of the logic operation function

The following logic operation types are configurable (figure 27).

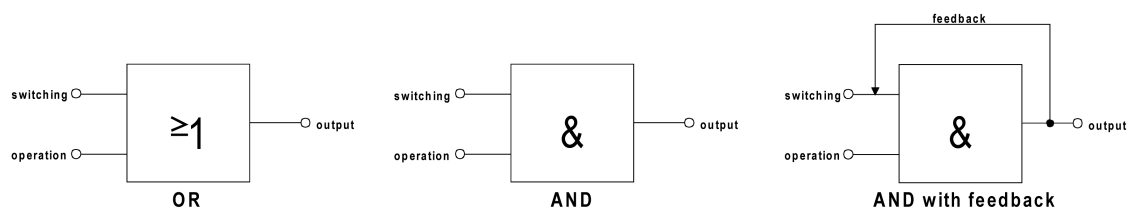

Figure 27: Logic operation types of the logic operation function

- i** "AND with feedback":
With a logic object = "0", the output is always "0" (logic AND). In this case, the feedback signal from the output to the "switching" input will directly reset this input when it is being set. The output can assume the logical state "1" by a newly received "1" on the input "switching" only when the logic object is = "1".

The object "logic operation" can be installed with a preconfigured value after bus voltage return or after programming with ETS so that a correct logic operation result can be determined immediately and set on the output during a telegram update on the "switching" object.

- On the parameter page "Ax - supplementary functions", set the parameter "Logic operation function" to "Yes". auf "Ja" einstellen.

The logic operation function is enabled. The communication object "logic operation" and the parameters of the logic operation function become visible.

- On the parameter page "Ax - supplementary functions", set the parameter "Type of logic operation function" to the desired logic operation type.
- On the parameter page "Ax - supplementary functions", set the parameters "object value of the logic operation object after bus voltage return" and "object value of the logic operation object after ETS download" to the required initial states.

The "logic operation" object is initialised immediately with the set switching states after bus voltage return or ETS programming of the application program or parameters.

- i** The logic operation function after a reset of the actuator (bus voltage return or programming with the ETS) is first executed when at least one input object of the logic operation is updated by a telegram from the bus.
- i** The states or switching states specified at the end of a disabling function or forced position function, which are set after programming in the ETS, in the case of bus voltage failure or after bus or mains voltage return, override the logic operation function. The configured logic operation is first re-executed and the result set on the output when at least one input state of the logic operation is changed or updated.
- i** A mains voltage return does not influence the communication of the logic operations. The objects remain on the last set state if the bus voltage was connected interruption free.

4.2.4.2.2 Functional description of the venetian blind outputs

Operating mode

Each output of the switching / blind actuator can be independently configured for the drive type connected by defining the mode of operation. The device permits controlling slatted Venetian blinds, roller shutters, awnings and also venting louvres. Depending on the preset operating mode, the ETS adapts the parameters and communication objects for all functions of an output. For example, in the "Venetian blind" operation mode, there are also parameters and objects for slat control. There is no slat control in the "Roller shutter / awning" operating mode, but a fabric stretching function can be configured for awning use. In the "Venting louver" operation mode, a distinction is made between the "Closing" and "Opening" drive movements, instead of an up or down movement for Venetian blinds or roller shutters.

In this documentation, Venetian blinds, roller shutters or awnings are also designated with the term "blind", if the text does not explicitly refer to a particular function (e.g. slat control).

In all modes it is possible to specify positions.

Presetting the mode of operation

The parameter "Mode of operation" exists separately for each shutter output on the parameter page "Ax General" (x = number pair of output).

- Select the required operating mode in the "Operating mode" parameter.
- i** The "Operating mode" parameter has an influence on many channel-oriented parameters and communication objects of the venetian blind outputs. When the operating mode is changed in the ETS, the parameters are adapted dynamically so that settings already made or links between group addresses can be reset. For this reason, the required operating mode should be configured at the beginning of the channel-oriented device configuration.
- i** Venting louvres must be connected to the outputs in such a way that they are opened in the movement direction "up - ▲" and closed in the movement direction "down - ▼".
- i** An awning travels upwards when it is rolled up.

Behaviour in case of bus voltage failure, after bus or mains voltage return or after programming with the ETS

The preferred relay contact positions in case of bus voltage failure, bus or mains voltage return or after ETS programming can be preset separately for each output. Since the actuator is equipped with mains-dependent monostable relays, the relay switching state at bus voltage failure can be defined as well.

Presetting the behaviour after ETS programming

The parameter "Behaviour after ETS programming" can be preset separately for each output channel on the parameter page "Ax - General" (x = number pair of output). This parameter can be used to configure the relay behaviour of the output irrespective of the behaviour after a bus or mains voltage return.

Depending on the selected operating mode, the ETS adapts the designations of the parameter settings ("raising" ↔ "opening the louver" / "lowering" ↔ "closing the louver").

- Set the parameter to "stop".
After programming with the ETS, the actuator switches the relays of the output to the "stop" position. A drive movement, if any, will be interrupted.
- Set the parameter to "raising" or "opening the louver".
After programming with the ETS, the actuator raises the blind or opens the venting louver.
- Set the parameter to "lowering" or "closing the louver".
After programming with the ETS, the actuator lowers the blind or closes the venting louver.

- i** At the beginning of each ETS programming cycle, the switching / blind actuator always executes a "stop" command for all venetian blind outputs. The manual mode, if active, will be terminated.
- i** The "Behaviour after ETS programming" as configured will be executed after every ETS application or parameter download. A simple download of the physical address alone or partial programming of only the group addresses has the effect that this parameter is disregarded and that the configured "Behaviour after bus or mains voltage return" will be executed instead.
- i** Programming with the ETS is possible when the bus voltage line is connected to the switching / blind actuator and the bus voltage supply is on. The mains voltage supply is not required for an ETS download. If programming with the ETS was performed with bus voltage only, the parameterized "Behaviour after ETS programming" will only be executed when also the mains voltage supply of the actuator has been switched on. "Behaviour after bus or mains voltage return" is not activated!
This response should be noted especially for actuators that are installed in an electrical installation in a preprogrammed state.
- i** After programming with the ETS, the safety functions, the forced positions (for switching / blind actuator 8/16 gang only available with ETS3.0d and higher) and the sun protection function are always deactivated.

Presetting the behaviour in case of bus voltage failure

The parameter "Behaviour in case of bus voltage failure" can be preset separately for each output channel under "Ax General"(x = number pair of output). The parameter defines the behaviour of a shutter output if only the bus voltage fails. The parameterized behaviour will not be adopted, if a manual control mode is active at the time of bus failure (state LEDs blinking in case of temporary or permanent manual control).

Depending on the selected operating mode, the ETS adapts the designations of the parameter settings ("raising" ↔ "opening the louver" / "lowering" ↔ "closing the louver").

- Set the parameter to "stop".
In case of bus voltage failure, the actuator switches the relays of the output to the "stop" position. A drive movement, if any, will be interrupted.
- Set the parameter to "raising" or "opening the louver".
After bus voltage failure, the actuator raises the blind or opens the venting louver.
- Set the parameter to "lowering" or "closing the louver".
After bus voltage failure, the actuator lowers the blind or closes the venting louver.
- Set the parameter to "position approach".
In case of bus voltage failure, the connected drive can approach a position specified by further parameters (0...100 %). If Venetian blinds are controlled with the device, the slats can be positioned independently. The actuator performs a reference travel before the position approach, if the current position at the time of bus failure is unknown (e.g. due to power supply failure or to previous ETS programming).
- Set the parameter to "no reaction".
In the event of bus voltage failure, the relay of the output shows no reaction. Motions still in progress at the time of failure will still be completed as long as the mains voltage supply is still on.
- i** Safety, forced position or sun protection functions (independent of the selected priority) remain active even after a bus voltage failure as long as the mains voltage supply is still on. These functions will therefore be executed again at the end of a temporary or permanent manual control (if enabled in case of bus failure) even if there is no bus voltage.
- i** When the still ongoing motion or the motion parameterized in case of bus voltage failure has come to an end, the outputs can no longer be activated except by manual control (if the mains voltage is on and if manual control is enabled) or by bus/mains voltage return.

- i** A bus voltage failure will in any case result in a stop of all time functions. Thus, all scene recalls in the delay phase will be aborted and all delay times for sun protection and presence will be ended by ignoring the object value last received and still in the delay phase. A telegram update received shortly before bus voltage failure is then lost, if the corresponding delay has not yet elapsed.
- i** In the event of a mains voltage failure, all relays of the actuator will always drop out ("stop") independent of the bus voltage condition. In this state the outputs can no longer be activated. Time functions (scene, sun protection and presence delays) are not interrupted, if only the mains voltage fails.
- i** When there is a bus or mains voltage failure, the current position data is permanently saved internally, so that these position values can be accurately repositioned after bus or mains voltage return, should this be configured. The data are stored before the reaction parameterized for the case of bus voltage failure takes place and only if one part of the supply (mains or bus) is still present, or if the supply fails completely after the mains voltage has been available before without interruption for at least 20 seconds after the last reset (storage capacitors sufficiently charged for storage purposes). The data will not be stored, if the position data is unknown. The saving process is performed only once after the failure of one part of the supply voltage...

Example 1:

Bus voltage failure -> Data storage -> Then mains voltage failure -> No further data storage,

Example 2:

Mains voltage failure -> Data storage -> Then bus voltage failure -> No further data storage.

The following rules apply for the position data to be stored:

The current blind, slat and louver positions are stored. With Venetian blinds, the height to be stored is always referred to a slat position of 100 % (cf. "Calculating the slat position"). Positions temporarily approached will be stored also for those outputs that are involved in a travel movement at the time of data storage. On account of the fact that position data is stored as integer percentage values (0..100), a minor deviation from the positions reported back later upon bus or mains voltage return (number range 0..255) cannot be avoided.

Because the position data are saved only once in the event of bus voltage failure, positions that are changed after a bus voltage failure, for example via manual control, are not tracked! Similarly, forced position telegrams received via the bus after a mains voltage failure or slat offset positions for the sun protection function cannot be stored and tracked either. Stored position data are not lost during programming with the ETS.

In case of ETS programming, the saved position data is not lost.

- i** In case of bus or mains voltage failure, the current states of the forced positions (for switching / blind actuator 8/16 gang only available with ETS3.0d and higher) or – if parameterised – the slat offsets of the sun protection positions are stored as well.

Behaviour after bus or mains voltage return presetting

The parameter "Behaviour after bus or mains voltage return" can be preset separately for each output channel on the parameter page "Ax General" (x = number pair of output).

Depending on the selected operating mode, the ETS adapts the designations of the parameter settings ("raising" ↔ "opening the louver" / "lowering" ↔ "closing the louver").

- Set the parameter to "stop".
In case of bus or mains voltage return, the actuator switches the relays of the output to the "stop" position. A drive movement, if any, will be interrupted.
- Set the parameter to "raising" or "opening the louver".
After bus or mains voltage return, the actuator raises the curtain or opens the venting louver.

- Set the parameter to "lowering" or "closing the louver".
After bus or mains voltage return, the actuator lowers the curtain or closes the venting louver.
- Set the parameter to "position during bus / mains failure".
After bus or mains voltage return, the position values (incl. slat position with blinds) last set and internally stored before bus or mains voltage failure will be tracked. The actuator performs a reference travel before the position approach, if the current position at the time of bus or mains voltage return is unknown (e.g. due to complete power supply failure or to previous ETS programming).
- Set the parameter to "position approach".
After bus or mains voltage return, the connected drive can travel to a position (0...100 %) specified by other parameters. If Venetian blinds are controlled with the device, the slats can be positioned independently. The switching / blind actuator performs a reference travel before the position approach, if the current position at the time of bus or mains voltage return is unknown (e.g. due to complete power supply failure or to previous ETS programming).
- Set the parameter to "no reaction".
In the event of bus or mains voltage return, the relay of the output shows no reaction. Any movements still in progress at the instant when voltage returns will still be completely finished.
- ⓘ "Position during bus / mains failure" setting: If no position values could be stored in case of bus or mains voltage failure because the position data were unknown (no reference travel executed), the actuator shows no reaction with this parameterization either.
- ⓘ "No reaction" setting: The commands received via the bus during a mains voltage failure (bus voltage present) are tracked when the mains voltage returns. Interrupted short- or long-time travel movements - if not completed - are restarted at full length and position approaches are continued from the break point.
- ⓘ All time functions (scene, sun and presence delay) are only stopped in case of bus voltage failure so that a mains voltage failure does not result in a loss of states or time functions as long as the bus voltage is present.
- ⓘ The parameterized behaviour is always executed independent of the current states of the safety or sun protection function. Safety and sun protection function can nonetheless be active even after bus or mains voltage return, if these functions have been activated before a bus voltage failure or before or during a mains voltage failure. Any direct operation can thus be overridden.
Only in the case of complete failure of the supply voltage (bus and mains voltage) are the sun protection or the safety functions deactivated.
- ⓘ The communication object of the forced position (for switching / blind actuator 8/16 gang only available with ETS3.0d and higher) can be initialised separately after bus voltage return. This has an effect on the reaction of the output when the forced position is activated. A mains failure alone has no effect on the forced position. If only the mains voltage return, a previously activated forced position remains active.
The configured "behaviour in the case of bus or mains voltage return" will only be executed if no forced position on bus voltage return is activated!
- ⓘ After return of bus voltage a manual control will be interrupted.. In case of mains failure, no manual control is possible.
- ⓘ The device only executes the configured "Behaviour during bus or mains voltage return" only if the last ETS programming of the application or of the parameters ended at least approx. 20 s prior to switching on the bus and mains voltage. Otherwise ($T_{ETS} < 20$ s), the "Behaviour after ETS programming" will be adopted also in case of bus/mains voltage return.
If just the bus or mains voltage fails after an ETS download and is then restored, the actuator executes the "Behaviour after bus or mains voltage return".

Determining and configuring short-time and long-time operation

The short-time operation (Step) permits adjusting the slat tilting angle of a blind or the 'slit opening width' of a shutter. In most cases, short-time operation is activated by pressing a Venetian blind pushbutton sensor permitting manual intervention in the blind controller. When the actuator receives a short-time command while the blind, shutter, awning or louver is in motion, the travel movement is stopped immediately by the switching / blind actuator. The long-time operation (Move) is determined by the movement time of the connected Venetian blind, roller shutter/awning or louver and must therefore not be preset separately. The movement time must be measured 'manually' and entered into the ETS parameters. The control of an output by means of a long-time or a short-time telegram is also designated as 'direct operation'.

To ensure that the curtain or the venting louver has definitely reached its end position at the end of long-time operation, the switching / blind actuator always prolongs the long-time movement by 20% of the parameterized or learnt travelling time.

The parameterized travelling time extension will moreover be taken into account by the actuator for all upward travels or all travel movements into the open position as the drive motors are then generally not so fast due to the weight of the curtains or to external physical influences (e.g. temperature, wind, etc.). Thus, it is ensured that the upper end position is always reached even in case of uninterrupted long time travel movements.

- i** A long time or a short time operation can be retrIGGERED by a new incoming long time or short time telegram.
- i** A travel movement activated in the manual control mode or by a safety function is always a long-time operation. The "raising" or "lowering" commands configured in the ETS will equally activate the long time operation.

Presetting the STEP operation

The STEP operation is parameterized separately for each output and independent of the travelling time of the curtain or of the louver. The project designer can specify in the ETS whether the output executes only a "stop" for a travel movement on reception of a STEP telegram or whether the output is activated for a specific duration.

- Set the parameter "STEP operation" on parameter page "Ax - Times" (x = number pair of the output) to "Yes".
The actuator activates the output concerned for the time specified under "Time for STEP operation" when a STEP telegram is received and when the output is not in the process of executing a travel movement. If the output is executing a travel movement at the time of telegram reception, the output will just stop.
 - Set the parameter "STEP operation" on parameter page "Ax - Times" (x = number pair of the output) to "No (only stop)".
The actuator will only stop the output on reception of a STEP telegram if the output is in the process of executing a travel movement. There will be no reaction if the output is not executing a travel movement at the time of telegram reception.
- i** The parameterized "Time for STEP operation" should correspond for a blind to ca. $\frac{1}{4}$ of the complete slat moving time and for a shutter to the full time needed for opening the shutter segments.
 - i** The STEP operation is always executed without travelling time extension.

Determining and configuring travelling times

For computing positions and also for executing long-time operation, the switching / blind actuator needs the exact travelling time of the connected blind, venetian blind, awning or venting louver. The movement time must be measured 'manually' and entered into the ETS configuration for an output. It is important to determine the movement time accurately to permit positions to be approached with good precision. Therefore, it is recommended to make several time measurements and to take the average of these values before entering them into the corresponding parameter.

The movement time corresponds to the duration of a drive movement from the completely open position (upper end position / awning rolled up) to the completely closed position (lower end position / awning completely unrolled). Not vice-versa! The travelling times are to be determined as a function of the different types of movements (figure 28).

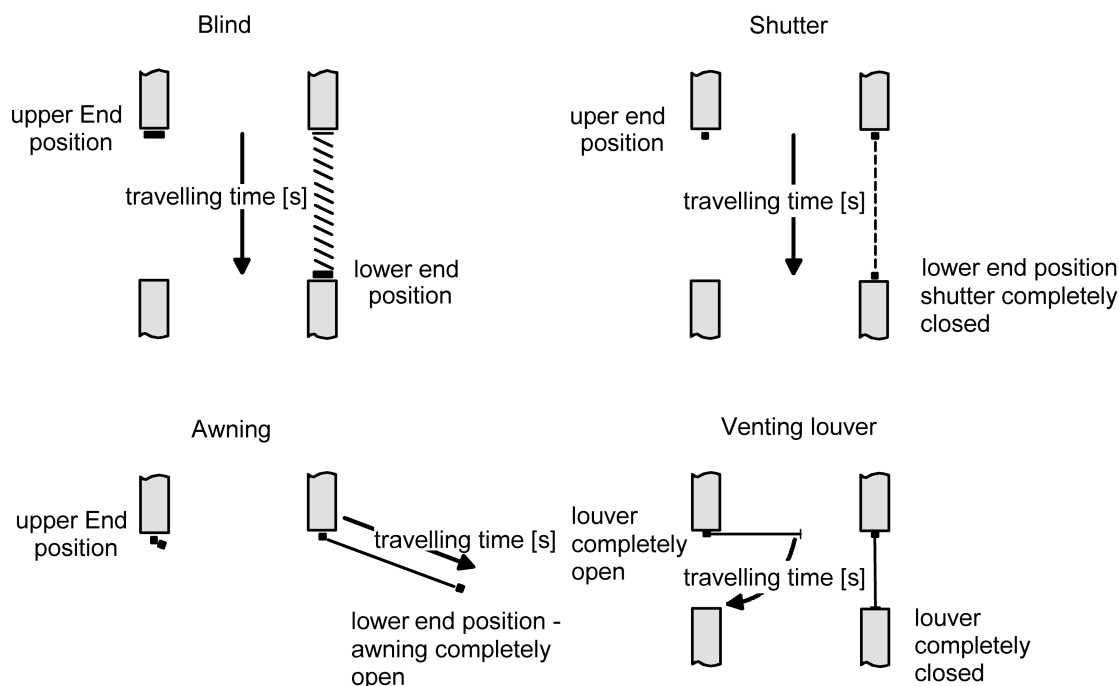

Figure 28: Determining the movement time according to the drive type

Setting the movement time of Venetian blinds, roller shutters/awnings and louvers

The measurement of the movement time is described in detail in chapter "Commissioning".

- Enter the exact travelling times determined in the course of the commissioning procedure into the parameters "Blind travelling time" or "Shutter/awning travelling time" or "Venting louver travelling time" on parameter page "Ax – Time settings" (x = number pair of output). The maximum travelling time is '59 minutes 59 seconds'. The working principle does not allow longer movement times.
- i** The parameterized travelling time extension will moreover be taken into account by the actuator for all upward travels or all travel movements into the open position as the drive motors are then generally no so fast due to the weight of the curtains or to external physical influences (e.g. temperature, wind, etc.).

Determining and configuring the slat moving time (only with slatted blinds)

If Venetian blinds are controlled, the slats can be positioned independently. To enable the switching / blind actuator to compute slat positions and to report them back to the bus, it is necessary that the actuator gets precise information about the time required for a slat rotation. The slat moving time must in each case be determined and configured 'manually'.

The switching / blind actuator is designed in such a way that it can control single-motor venetian blind drives without a working position. In this drive mode, the slats are directly adjusted by way of mechanical linkage when the height of the Venetian blind is changed. The actuator assumes that the slats are completely closed when the blind moves downwards. The actuator assumes that the slats are completely closed when the Venetian blind moves downwards (figure 29). These Venetian blinds are the most common type on the market.

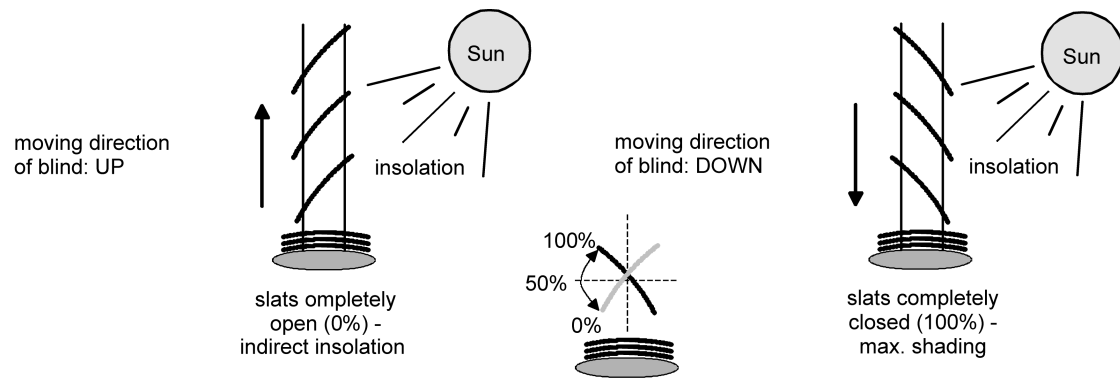

Figure 29: Type 1 - Slatted Venetian blinds with oblique slat position in both travel directions

There are also single-motor Venetian blind systems without a working position the slats of which are horizontal during an upward travel and oblique during a downward travel. Such blind types can also be connected to the switching / blind actuator in which case a completely open slat position corresponds to the slats in horizontal position (figure 30).

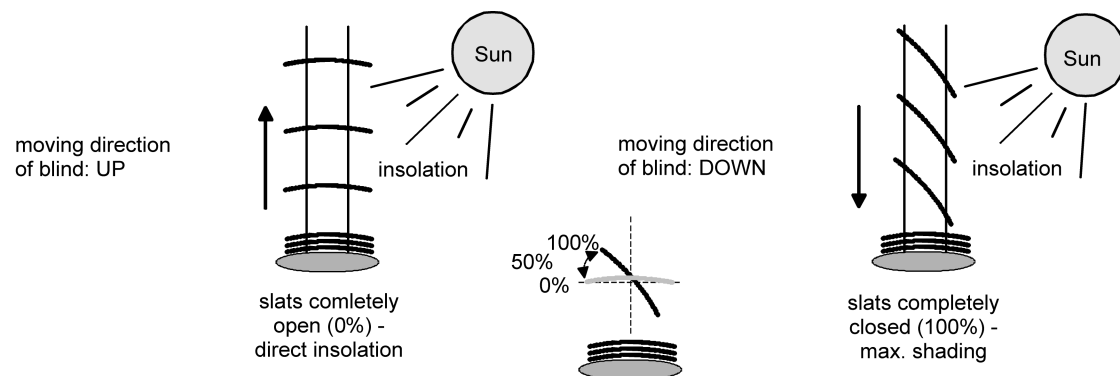

Figure 30: Type 2 - Slatted Venetian blinds with oblique and horizontal slat position

Presetting the slat moving time

The measurement of the slat moving time is described in detail in chapter "Commissioning".

- Set the parameter "Slat moving time" on parameter page "Ax – Times" (x = number pair of output) exactly to the value determined in the course of the commissioning procedure.

- i** The slat moving time must be shorter than the preset or learnt blind travelling time.
- i** The configured movement time extension will also be taken into account when slats are moved into the completely open position (upward movement).

Determining and configuring the travelling time extension and the change-over time

When travelling upwards, blinds, shutters or awnings have a tendency of moving more slowly due to their own weight or to external physical influences (e.g. temperature, wind, etc.). The same applies to venting louvers where opening may take longer than closing.

For this reason, the switching / blind actuator takes the parameterized travelling time extension into account when moving upwards or when opening louvers. The extension is computed as a percentage of the difference of the movement times in both directions.

The movement time extension should be determined separately for each output during commissioning and entered into the ETS configuration.

The measurement of the movement time extension is described in detail in chapter "Commissioning".

Example for determining the movement time extension:

- "Movement time" previously determined and configured: $T_{OU} = 20$ seconds,
- Time determined for movement from lower to upper end position: $T_{UO} = 22$ seconds,
- Calculated supplementary movement time: $T_{UO} - T_{OU} = 2$ seconds -> 2 seconds out of 20 seconds are 10 %,
- Movement time extension to be configured: 10 %.

To protect the drive motors from irreparable damage, a fixed pause during movement direction switch-over can be configured for each output. During the pause, no movement direction is active ("stop"). The necessary parameter value can normally be found in the technical documents of the drive motor used. The change-over time is accounted for in every state of operation of the actuator.

Presetting the movement time extension

- Enter the determined travelling time extension (by rounding up the determined extension value) into the parameter "Travelling time extension for upward travel" on parameter page "Ax – General" (x = number pair of output).

Presetting the switchover time for movement direction changes

- Set the parameter "Change-over time for travel direction changes" on parameter page "Ax Time Settings" (x = number pair of output) to the required change-over interval.

i When the switching / blind actuator is delivered ex factory, the change-over time is generally preset to 1 s.

Computing the curtain height or the louver position

The switching / blind actuator has a comfortable and accurate positioning function. The actuator calculates the current position of the connected blind, shutter, awning or louver whenever these elements are adjusted either by manual or bus control. The calculated position value is a measure of the height of the blind or of the opening width of the venting louver (figure 31).

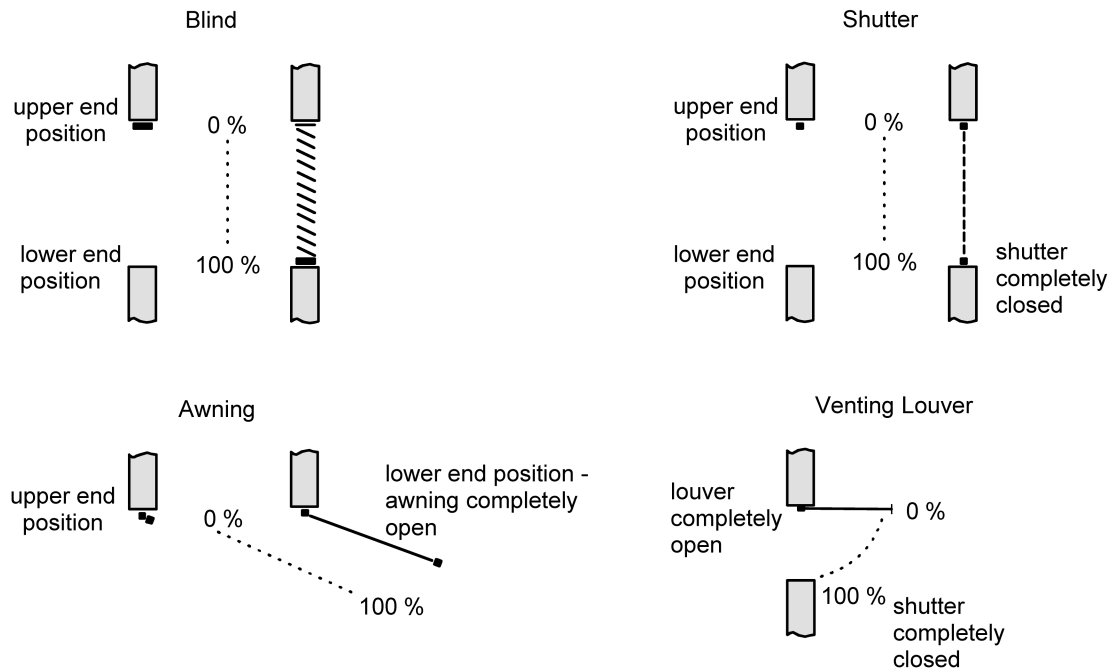

Figure 31: Positions defined as a function of the type of movement

The switching / blind actuator derives the positions from the configured travelling time since conventional drives do not provide feedback about their positions. Thus, the travelling time separately parameterized for each output is the reference for all position approaches and of basic importance for the accuracy of the position calculations. For this reason, the travelling times should be determined with great accuracy in order to achieve the best possible positioning results.

For positioning purposes, the actuator calculates the movement time required as a function of the current position.

Example 1...

The roller shutter connected to the certain output has an overall travelling time of 20 s. The roller shutter is in its upper end position (0 %). It is to be positioned at 25 %. The actuator calculates the movement time required for approaching the desired position:
 $20 \text{ s} \times 0.25_{(25 \%)} = 5 \text{ s}$. The output will then lower the roller shutter for 5 s and thus position the blind at height of 25 %.

Example 2...

The roller shutter connected to the certain output has an overall travelling time of 20 s. The shutter is in the 25 % position. It is to be positioned at 75 %. The difference between the positions is 50 %. The actuator calculates the travelling time required for bridging the difference between the positions: $20 \text{ s} \times 0.5_{(50 \%)} = 10 \text{ s}$. The output will then lower the roller shutter for 10 s and thus position the blind at height of 75 %.

With all the upward movements, the configured movement time extension is automatically added to the calculated movement time.

Example 3...

The shutter connected to the certain output has an overall travelling time of 20 s. The shutter is in the 75 % position. It is to be positioned at 25 %. The difference between the positions is 50 %. The actuator calculates the unextended movement time required for bridging the difference between the positions:
 $20 \text{ s} \times 0.5_{(50 \%)} = 10 \text{ s}$. Taking the movement time extension into account (e.g. 10 %), the actual raising time is: $10 \text{ s} \times ((100 \% + 10 \%_{(\text{extension})}) : 100 \%) = 10 \text{ s} \times 1.1 = 11 \text{ s}$. The output will then raise the roller shutter for 11 s and thus position it at a blind height of 25 %.

When the lower or upper end positions (0 % or 100 %) are approached, the movement time is always 20 % longer than the overall movement time.

Example 4...

The shutter connected to the certain output has an overall travelling time of 20 s. The shutter is in the 75 % position It is to be positioned at 100 %. The difference between the positions is 50 %. The actuator calculates the movement time required for bridging the difference between the positions: $20 \text{ s} \times 0.5_{(50 \%)} = 10 \text{ s}$. As the movement is a limit position movement, the actuator adds 20 % of the total movement time:

$10 \text{ s} + (20 \% : 100 \%) \cdot 20 \text{ s} = 14 \text{ s}$. The output will then lower the roller shutter for 14 s and thus positions it safely at a blind height of 100 %.

Example 5:

The shutter connected to the certain output has an overall travelling time of 20 s. The shutter is in the 75 % position It is to be positioned at 0 %. The difference between the positions is 50 %.

The actuator calculates the unextended movement time required for bridging the difference between the positions: $20 \text{ s} \times 0.5_{(50 \%)} = 10 \text{ s}$. As the movement is a limit position movement, the actuator also adds 20 % of the total movement time: $10 \text{ s} + (20 \% : 100 \%) - 20 \text{ s} = 14 \text{ s}$.

Taking the movement time extension into account (e.g. 10 %), the actual raising time is: $10 \text{ s} \times ((100 \% + 10 \%_{(extension)}) : 100 \%) = 10 \text{ s} \times 1.1 = 15.4 \text{ s}$. The output will then raise the roller shutter for 15.4 s and thus position safely at 0 %.

- i** The switching / blind actuator executes position approaches only if a new position deviating from the current position is preset.
- i** The switching / blind actuator stores the blind/shutter/awning or louver positions temporarily. The shutter actuator can approach newly preset blind/shutter/awning or louver positions only if the current positions are known. For this purpose, each output must be given the opportunity to synchronise itself whenever the supply voltage is switched on or after every ETS programming operation (physical address, application program, partial download). Synchronisation is performed with the help of a reference movement (cf. "reference movement").
- i** Position approaches in progress will be aborted in case of bus or mains voltage failure. In case of bus voltage failure, the configured behaviour will be executed. In case of mains failure, the drives will be stopped. Position approaches are also interrupted when the manual control mode is activated.

Calculating the slat position (only with blinds)

In the "blinds" operating mode, the switching / blind actuator always calculates the slat position so that the opening angle and thus the 'amount of light admitted' into the room by the blind can be adjusted. A new position approach by a Venetian blind will always be followed by a positioning movement of the slats. Thus, the slat positions last selected will be tracked or readjusted to a new value if a position change has taken place.

In case of single-motor Venetian blind systems without a working position, the slats will be readjusted directly by a change of the Venetian blind height. For this reason, an adjustment of the slat position will always have an influence on the position of the Venetian blind itself (figure 32).

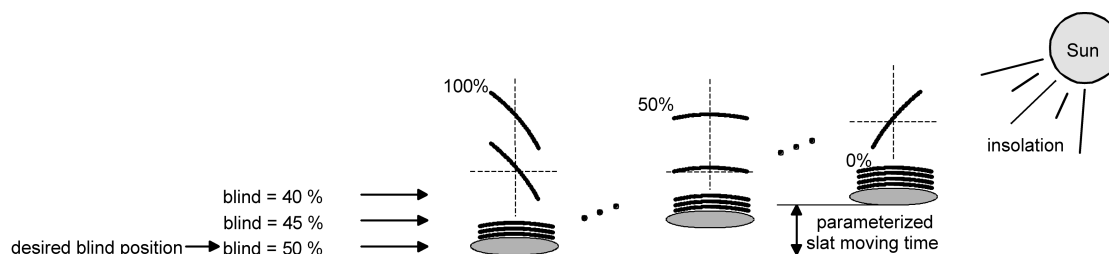

Figure 32: Example of slat positioning affecting the position of the Venetian blind (typical of slat type 1; analogous reaction for type 2)

Since a preset slat position is to remain constant until the next change, the actuator will not change the height of the Venetian blind, if the calculated movement time required for a change of position lies within the configured slat moving time.

Similarly, the actuator accounts for the ratio of the moving times of slat and Venetian blind and – in case of slat position changes – always recalculates the resulting Venetian blind position. If the position feedback objects are used (cf. "Position feedback"), the actuator transmits the blind positions changed by the adaptation also to the bus.

Example (figure 32)...

The Venetian blind position is preset to 50 %. A change of the slat angle (100 %...0 %) initiates the calculation of a new Venetian blind position which is also tracked in the position feedback objects. If the actuator is to approach a new blind position of, let's say 47 % in this case, the actuator will not perform a travel movement as the calculated travelling time lies within the parameterized slat moving time and therefore coincides with the slat movement. A change of the Venetian blind position to 55 % in this case triggers a Venetian blind movement as the change does not lie within the slat movement (0 to 100 %).

In each position operation, the Venetian blind setpoint position refers to a slat position of 100 %. In the event of a slat repositioning movement (0 to 100 %), the system will therefore report a Venetian blind position below the desired position.

Exception: The Venetian blind setpoint position of 0 % (upper end position) is assigned to the slat position of 0 %. The readjustment of the slat position will result also in this case in a change of the Venetian blind height (brief downward movement). Only in this case will the actuator report back a Venetian blind position above the Venetian blind setpoint position (figure 33). With slat type 1, the slats are generally horizontal when the Venetian blind is in its upper end position. For this reason, the calculated slat position with a slat type 1 corresponds to the actual opening angle only after the first slat is completely extended (100%).

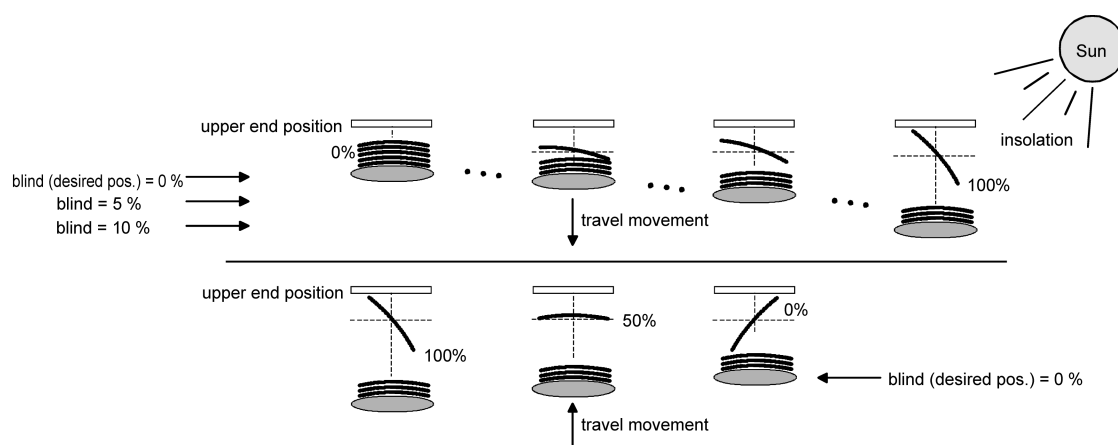

Figure 33: Example of slat positioning with the Venetian blind in upper end position (typical of slat type 1)

Example (figure 33)...

The Venetian blind position is preset to 0 %. After an extended movement, the Venetian blind is safely in the upper end position. A change of the slat angle (0 %...100 %) initiates the calculation of a new Venetian blind position which is also tracked in the position feedback objects. If the actuator is to approach a new blind position of, let's say 5 % in this case, the actuator will not perform a travel movement as the calculated travelling time lies within the parameterized slat moving time and therefore coincides with the slat movement. A change of the Venetian blind position to 15 % in this case triggers a Venetian blind movement as the change does not lie within the slat movement (0 to 100 %).

- i** The switching / blind actuator executes slat position adjustments only if a new position deviating from the current slat position is preset.

- i** The switching / blind actuator stores the slat positions temporarily. The actuator can approach newly preset slat positions only if the current position is known. For this purpose, each output must be given the opportunity to synchronise itself whenever the supply voltage is switched on or after every ETS programming operation (physical address, application program, partial download). The synchronisation is performed with the help of a reference movement for the slat or the Venetian blind (cf. "reference movement").
- i** A change of the Venetian blind height will always result in a change of the slat position. After reactivation of the supply voltage or after ETS programming, the actuator will in this case generally move the slats into the 100 % position, if no position has been preset for the slats.
- i** The smaller the ratio between slat moving time and Venetian blind travelling time, the more precise the position approaches and the less marked the influence of the slat angle adjustment on the height of the Venetian blind.

Reference movement

After ETS programming (physical address, application program, partial download) or after actuator supply voltage failure (bus and mains voltage) all current position data are unknown. Before the actuator can approach new positions after bus and mains voltage return or after programming, the positioning system must at first be calibrated. A position calibration is possible by executing the reference movement.

A reference movement is the time required for a travel movement into the upper end position increased by 20 % and additionally by the configured travel time extension (figure 34). A reference travel is not retriggerable.

Reference movements can be executed by the following commands...

- Uninterrupted long time operation (including also a terminated safety movement) into the upper end position activated via the corresponding communication object,
- an approach of the 0 % position,
- a manually controlled movement into the upper end position.

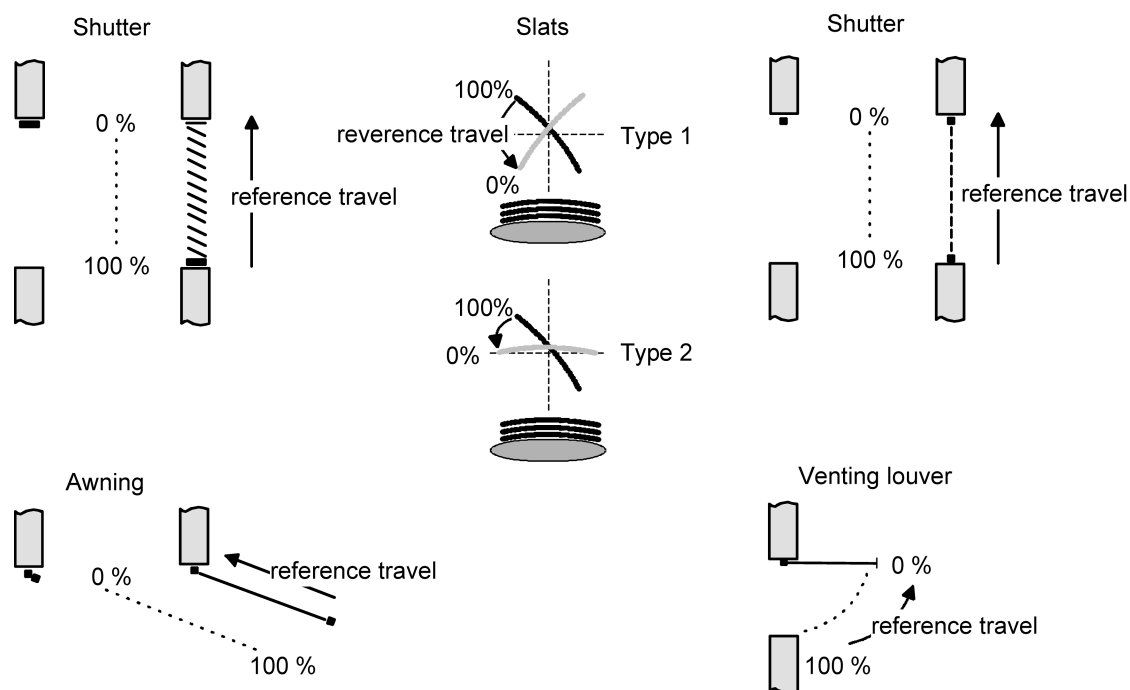

Figure 34: Reference movement

In the event of slat positioning via the corresponding communication objects after bus and mains voltage return or after programming, a slat reference movement becomes necessary if the blind has not been moved beforehand in the up or down directions for at least the parameterized slat moving time. During a slat reference movement, the actuator always moves the slats for the parameterised slat moving time into the completely open position (0 %) and then to the desired position. The slat position is also considered as calibrated when the Venetian blind has been moved by a long-time command in the up or down direction during at least the configured slat moving time.

- i** A terminated reference movement of the Venetian blind will also calibrate the slat position.
- i** If the reference movement is interrupted for instance by a short-time operation, the position is still unknown as before.
- i** A long-time travel into the lower end position activated via the corresponding communication object also calibrates the reference position.
- i** With the sun protection function it is moreover possible to force the actuator to perform a reference movement before each sun protection travel even if the positions are known. Thus, it is ensured that in case of sun protection the configured sun protection position is always precisely approached even after repeated position approaches.
- i** Using the connected drives frequently for position approaches (for instance several times a day) can result after some time in positioning inaccuracies. These deviations from the setpoint position are mostly due to external physical influences. To achieve accurate positioning in operation it is recommended to perform the reference movement at least once every day. This can be achieved for instance by a central raising command transmitted to the long-time object.

Presetting the position

The following ways of presetting positions can be distinguished...

- Direct positioning via the positioning objects (direct operation),
- Positioning by activating the sun protection function,
- Position through the behaviour after bus voltage failure or bus or mains voltage return,
- Positioning by a scene recall.

Positioning via the positioning objects:

Each Venetian blind, roller shutter, awning or venting louvre can be positioned directly using the "Position ..." object, which is separate for each output. An independent positioning object exists for each of the slats. The position approached is always the position last received. The actuator does not show a reaction when the set or to be approached position value is received several times in succession.

This type of control is termed 'direct operation' just like operation via short time, long time or central objects or a scene recall. Positioning via the objects therefore has the same priority. A position movement caused by the communication objects can be interrupted at any time by a long time command, short time command, central command or a scene recall. The direct operation can be overridden by a function with a higher priority, e.g. manual control, forced position, safety or also sun protection (configurable).

The position telegrams must conform to the 1-byte data format as per KNX datapoint type 5.001 (scaling). The switching / blind actuator converts the value received (0...255) linearly into a position (0...100 %) (see table 2).

Received value (0...255)	Position derived from value (0...100 %)
0	0 % (upper end position / slat or venting louvre opened)
↓	↓ (all intermediate values rounded off to 1 % increments)
255	100 % lower end position / slat or louvre closed)

Table 2: Data format of positioning objects with conversion into percentage position values

It is possible that new positioning telegrams are being received while a position approach is in progress. In this case, the actuator immediately reverses the direction of travel, if the new position to be approached lies in the opposite direction.

If a slat positioning command is received during a running Venetian blind position approach, the device finishes first the Venetian blind position approach before positioning the slat. If a blind positioning command is received during a slat positioning movement, the actuator interrupts the slat positioning movement and approaches the new blind position. Only then does the actuator switch to the most recently received slat position.

In case of Venetian blind positioning, slat positioning will always be executed later. After switching on the power supply of the actuator or after programming with the ETS, it may be the case that the slat position is unknown, if no long-time command for the upward or downward travel with a duration of at least the configured slat moving time has been received or no slat positioning has taken place (no slat reference movement). In this case, the slat is moved during a Venetian blind position approach into the completely closed position (100 %). The slat position is then considered as calibrated.

- i** Optionally, the sun protection function offers the possibility of receiving the instruction of the blind height, venting louvre or slat position to be adopted during sunshine via separate communication objects and to preset these values variably. This form of variable position preset in the sun protection function is identical to presetting the positions via communication objects in direct operation. The priority of the incoming telegrams in direct operation with the sun protection activated can be additionally configured in the ETS.

Position through the sun protection function, the behaviour after bus voltage failure or bus or mains voltage return,

With the named functions of the switching / blind actuator, the positions to be approached are configured directly in the ETS, depending on the operating mode set. The position values can be specified between 0 % and 100 % in 1 % increments.

With Venetian blinds, the height of the Venetian blind is positioned first in these cases. The configured slat position is adjusted only thereafter.

- i** Important notes for all positioning movements: Using the connected drives frequently for position approaches (for instance several times a day) can result after some time in positioning inaccuracies. These deviations from the setpoint position are mostly due to external physical influences. To achieve accurate positioning in operation it is recommended to perform the reference movement at least once every day. This can be achieved for instance by a central raising command transmitted to the long time object.

Position feedback messages

In addition to presetting positions via positioning objects, the switching / blind actuator can track the current positions values via separate feedback objects and also transmit them to the bus, if the bus voltage is on. Thus, the preset setpoint position can be distinguished from the true actual position of the drives activated.

The following feedback telegrams can be preset for each output depending on the parameterized mode of operation...

- Feedback (1 byte) of the Venetian blind, roller shutter, awning or venting louvre position,
- Feedback (1 byte) of the slat position (only with Venetian blinds).

The individual position feedback messages can be enabled in the ETS independent of one another and have communication objects of their own.

For each travel movement the actuator calculates the current position and tracks it in the position feedback objects. The positions are tracked and the feedback objects updated even when an output has been activated via short-time or long-time telegrams or by manual control on condition that the bus voltage is on.

The feedback objects are updated after the following events...

- At the end of a drive movement – including a slat positioning movement in a Venetian blind – when the drive stops and when the new position is reached,
- With a movement to an end position already at the time the end position is theoretically reached, i.e. before the 20 % extension and the movement time extension have elapsed.

The feedback objects are not updated, if the position last reported back has not changed after a movement (for instance, when the Venetian blind is repositioned, the unchanged slat position will not be reported back a second time).

The switching / blind actuator cannot calculate a feedback position, if the current position data after switch-on of the supply (bus voltage and mains voltage) or after ETS programming are still unknown. In these cases, the actuator must first perform a reference travel (cf. "Reference travel") so that the position can be calibrated. In case of unknown positions, the actuator automatically performs reference travels, if new positions are preset and if these positions are to be approached. As long as a position is unknown, the value of the feedback objects is "0".

Presetting position feedback for Venetian blind, roller shutter, awning or venting louver positions

The feedback functions can be enabled and programmed independently for each output. When feedback is enabled, the ETS adapts the parameter texts depending on the preset operating mode ("Venetian blind position feedback", "Roller shutter/awning position feedback" or "Venting louver position feedback"). The feedback can be used as an active message object or as a passive status object. As an active signalling object, the position feedback information is transmitted to the bus whenever a position value changes. As a passive status object, there is no telegram transmission after a change. In this case, the object value must be read out. The ETS automatically sets the object communication flags required for proper functioning. In case of an actively transmitting signalling object, the current position can be transmitted to the bus after bus voltage return, if the position value differs from the one last transmitted. When the position data are known, the feedback telegram can in this case be transmitted with a time delay to reduce the bus load, with the delay being preset globally for all outputs in common (cf. "Delay after bus voltage return").

The feedback functions of an output must be enabled on parameter page "Ax – Enabled functions" (x = number pair of output). Only then are the parameters for the feedback functions visible.

- Set the parameter "Blind position feedback", "Shutter/awning position feedback" or "Venting louver position feedback" on parameter page "Ax – Feedbacks" to "feedback object is active signalling object".

The feedback object is enabled. The position value is transmitted as soon as it changes. No value will be actively transmitted, if the position is unknown.

- Set the parameter "Venetian blind position feedback", "Roller shutter/awning position feedback" or "Rückmeldung Lüftungsklappenposition" on parameter page "Ax - Feedbacks" to "feedback object is passive status object".

The feedback object is enabled. The position value will be transmitted in response only if the feedback object is read out from by the bus. If the position is unknown, a value of "0" will be reported back after readout.

The feedback must be set as actively transmitting.

- If a time delay after bus voltage return should be necessary, the parameter "Time delay for feedback after bus voltage return" on parameter page "Ax – Feedbacks" must be set to "yes"

The position feedback will be transmitted with a delay after bus voltage return. After the end of the time delay, the position last adjusted statically will be transmitted to the bus. No feedback telegram is transmitted during a running delay, even if a position value changes during this delay.

Presetting the position feedback for slat positions (only with Venetian blinds)

The feedback functions for the slat positions can be enabled and programmed independently for each output. As with the position feedback of the Venetian blind height, the feedback can be used as an active message object or as a passive status object.

In case of an actively transmitting signalling object, the current slat position can be transmitted to the bus after bus voltage return, if the position value differs from the one last transmitted. When the position data are known, the feedback telegram can in this case be transmitted with a time delay to reduce the bus load, with the delay being preset globally for all outputs in common (cf. "Delay after bus voltage return").

The feedback functions of an output must be enabled on parameter page "Ax – Enabled functions" (x = number pair of output). Only then are the parameters for the slat position feedback functions visible.

- Set the parameter "Slat position feedback" on parameter page "Ax – Feedbacks" to "feedback object is active signalling object".

The feedback object is enabled. The position value is transmitted as soon as it changes. No value will be actively transmitted, if the position is unknown.

- Set the parameter "Slat position feedback" on parameter page "Ax – Feedbacks" to "feedback object is passive status object".

The feedback object is enabled. The position value will be transmitted in response only if the feedback object is read out from by the bus. If the position is unknown, a value of "0" will be reported back after readout.

The feedback must be set as actively transmitting.

- If a time delay after bus voltage return should be necessary, the parameter "Time delay for feedback after bus voltage return" on parameter page "Ax – Feedbacks" must be set to "yes".

The position feedback will be transmitted with a delay after bus voltage return. After the end of the time delay, the position last adjusted statically will be transmitted to the bus. During a running delay the affected feedback object is updated but no feedback is transmitted actively, even if a position value changes during this delay.

- ❶ Behaviour of the position feedback on voltage failure & return:

When bus voltage returns and the mains voltage supply of the actuator is on, the current position data is always written to the feedback objects. The positions are transmitted to the bus also in those cases where the feedback objects are actively transmitting objects and where the position data differ from the data last reported back, for instance, as a result of manual control. If the position data is unknown, the feedback objects are initialised with "0" and not transmitted to the bus.

Without mains voltage supply the connected drives are not activated, which means that position feedback never takes place, even if bus voltage returns. In case of mains voltage return, the parameterized behaviour will be executed. The feedback objects are then updated provided the bus voltage is on.

- ❶ In case of Venetian blind operation, any position change of the Venetian blind within the limits of the slat adjustment (0 to 100 %) does not launch a movement and therefore no change of the feedback position data either.

'Unknown position' feedback and travel movement

In addition to position data feedback, the switching / blind actuator can also report back enlarged 1-bit status information messages and transmit them actively to the bus, if the bus voltage is on.

The following status feedback messages can be separately preset for each output...

- Feedback of an invalid position,
- Drive movement feedback,

Feedback of an invalid position:

After switch-on of the supply voltage (bus and mains voltage failure) or after programming with the ETS, all position data of an output are unknown. In this case – when the bus voltage is on – the actuator can update the feedback object "Invalid position"(object value "1") which will then signal that the object values of the 1-byte position feedback objects are invalid.

An invalid position feedback will be only be reversed (object value "0") after the position data for the Venetian blind, roller shutter, awning or venting louver have been calibrated by means of a reference movement. The calibration of the slat position in a Venetian blind alone will not result in the reversal of an 'invalid position' status message.

As an option, the object value of the status feedback message can be actively transmitted to the bus in case of a value change.

Drive movement feedback:

The switching / blind actuator can report back via a separate 1-bit communication object per output whether the connected drive is moving, i.e. whether the output is supplying current for any of the travel directions. The feedback object has a value of "1" when current is flowing from the output to the drive. Likewise, a "0" is written into the object if the output concerned remains in a stop position. In this case, the operation by which the output was activated (short-time or long-time operation, positioning, manual control, etc.) is of no importance.

As an option, the object value of the status feedback message can be actively transmitted to the bus in case of a value change.

A mains voltage failure in the actuator always results in a "0" being written into the "Travel movement" feedback object. Moreover, the state of the feedback is only derived from the relay state of the actuator. This means that if a drive is blocked or already in its end position, the value reported back does not correspond to the actual state of the drive movement.

Setting feedback of an invalid position

The feedback of an invalid position can be enabled and programmed independently for each output. When feedback is enabled, the ETS adapts the parameter texts depending on the preset operating mode ("Invalid Venetian blind position feedback",

"Invalid roller shutter/awning position feedback" or "Invalid venting louver position feedback").

The feedback can be used as an active message object or as a passive status object. As an active signalling object, the status feedback information is transmitted to the bus whenever a position value changes. As a passive status object, there is no telegram transmission after a change. In this case, the object value must be read out. The ETS automatically sets the object communication flags required for proper functioning.

If the object is an actively transmitting signalling object, the feedback telegram can be transmitted after bus voltage return with a time delay to reduce the bus load, with the delay being preset globally for all outputs in common (cf. "Delay after bus voltage return").

The feedback functions of an output must be enabled on parameter page "Ax – Enabled functions" (x = number pair of output). Only then are the parameters for the feedback functions visible.

- Set the parameter "Invalid blind position feedback", "Invalid shutter/awning position feedback" or "Invalid venting louver position feedback" on parameter page "Ax – Feedbacks" to "feedback object is active signalling object"

The feedback object is enabled. A telegram is transmitted as soon as there is a change (e.g. after ETS programming, after switch-on of the supply voltage or after a reference movement).

- Set the parameter "Invalid blind position feedback", "Invalid shutter/awning position feedback" or "invalid venting louver position feedback" on parameter page "Ax – Feedbacks" to "feedback object is passive status object".

The feedback object is enabled. A telegram will be transmitted in response only if the feedback object is read out by the bus.

The feedback must be set as actively transmitting.

- If a time delay after bus voltage return should be necessary, the parameter "Time delay for feedback after bus voltage return" on parameter page "Ax – Feedbacks" must be set to "yes"

The feedback of an invalid position will be transmitted with a delay after bus voltage return. After the end of the time delay, the object value state last adjusted will be transmitted to the bus. No feedback telegram is transmitted during a running delay, even if a position value becomes known during this delay, for example through a reference movement.

- i** Automatic transmission after bus voltage return only takes place if there has been an internal change to the object state (for example through a reference run during manual operation).

Setting drive movement feedback

The feedback of a drive movement can be enabled and programmed independently for each output. The feedback can be used as an active message object or as a passive status object. As an active signalling object, the status feedback information is transmitted to the bus whenever a position value changes. As a passive status object, there is no telegram transmission after a change. In this case, the object value must be read out. The ETS automatically sets the object communication flags required for proper functioning. If the object is an actively transmitting signalling object, the feedback telegram can be transmitted after bus voltage return with a time delay to reduce the bus load, with the delay being preset globally for all outputs in common (cf. "Delay after bus voltage return").

The feedback functions of an output must be enabled on parameter page "Ax – Enabled functions" (x = number pair of output). Only then are the parameters for the feedback functions visible.

- Set the parameter "Travel movement feedback" on parameter page "Ax – Feedbacks" to "feedback object is active signalling object".

The feedback object is enabled. A telegram is transmitted when the connected drive starts moving or stops.

- Set the parameter "Travel movement feedback" on parameter page "Ax – Feedbacks" to "feedback object is passive status object".

The feedback object is enabled. A telegram representing the current travel movement will be transmitted in response only if the feedback object is read out by the bus.

The feedback must be set as actively transmitting.

- If a time delay after bus voltage return should be necessary, the parameter "Time delay for feedback after bus voltage return" on parameter page "Ax – Feedbacks" must be set to "yes"

The feedback of a drive movement is transmitted after a delay on bus voltage return, for example, when the drive starts moving on account of the set behaviour after bus voltage return. After the end of the time delay, the object value state last adjusted will be transmitted to the bus. No feedback telegram is transmitted during a running delay, even if the drive stops or starts moving.

- i Automatic transmission only takes place after a bus voltage return when the drive starts moving on bus voltage return or if the bus failure has caused a change to the drive movement.

Safety function

The switching / blind actuator can handle up to five different safety functions: 3 x wind alarm, 1 x rain alarm, 1 x frost alarm. Each safety function has a communication object of its own so that the functions can be activated or deactivated independently of one another. The safety functions are programmed and configured for all shutter/blind outputs together (cf. chapter "Description of channel-independent functions – Safety functions"). The different outputs of the actuator can be separately assigned to all or to individual safety functions. Only assigned outputs respond to a change in the state of the safety objects. The reactions at the beginning of an alarm ("1" telegram) can be parameterized for each alarm separately whereas the reaction at the end of an alarm ("0" telegram) can be parameterized for all alarms in common (figure 35).

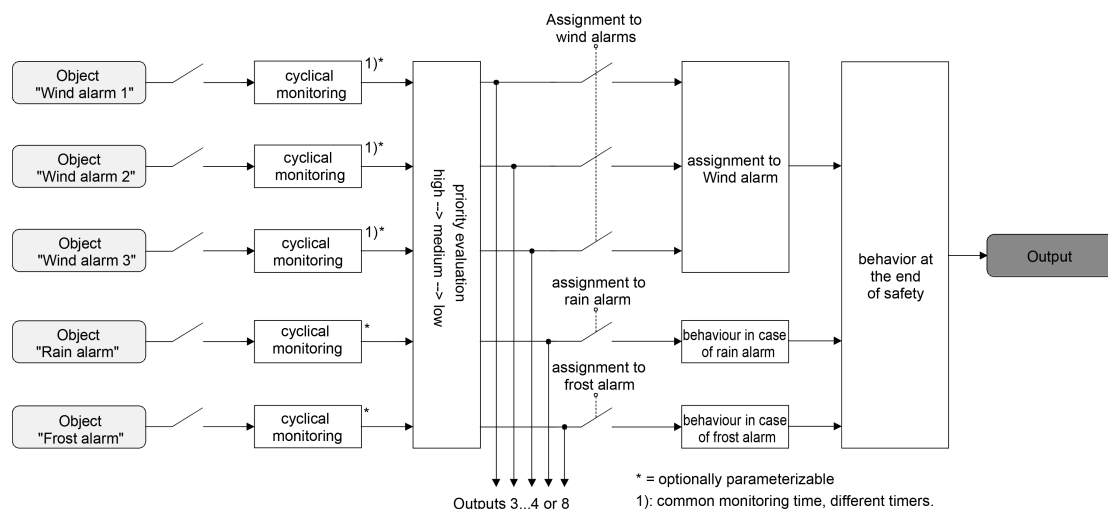

Figure 35: Function diagram of channel-oriented safety functions

An output can be assigned independently to the wind alarms, the rain alarm and the frost alarm. If an output is associated with several alarms, the preset priority decides which of the alarms will prevail and be executed. In so doing, an alarm with a higher priority overrides the alarms with the lower priorities. When safety alarm with the higher priority has ended, the safety alarm with the lower priority is executed on condition that it is active.

The order of priority of the wind alarms with respect to the frost alarm or to the rain alarm can be configured for several channels on the parameter page "Safety". The three wind alarms have the same priority with respect to one another (logic OR). The last telegram update to the wind alarm objects decides which of the wind alarms will be executed. The wind alarm is completely deactivated only after all three objects are inactive ("0").

An output in the active safety alarm state is locked, i.e. the control of the output concerned via the bus by direct operation (short-time, long-time telegram, scenes, positioning, central) or by a sun protection function is prevented. Only a forced position (for switching / blind actuator 8/16 gang only available with ETS3.0d and higher) and a manual control locally on the device itself have a higher priority so that these functions may override a safety interlock. At the end of a forced position or of a manual control, the safety reaction is re-executed if an assigned safety alarm is still active.

Assigning safety alarms

The individual safety alarms can be assigned separately for each output. The channels are assigned on parameter page "Ax – Safety" (x = number pair of output).

The safety functions must be globally enabled on the "Venetian blind outputs safety" parameter page before the output assignments are configured.

The safety function for an output must be enabled on parameter page "Ax – Enabled functions (x = number of output)". Only then are the channel-related parameters for the safety function visible.

- If an assignment to the wind alarms is necessary, set the parameter "Assignment to wind alarms" to the wind alarm or the wind alarms required.

The output is assigned to the specified wind alarms.

- If an assignment to the rain alarm is necessary, set the parameter "Assignment to rain alarm" to "yes".

The output is assigned to the rain alarm.

- If an assignment to the frost alarm is necessary, set the parameter "Assignment to frost alarm" to "yes".

The output is assigned to the frost alarm.

i If an output is assigned to an alarm which is not globally enabled, the assignment is without effect.

i Important information about the activation or deactivation of a safety alarm, about the presetting of the priority and about cyclical monitoring can be found in chapter "Channel-independent functional description – Safety functions".

Presetting the behaviour at the beginning of a safety alarm

The behaviour of an output at the beginning of a safety alarm can be parameterized separately for each alarm (wind alarms in common, rain and frost alarms separately). The alarm behaviour is preset on parameter page "Ax – Safety" (x = number pair of output). At the beginning of a safety alarm, the actuator locks the outputs concerned, i.e. control via the bus by direct operation (short time, long time telegram, scenes, positioning) or by a sun protection function is prevented.

Depending on the selected operating mode, the ETS adapts the designations of the parameter settings ("raising" ↔ "opening the louver" / "lowering" ↔ "closing the louver").

The safety functions must be globally enabled on the "Safety" parameter page.

The safety function for an output must be enabled on parameter page "Ax – Enabled functions (x = number of output)". Only then are the channel-related parameters for the safety function visible.

The behaviour in case of a safety alarm can only be adjusted, if the output concerned has been assigned to the corresponding alarm. Since there is no difference between the alarm-dependent configurations, the selection of the parameters is described below only once.

- Set the parameter "Behaviour in case of ..." to "no reaction".

At the beginning of the alarm, the output is locked and the relay of the output shows no reaction. Any movements still in progress at this instant will still be completely finished.

- Set the parameter "Behaviour in case of ..." to "raising" or "opening the louver".

The actuator raises the curtain or opens the venting louver at the beginning of the alarm and locks the output thereafter.

- Set the parameter "Behaviour in case of ..." to "lowering" or "closing the louver".

The actuator lowers the curtain or closes the venting louver at the beginning of the alarm and locks the output thereafter.

- Set the parameter "Behaviour in case of ..." to "stop".

At the beginning of the alarm, the actuator switches the relays of the output to "stop" and locks the output. A drive movement, if any, will be interrupted.

- i** The safety movement time required by an output to move the drive into the end positions is determined by the "Movement time" parameter on parameter page "Ax - Times". Like the long-time operation, a safety movement is derived from the movement time. Downward movement: movement time + 20 %; Upward movement: movement time + 20 % + configured movement time extension. Safety movements are not retriggerable.
- i** Slats of blinds are not repositioned at the end of safety movements to end positions.

Presetting the behaviour at the end of all safety alarms

The switching blind actuator ends the safety interlock of an output only after all safety alarms assigned to the output have become inactive. Thereafter, the output concerned shows the parameterized "Behaviour at the end of safety". The behaviour is configured on parameter page "Ax — Safety" (x = number pair of output) in common for all alarms.

Depending on the selected operating mode, the ETS adapts the designations of the parameter settings ("raising" ↔ "opening the louver" / "lowering" ↔ "closing the louver").

The safety functions must be globally enabled on the parameter page "Venetian blind outputs safety".

The safety function of an output must be enabled on parameter page "Ax - Enabled functions". Only then are the channel-related parameters for the safety function visible.

- Set the parameter "Behaviour at the end of safety" to "no reaction".
At the end of all safety alarms, the output is released and the relay of the output shows no reaction. Any movements still in progress at this instant will still be finished.
- Set the parameter "Behaviour at the end of safety" to "raising" or "opening the louver".
The actuator releases the output at the end of all safety alarms and raises the curtain or opens the venting louver.
- Set the parameter "Behaviour at the end of safety" to "lowering" or "closing the louver".
The actuator releases the output at the end of all safety alarms and lowers or closes the venting louver.
- Set the parameter "Behaviour at the end of safety" to "stop".
At the end of all safety alarms, the output is released and the actuator switches the relays of the output to "stop". A drive movement, if any, will be interrupted.
- Set the parameter "Behaviour at the end of safety" to "tracking the position".
At the end of all safety alarms, the output will be set to the state last adjusted statically before the safety function or to the state tracked and internally stored during the safety function. The position objects, the long time object and the scene function are tracked.
- i** Parameter setting "Position tracking": The switching / blind actuator can track absolute positions after safety release (position telegram, scene value) only if the position data are known and if the positions have been predefined. In all other cases, no reaction takes place on release of safety.
Position data can be tracked, if the output was in a defined position before the safety function or if a new position telegram was received via the position objects during the safety interlock. In the latter case, a reference movement will be executed when the safety function is enabled, if the position before or during the safety interlock was unknown. Known slat positions will also be tracked as described. This is also the case, when the height of the Venetian blind is unknown.
Long time movements (movements without position preset) will, however, always be tracked.
- i** The preset "Behaviour at the end of safety" will only be executed, if the output passes over to direct operation at the end of all safety alarms. If a sun protection function is activated (independent of the preset priority with respect to direct operation), it will be also executed.

Sun protection function

Each output of the switching / blind actuator can be separately configured for the execution of a sun protection function. Sun protection is generally realized with blinds, shutters or awnings and offers an intelligent method of shading rooms, terraces or balconies during sunshine depending on the altitude of the sun in the sky and on the intensity of the sunlight (figure 36)

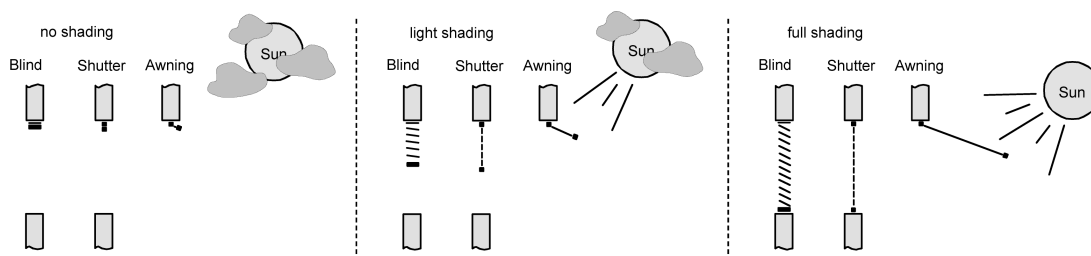

Figure 36: Sun protection principles (example)

The sun protection functions of the switching / blind actuator can be adapted many different applications. In simple applications as, for instance, in case of direction-dependent measurement of the sun's intensity by means of a brightness sensor, the curtains controlled can be closed partly or completely to prevent being disturbed by direct sunlight. In these applications, the sun protection function merely evaluates the 1-bit sun signal from the brightness or a similar sensor (e.g. weather station with limit value monitoring) and makes a drive open or close the controlled curtains by moving them into fixed configured positions or into variable positions preset via the bus.

In extended applications – for instance where the degree of shading is controlled by weather stations evaluating additionally the sun angle as a function of astro co-ordinates and presetting the blind and also the slat positions dynamically – additional communication objects are available for presetting the position in the sun protection.

Already simple sun protection applications are sufficient to permit a fixed or variable re-adjustment of the positions of Venetian blind slats for adapting the curtain to individual shading requirements. For such purpose, it is possible to preset a static slat offset in the ETS parameters, for instance, for adapting the reflection of sunlight depending on the building situation, or additionally, a dynamical slat offset via a bus communication object, for instance, for manual re-adjustment of the slat opening by persons in the room or otherwise by a central building services control system.

In all cases, the priority between an incoming sunshine telegram and the direct operation of an output (short-time, long-time telegram, scenes, positioning, central) can also be preset in the ETS. This way, a sun protection position can, for instance, be influenced by a 'manual' operation of a pushbutton sensor in the room and the sun protection function be interrupted. Alternatively, sun protection mode can therefore not be interrupted by a direct operation, i.e. the output is locked.

A sun protection function can be overridden by a safety function, a forced position (for switching / blind actuator 8/16 gang only available with ETS3.0d and higher) or also by a manual control locally on the device itself, as these functions of the blinds actuator invariably have a higher priority. At the end of one of the mentioned functions with a higher priority, the same reaction as the one at the beginning of sun protection will be re-executed, if the sun protection function is still active at this time.

Shading against sunlight is activated and deactivated via the 1-bit communication object "Sunshine / shading facade". The polarity of this object can be selected in the ETS. The sun protection is activated as soon as "sunshine" is signalled to the object depending on the preset polarity. After ETS programming or after switch-on of the supply voltage, the object must at first have data written into it by the bus also in case of inverted polarity before the sun protection can be activated.

A newly received object value (sun / beginning of shading or sun / end of shading) can optionally be evaluated with a time delay. This feature permits suppressing brief brightness variations caused, for instance, by passing clouds or by a thunderstorm. An update (from activated) of the "Sunshine / shading facade" object causes the sun protection to be reactivated, if it had been influenced and possibly been re-enabled beforehand by a direct operation in acc. with the preset priority.

The reaction of a specific output at the beginning of shading can be preset in the ETS. Amongst other things, this setting permits approaching fixed configured positions or positions preset via the bus and thus variable. Variable positions for sun protection purposes can be preset, for instance, by means of pushbutton sensors or visualisations. In addition, it is possible in case of a defined sun protection positioning movement to have a reference movement executed by forced control. This ensures that identical blind positions are approached synchronously by different outputs in case of a sun protection positioning movement. The reaction at the end of a shading task can be preset as well. In this situation, the curtain can pass into an end position, be stopped or shown no special reaction. Tracking of positions is possible as well.

By means of a priority setting in the ETS configuration, it can be specified whether the sun protection function can be influenced by direct operation or whether the corresponding output is locked by a telegram "Sunshine / shading facade" (for switching / blind actuator 8/16 gang only available with ETS3.0d and higher) in the sun protection position. Basically, the "Manual control", "Forced position" and "Safety" functions have a higher priority so that these functions can override, but not terminate a sun protection. Thus, the sun protection function is re-executed at the end of a function with a higher priority, if the object "Sunshine / shading facade" continues to signal the presence of sunshine.

- i** After an ETS programming operation, the sun protection function is always deactivated. Activated sun protection (independent of the selected priority with respect to direct operation) remains active even after a bus voltage failure as long as the mains voltage supply is still on. The sun protection reaction last executed will therefore be executed again at the end of a temporary or permanent manual control (if enabled in case of bus failure), even if there is no bus voltage.

The schematic diagram of the sun protection (figure 37) is intended to illustrate, for example, how sensor components can be integrated into a simple sun protection configuration.

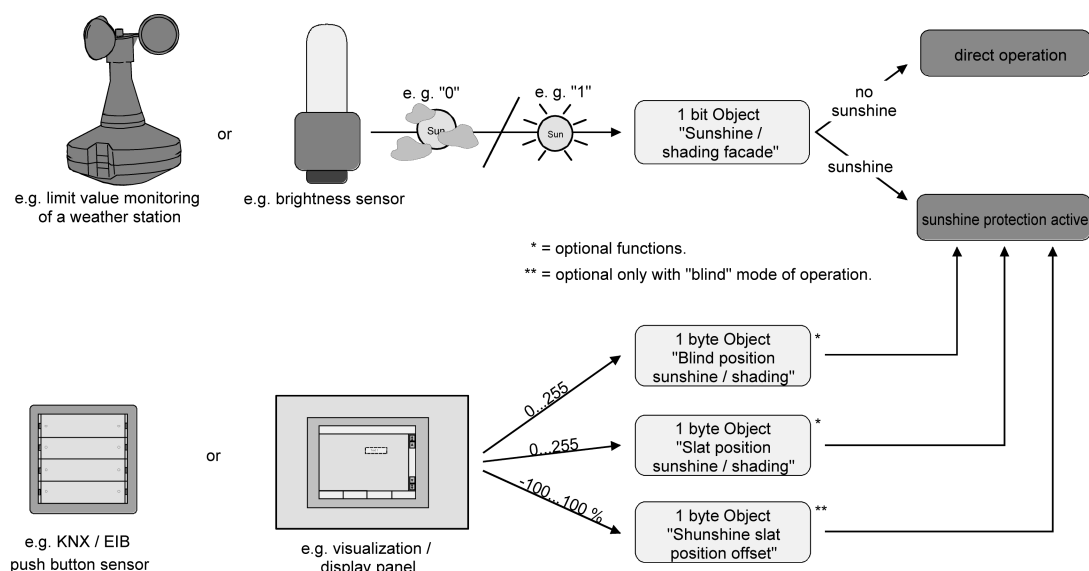

Figure 37: Schematic diagram illustrating of the sun protection configuration

The function diagram (figure 38) shows all possible functions of the sun protection. For reasons of clarity, the functions with a higher priority (manual control, forced position, safety function) are not shown in the diagram.

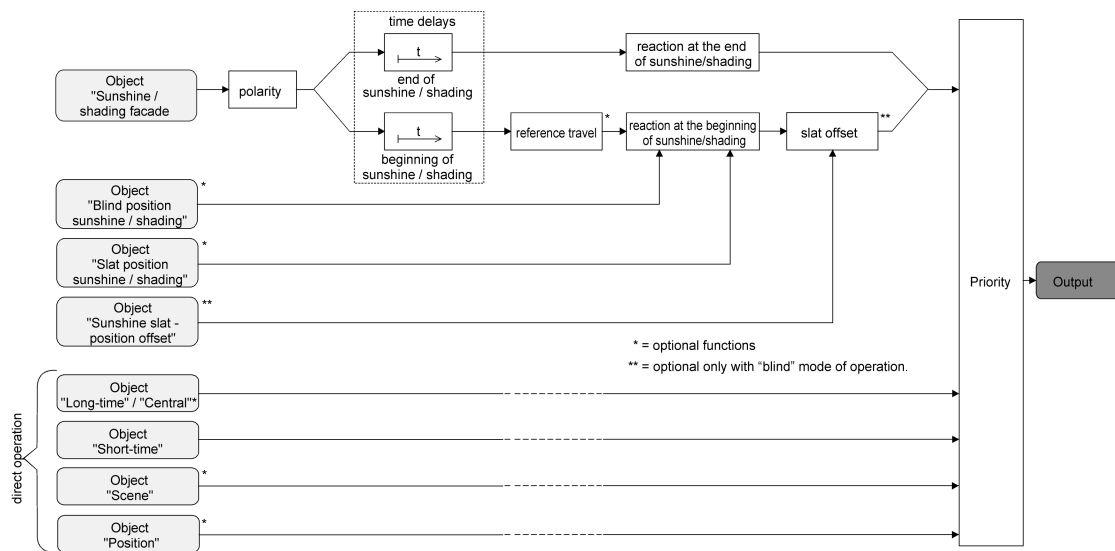

Figure 38: Function diagram illustrating the sun protection

Presetting the priority of the sun protection

The priority of the sun protection function can be set separately for each output. In the simple sun protection, the priority relations between the "Sunshine / shading facade" object and the objects of direct operation (short-time, long-time, central or position telegram, scene recall) must be configured.

For the sun protection parameters to be visible, the sun protection function must be enabled on parameter page "Ax – Enabled functions (x = number pair of output).

- Set the parameter "Priority of sun protection with respect to direct operation" on parameter page "Ax - Sun protection" to "same priority".

The sun protection mode can be overridden at any time by direct operation. In the same way, the sun protection overrides the direct operation, when a new "sunshine" telegram is received via the "Sunshine / shading facade" object and when a configured time delay, if any, has elapsed. If the sun protection function is overridden by a direct operation, the preset behaviour "Reaction at the end of sunshine / shading" will not be executed.

- Set the parameter "Priority of sun protection with respect to direct operation" on parameter page "Ax - Sun protection" to "higher priority".

An active sun protection will override a direct operation. The sun protection mode can therefore not be interrupted by a direct operation. Direct operation will be possible again only after the sun protection function is terminated.

- Set the parameter "Priority of sun protection with respect to direct operation" on parameter page "Ax - Sun protection" to "lower priority".

A direct operation can at any time override the sun protection mode. If the sun protection function is overridden by a direct operation, the preset behaviour "Reaction at the end of sunshine / shading" will not be executed. The sun protection function can only be reactivated after an enabling movement controlled by a direct operation has been effected and after a new "sunshine" telegram has been received via the "Sunshine / shading facade" object. Attempts to activate the sun protection function are ignored for as long as the enabling movement has not taken place.

On the enabling movement:

An enabling movement is an accomplished long-time movement into the upper end position which has been initiated by the objects "Long time operation" or "Central travel control". A manual control, an upward travel movement after bus voltage failure or bus voltage return, a position approach to "0 %" or an upward travel movement after releasing enabling of forced-position or safety functions have no enabling effect.

The sun protection is not enabled if the enabling movement has been interrupted. The sunshine protection function will be also be disabled if the output has been readjusted again by a direct operation after an accomplished enabling movement.

After programming with the ETS or after switching on the mains supply voltage (bus voltage and supply voltage), the sunshine protection function is always enabled.

- i** Manual local operation on the device itself, the forced position function and the safety functions have a fixed priority higher than that of the sun protection. The sun protection is overridden – but not terminated – by a function with a higher priority. After the end of the function with the higher priority the reaction at the beginning of sun protection will therefore be executed again, if the sun protection is still active at this time.
- i** With the settings "same priority" or "lower priority", the sun protection can be overridden by a direct operation only if the direct control action can be executed at once. A direct operation will therefore not override the sun protection during a manual control locally on the device, an active forced position function or an active safety function.
- i** Parameter setting "same priority" or "lower priority": A variable preset of curtain and slat positions or of a slat offset via the bus at the beginning of sunshine / shading shows no reaction at the output, if the sun protection was overridden by direct operation. However, the position data or offsets received are stored internally so that the new positions will be approached on reactivation of the sun protection.

Presetting the polarity of the "Sunshine / shading facade" object

The telegram polarity of the "Sunshine / shading facade" object can be preset separately for each output. This means that an adaptation to the signals from existing sensors or weather stations is possible in the sun protection mode.

For the sun protection parameters to be visible, the sun protection function must be enabled on parameter page "Ax – Enabled functions (x = number pair of output).

- Set the parameter "Polarity of 'Sunshine / shading facade' object" on parameter page "Ax - Sun protection" to the required telegram polarity.

The sunshine signal is evaluated in accordance with the preset priority.

- i** In the sun protection mode, an update (from activated to activated) of the "Sunshine / shading facade" object causes the sun protection to be reactivated, if it had been influenced and possibly been re-enabled beforehand by a direct operation in acc. with the preset priority.

Presetting a time delay for beginning and end of sunshine / shading

The telegram received via the object "Sunshine / shading facade" for activation or deactivation of shading (depending on polarity) can be evaluated with a time delay separately for each output.

For the sun protection parameters to be visible, the sun protection function must be enabled on parameter page "Ax – Enabled functions (x = number pair of output).

- Set the parameter "Time delay at the beginning of sunshine / shading" on parameter page "Ax – Beginning of sun protection" to the required delay time.
The telegram for activation of the sun shading will be evaluated with a delay corresponding to the setting.
 - Set the parameter "Time delay at the end of sunshine / shading" to the required delay time.
The telegram for deactivation of the sun protection will be evaluated with a delay corresponding to the setting.
- i** A setting of "0" in the parameters deactivates the respective delay time. In this case, the state of the sunshine signal is evaluated immediately.
- i** An update of the "Sunshine / shading facade" object causes the sun protection to be reactivated in consideration of the delay time, if the sun protection had been influenced or aborted beforehand by a direct operation because of the same or a lower priority.

Presetting the reaction at the beginning of sunshine / shading

The behaviour of the output at the beginning of sunshine / shading – if applicable, after the end of the delay time – can be configured in the ETS separately for each output. In the sun protection mode, the behaviour will be executed, when the sun protection function is activated after receiving a new sunshine signal. The reaction will not be executed if a function with a higher priority is active at the time the sun shading is received.

The reaction at the beginning of sunshine / shading is preset on parameter page "Ax – Beginning of sun protection" (x = number pair of output). Depending on the selected mode of operation, the ETS adapts the designations of the parameter settings ("raising" ↔ "opening the louver" / "lowering" ↔ "closing the louver"). The ETS equally adapts the parameter selection depending on the preset mode of operation.

For the sun protection parameters to be visible, the sun protection function must be enabled on parameter page "Ax – Enabled functions (x = number pair of output)".

- Set the parameter "Reaction at the beginning of sunshine / shading" to "no reaction".
At the beginning of shading, the output switches over to sun protection while the relays of the output show no reaction. Any movements still in progress at this instant will still be finished.
- Set the parameter "Reaction at the beginning of sunshine / shading" to "raising" or "opening the louver".
At the beginning of shading, the actuator raises the curtain or opens the venting louver.
- Set the parameter "Reaction at the beginning of sunshine / shading" to "lowering" or "closing the louver".
At the beginning of shading, the actuator lowers the curtain or closes the venting louver.
- Set the parameter "Reaction at the beginning of sunshine / shading" to "stop".
At the beginning of shading, the actuator switches the relays of the output to the "stop" position. A drive movement, if any, will be interrupted.
- Set the parameter "Reaction at the beginning of sunshine / shading" to "internal scene recall". The number of the scene to be recalled must be specified in the parameter "Scene number (1...8)".
At the beginning of shading, the switching / blind actuator recalls the position value for the output concerned which was preset in the scene configuration. This is not a scene recall as in direct operation, but only an approach to the corresponding scene position value.
- Set the parameter "Reaction at the beginning of sunshine / shading" to "fixed position".
At the beginning of shading, the switching / blind actuator recalls a fixed position value for the output concerned.

- i** In the "Venetian blinds" operating mode, the setting "fixed position" can be selected separately for the height of the Venetian blind and for the slat position. For this reason, the ETS adapts the parameter selection and enlarges the setting options in this operating mode.
- "Fixed position" only: Set the parameter "Fixed position of Venetian blind", "Fixed position of roller shutter/awning" or "Fixed position of venting louver" to "as parameter value". Thereafter, set the parameter "Position of Venetian blind (0...100%)", "Position of roller shutter/awning (0...100%)" or "Position of venting louver (0...100%)" to the desired position.
At the beginning of shading, the output invariably approaches the configured position value.
 - "Fixed position" only: Set the parameter "Fixed position of Venetian blind", "Fixed position of roller shutter/awning" or "Fixed position of venting louver" to "no change of current position".
At the beginning of shading, the last set position of the Venetian blind height, the roller shutter, awning or venting louver will be maintained.
 - "Fixed position" and operating mode = "Venetian blind" only: Set the parameter "Fixed slat position (0...100%)" to the desired position value.
At the beginning of shading, the output invariably moves the slats to the configured position after the height of the Venetian blind has been adjusted.
 - Set the parameter "Reaction at the beginning of sunshine / shading" to "variable position".
At the beginning of shading, the switching / blind actuator recalls the variably specified position value for the output concerned. The variable specification of the Venetian blind height, the roller shutter, awning or venting louver position takes place via the separate communication object "...pos. sunshine / shading" (in the "Venetian blind" operating mode for the slats also using the separate object "Slat position sunshine / shading").
- i** In the "Venetian blind" operating mode, the "variable position" setting can be selected separately for the height of the Venetian blind and for the slat position. For this reason, the ETS adapts the parameter selection and enlarges the setting options in this operating mode.
- i** The behaviour preset in this parameter will only be executed, if no function with a higher priority (e.g. safety) is activated at the time of shading.
- i** "Internal scene recall" setting: For this setting, the scene function of the output must be enabled in the ETS. Otherwise, the positions approached at the beginning of sun shading are undefined positions. The scene position values stored in the actuator by a scene storage function will be approached as well. A delay configured for scene recalls has no influence on the recall of the scene value by the sun protection function.
- i** "Variable position" setting: After an ETS programming operation or after switch-on of the supply voltage, the objects "Sunsh./shading ... position" and "Sunsh./ shading slat position" must receive position values from the bus. Otherwise the actuator does not position itself at the start of sun shading as it does not have any valid position data.
When the actuator is in operation, the position data can be updated at any time via the bus even if the sun protection is active (e.g. by a weather station for the purpose of sun position tracking). The switching / blind actuator will then immediately approach the newly received positions if the sun protection is active. If a function with a higher priority is active, the actuator stores the newly received position values and approaches them during a later shading operation.
The position data last received are not lost during a failure of the bus voltage (mains supply voltage is on).

Presetting a forced reference movement in the sun protection mode

If needed, a reference movement can be executed by forced-control in the sun protection mode at the beginning of a shading cycle, if fixed or variable position values or scene positions are to be approached. The execution of a reference movement by forced control at the beginning of shading can be used in a sun protection positioning operation to ensure that the curtains or slats are moved synchronously by different outputs to identical positions (e.g. in a long row of windows). Without the execution of reference movement by forced control, there might otherwise be positioning inaccuracies with a negative effect on the overall appearance of a building facade with the blinds let down.

A reference travel by forced control will always be executed in the sun protection mode, when the beginning of shading is signalled for the first time via the "Sunshine/shading facade" object. Updates of the object from 'sun is shining' to 'sun is shining' do not initiate a reference movement if, at this time, the output is still in the sun protection position.

A reference travel by forced control will always be executed in the sun protection mode, when the beginning of shading is signalled for the first time via the "Sunshine/shading facade" object. Updates of the object from 'sun is shining' to 'sun is shining' do not initiate a reference movement if, at this time, the output is still in the sun protection position.

A reference movement by forced control will always be executed for synchronisation purposes as described and also in such cases where the position data of the blind or the slats are known. No reference movement by forced control will be executed at the end of shading.

For the sun protection parameters to be visible, the sun protection function must be enabled on parameter page "Ax – Enabled functions (x = number pair of output).

The reaction at the beginning of sunshine/shading must be configured for fixed or variable position preset or for the recall of an internal scene.

- Set the parameter "reference movement before every sun protection positioning operation ?" on parameter page "Ax Beginning of sun protection" (x = number of output) to "yes".
At the beginning of shading there is always a reference movement by forced control as described. The preset position will be approached after the end of the reference movement.
- Set the parameter "reference movement before every sun protection positioning operation ?" on parameter page "Ax Beginning of sun protection" (x = number pair of output) to "No".
A reference movement at the beginning of sun protection will only be executed, if the position data are unknown, for instance, after an ETS programming operation or after switch-on of the power supply. In all other cases, the preset shading position will be approached immediately.

- i** A reference movement is the time required for a travel movement into the upper end position increased by 20 % and additionally by the configured travel time extension. A reference travel is not retriggerable.
- i** Variable position preset: No reference movement will be executed, if new position values are preset via the bus while the sun protection is active.
- i** "Venetian Blind" operating mode: A terminated reference movement of for the height of the Venetian blind synchronises at the same time also the slat position.

Slat offset in the sun protection mode (only "Blind" mode of operation)

An offset can be specified for the slat position at the start of sun shading separated for each output, if fixed or variable slat position values are to be approached.

If necessary, the slat offset can correct the fixed or variable nominal slat position and thus allow the creation of an individual shading situation, when the sun protection is active. The offset can be preset in two ways...

- The slat offset can be configured statically in the ETS. The configuration of a static offset value allows variation of the degree of shading in those parts of the building that are not exposed to full sunshine due to objects in front of the building. The variable slat angle adjusted by the sun protection control or the fixed angle specified in a parameter can thus be overridden so that the slats are always opened a bit wider than originally preset. Alternatively, the slats can also be closed completely by means of the static offset if too much sunlight is reflected into the room.
- The slat offset can additionally be adapted by the bus via the separate communication object "Sunshine slat position offset". In this way, the desired slat offset can also be adjusted during an active shading cycle and independent of a direct operation as, for instance, the short time mode. Thus, it is possible, for instance, that persons in a room can correct the slat angle at any time 'manually' and individually by selecting another preset value at a touch sensor or a visualisation. An offset preset via the object overwrites the value configured in the ETS.

The preset offset is taken into account for each slat positioning during an active shading cycle (beginning of sun / shading) and added to the predefined nominal slat position. The offset value can be varied within a range from -100 % ... 0 ... 100 % so that the slats can be moved in both directions into the respective end positions (figure 39). At an offset of "0 %", the actual slat position is always identical with the predefined nominal slat position for sun protection purposes.

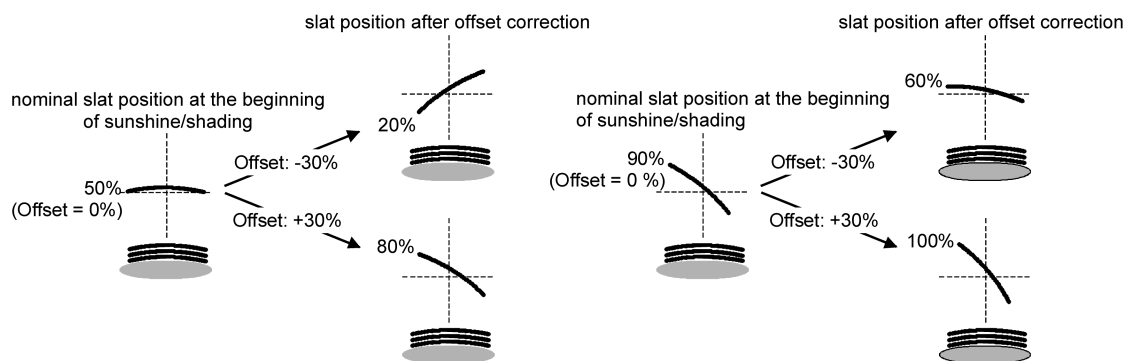

Figure 39: Functional principle of slat offset
(example showing slat type 1 / slat type 2 identical)

The position value actually adjusted with the offset after adding the slat position value is always between 0 and 100 %. Minimum and maximum position are thus determined by the slat end positions. These limits cannot be exceeded by specifying an greater offset. Example (figure 39)

... Slat position at start of sun / shading = 90 %

Slat position offset at start of sun / shading = +30 %

-> The resulting slat position is 100% as the end position is reached.

In acc. with the KNX datapoint type 6.001 (DPT_Percent_V8) the data format of the communication object "Sunshine slat position offset" permits presetting positive and negative values in a range of -128 ... 0 ... +127. The actuator interprets the value received directly as an offset in %. Values below 100 or above +100 are limited to the minimum (-100 %) and maximum offset (+100 %) and evaluated accordingly.

An offset preset via the object overwrites the value configured in the ETS. In the event of a bus voltage failure or a mains voltage failure of the actuator, an offset value received via the

communication object can be stored internally in a non-volatile memory so that the offset value last received is not lost even in case the complete power supply fails (bus voltage and mains voltage failure). As an alternative, the offset preset via the bus can be reset (0 %) in the event of a power supply failure with the result that the value configured in the ETS is again used in operation. The offset reaction preset in the event of bus or mains voltage failure can be parameterized in the ETS.

For the sun protection parameters to be visible, the sun protection function must be enabled on parameter page "Ax – Enabled functions (x = number pair of output).

The reaction at the beginning of sunshine/shading must be configured for fixed or variable position preset.

- Set the parameter "Offset with fixed and variable slat position" on parameter page "Ax - Beginning of sun protection" to "no offset".

The offset correction is deactivated. During shading (beginning of sunshine/shading), the fixed or variable slat position will be approached without offset correction. The other parameter relating to the offset are blanked out.
 - Set the parameter "Offset with fixed and variable slat position" to "offset as configured".

The static offset correction based on the parameter preset in the ETS is activated. During every shading operation (beginning of sunshine/shading), the nominal slat position is always corrected by the configured offset value.
 - Set the parameter "Offset with fixed and variable slat position" to "offset as configured and via object".

The offset correction based on the parameter preset in the ETS and via the object is activated. The slat offset is preset by a fixed value configured in the ETS and can be adapted dynamically with a separate communication object. During every shading operation (beginning of sunshine/shading), the nominal slat position is always corrected by the preset offset value.
 - Set the parameter "Slat offset position (-100 ... 100 %)" on parameter page "Ax Beginning of sun protection" to the desired offset value.

The configured value defines the static offset correction of the slat position. The configured value can be re-adjusted via the "Sunshine slat position offset" object, if the communication object has been enabled.
 - Set the parameter "Store slat position offset adjusted via object in case of bus / mains voltage failure ?" to "No".

The value received via the object will only be stored temporarily in volatile memory. The value received only replaces the configured value until the actuator is reinitialised (bus or mains voltage return, if both were previously switched off). After the initialisation, the offset value configured in the ETS will be used again.
 - Set the parameter "Store slat position offset adjusted via object in case of bus / mains voltage failure ?" to "Yes".

The value received via the object will be stored in case of bus or mains voltage failure in a non-volatile memory of the actuator. The originally configured offset value is definitely overwritten in the process. Only a new ETS programming operation sets the offset back to the configured value.
- i** An offset value received via the bus is stored temporarily or permanently in the actuator and taken into account during the next shading operation. The reception of an offset value during an active shading phase (beginning of sunshine/shading active) results in an immediate and 'visible' correction of the offset angle by the output.
- i** After an ETS programming operation, the offset is always set to the value configured in the ETS.

- i** Storage of the slat offset position in case of bus/mains voltage failure: The offset value preset via the object is stored only if one part of the supply voltage (mains or bus) is still present or if the supply fails completely after the mains voltage has been available before without interruption for at least 20 seconds after the last reset (storage capacitors sufficiently charged for storage purposes). In all other cases nothing is stored!
- i** The slat offset has no influence on the behaviour of an output at the end of a shading phase (end of sunshine/shading).

Presetting the reaction at the end of sunshine / shading

At the end of the shading phase – if applicable, after the end of the delay time – the output concerned will show the preset reaction, if no function with a higher priority is active at the time of deactivation. The preset reaction will also not be executed at the end of sun shading, if the sunshine signal is overridden on account of priority settings by a direct operation.

The reaction at the end of sun shading is preset on parameter page "Ax - Sun protection end" (x = number pair of output). Depending on the selected mode of operation, the ETS adapts the designations of the parameter settings ("raising" ↔ "opening the louver" / "lowering" ↔ "closing the louver").

For the sun protection parameters to be visible, the sun protection function must be enabled on parameter page "Ax – Enabled functions (x = number of output).

- Set the parameter "Reaction at the end of sunshine / shading" to "no reaction".
At the end of shading, the relay of the output shows no reaction. Any movements still in progress at this instant will still be finished.
- Set the parameter "Reaction at the end of sunshine / shading" to "raising" or "opening the louver".
At the end of shading, the actuator raises the curtain or opens the venting louver.
- Set the parameter "Reaction at the end of sunshine / shading" to "lowering" or "closing the louver".
At the end of shading, the actuator lowers the curtain or closes the venting louver.
- Set the parameter "Reaction at the end of sunshine / shading" to "stop".
At the end of shading, the actuator switches the relays of the output to the "stop" position. A drive movement, if any, will be interrupted.
- Set the parameter "Reaction at the end of sunshine / shading" to "position tracking".
At the end of shading, the output will be set to the state last adjusted statically before sun protection or to the state tracked and internally stored during sun protection. The position objects, the long time object and the scene function are tracked.

- i** The behaviour preset in this parameter will only be executed, if no function with a higher priority (e.g. safety) is activated when the sun protection is enabled or when a direct operation has not overridden the sunshine signal on account of priority settings.
- i** Parameter setting "Position tracking": The switching / blind actuator can track absolute positions (position telegram, scene value) at the end of sun protection only if the position data are known and if the positions have been predefined. There is otherwise no reaction at the end of sun shading.
Position data can be tracked, if the output was in a defined position before the sun protection function or if a new position telegram was received via the position objects during the sun protection. In the latter case, a reference movement will be executed at the end of sun protection, if the position before or during the sun protection was unknown. Known slat positions will also be tracked as described. This is also the case, when the height of the Venetian blind is unknown.
Long time travel movements (movements without position preset) will always be tracked.

Sun protection application examples

This chapter describes different applications of the sun protection function of the room actuator in combination with the Jung KNX/EIB weather station (order no. 2224 RMD W) and the combination sensor (order no. WS 10 KS...).

The following section contains sketches for each application of which communication objects of the weather station should be connected with the room actuator.

Information on the appropriate configuration of the KNX/EIB weather station can be found in the appropriate product documentation.

- I. Sun protection with brightness limit value monitoring and fixed sun protection positions:

The limit value monitoring function of the weather station is used. The weather station transmits a "1" telegram via the "Limit value 1 [Sun...]" to the bus when a preset brightness limit value is exceeded. This activates the shading function in the switching / blind actuator and the corresponding fixed sun protection position set for the blind. In addition, the fixed slat position is recalled in the "Venetian blind" operating mode of the switching / blind actuator.

When the brightness drops below the limit value for the measured brightness (with hysteresis, if programmed), the weather station transmits the value "0" to the bus. This deactivates the shading function in the switching / blind actuator and the corresponding reaction at the end of sunshine /shading will be executed. The communication objects should be interconnected according to specifications (figure 40).

Required programming for switching / blind actuator (unlisted configuration is optional):

- Simple or extended sun protection,
- Polarity of the "Sunshine / shading facade" object = "1" sunshine,
- Reaction at the beginning of sunshine / shading = fixed positions,
- Configure fixed positions.

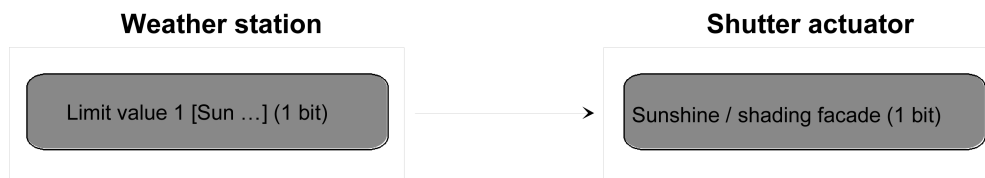

Figure 40: Programming of the communication objects for application example I.

- II. Sun protection with shading control and fixed sun protection positions:

The shading control of the weather station is used. When the preset basic brightness for shading operations is exceeded, the weather station transmits a 1-bit telegram of value "1" via the "Shading facade [shading control facades 1-4]" to the bus. This activates the shading function in the switching / blind actuator and the corresponding fixed sun protection position set for the blind. In addition, the fixed slat position is recalled in the "Venetian blind" operating mode of the switching / blind actuator.

When the brightness drops below the basic brightness for shading operations (with hysteresis, if programmed), the weather station transmits the value "0" to the bus. This deactivates the shading function in the switching / blind actuator and the corresponding reaction at the end of sunshine /shading will be executed. The communication objects should be interconnected according to specifications (figure 41).

Required programming for switching / blind actuator (unlisted configuration is optional):

- Polarity of the "Sunshine / shading facade" object = "1" sunshine,
- Reaction at the beginning of sunshine / shading = fixed positions,
- Configure fixed positions.

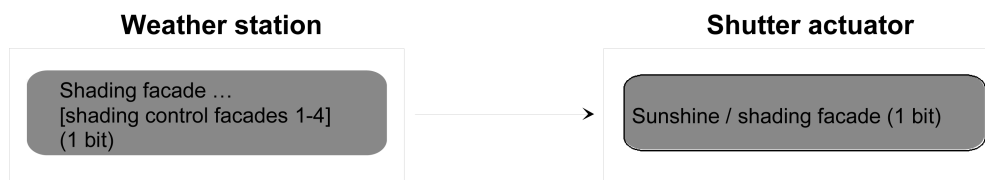

Figure 41: Programming of the communication objects for application example II.

- III. Sun protection with shading control and fixed blind height and variable slat position tracking:

The shading control of the weather station is used. The blinds connected to the switching / blind actuator are slatted blinds. When the basic brightness for shading operations is exceeded, the weather station transmits a 1-bit telegram of value "1" via the "Shading facade [shading control facade 1-4]" to the bus. This activates the shading function in the switching / blind actuator and the corresponding fixed sun protection position set for the venetian blind height.

The individual facade control of the weather station transmits additionally the slat position to be preset for sun-dependent slat tracking via the 1-byte object "Slat position (%) facade [individual control facade ...]" to the bus. This sets the slat position required in the switching / blind actuator for sun shading.

When the brightness drops below the basic brightness for shading operations (with hysteresis, if programmed), the weather station transmits the value "0" via the "Shading facade [shading control facade 1-4]" object to the bus. This deactivates the shading function in the switching / blind actuator and the corresponding reaction at the end of sunshine /shading will be executed.

Ideally, the telegram "Slat position (%) facade [individual facade control ...]" = "0 %" is suppressed in the weather station by means of a parameter. The extra slat positioning movement might otherwise adversely affect the behaviour of the output at the end of shading (possibly brief bucking).

The communication objects should be interconnected according to specifications (figure 42).

Required programming for switching / blind actuator (unlisted configuration is optional):

- Polarity of the "Sunshine / shading facade" object = "1" sunshine,
- Reaction at beginning of sun / shading = Venetian blind position fixed / slat position variable,
- Configure fixed position of Venetian blind.

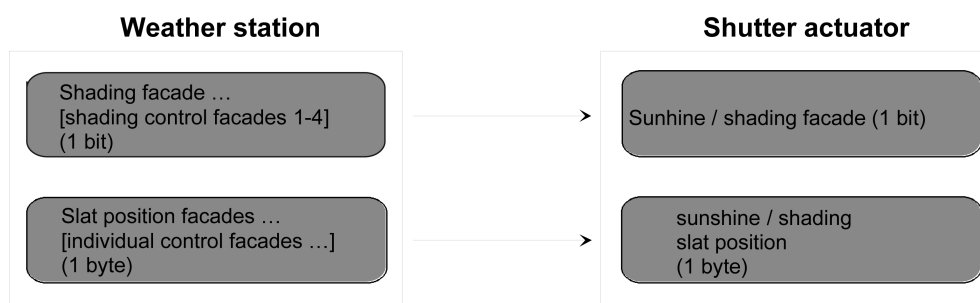

Figure 42: Programming of the communication objects for application example III

- IV. Sun protection with shading control and variable blind height and variable slat position tracking:

The shading control of the weather station is used. The blinds connected to the switching / blind actuator are slatted blinds. When the basic brightness for shading operations is exceeded, the weather station transmits a 1-bit telegram of value "1" via the "Shading facade [shading control facade 1-4]" to the bus. The switching / blind actuator activates the shading function.

The individual facade control of the weather station transmits additionally the slat position to be preset for sun-dependent slat tracking via the 1-byte object "Slat position (%) facade [individual control facade ...]" and the Venetian blind height to be adjusted via the 1-byte object "Shading facade curtain height threshold/position [individual control facade ...-]" to the bus. This sets the slat position required in the switching / blind actuator for sun shading as well as the venetian blind height required for shading.

When the brightness drops below the basic brightness for shading operations (with hysteresis, if programmed), the weather station transmits the value "0" via the "Shading facade [shading control facade 1-4]" object to the bus. This deactivates the shading function in the switching / blind actuator and the corresponding reaction at the end of sunshine /shading will be executed.

Ideally, the telegrams "Slat position (%) facade [individual facade control ...]" = "0 %" and "Shading facade blind height threshold/position [individual control facade ...]" = 0 % are suppressed in the weather station at the end of shading by means of a parameter. The extra Venetian blind and slat positioning movement might otherwise adversely affect the behaviour of the output at the end of shading (possibly brief bucking).

The communication objects should be interconnected according to specifications (figure 43).

Required programming for switching / blind actuator (unlisted configuration is optional):

- Polarity of the "Sunshine / shading facade" object = "1" sunshine,
- Reaction at beginning of sun / shading = Venetian blind position variable, slat position variable,

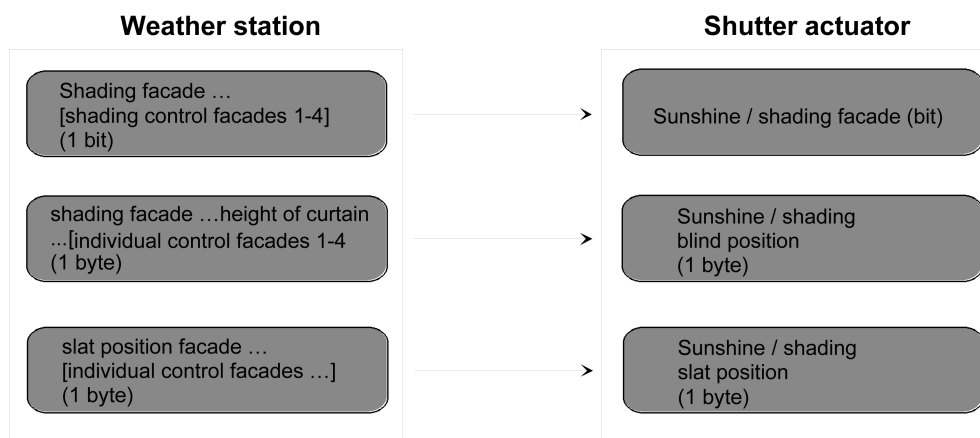

Figure 43: Programming of the communication objects for application example IV

- V. Sun protection with shading control and variable blind height and fixed slat position:

The shading control of the weather station is used. The blinds connected to the switching / blind actuator are slatted blinds. When the basic brightness for shading operations is exceeded, the weather station transmits a 1-bit telegram of value "1" via the "Shading facade [shading control facade 1-4]" to the bus. This activates the shading function in the switching / blind actuator and sets the corresponding fixed sun protection position for the slat angle.

The individual facade control of the weather station transmits additionally the Venetian blind height to be adjusted via the 1-byte object "Shading facade blind height threshold/position [individual control facade ...]" to the bus. This sets the slat position required in the switching / blind actuator for shading. When the brightness drops below the basic brightness for shading operations (with hysteresis, if programmed), the weather station transmits the value "0" via the "Shading facade [shading control facade 1-4]" object to the bus. This deactivates the shading function in the switching / blind actuator and the corresponding reaction at the end of sunshine /shading will be executed.

Ideally, the telegram "Slat position (%) facade [individual facade control ...]" = 0 % is suppressed in the weather station at the end of shading by means of a parameter. The extra Venetian blind positioning movement might otherwise adversely affect the behaviour of the output at the end of shading (possibly brief bucking).

The communication objects should be interconnected according to specifications (figure 44).

- Required programming for switching / blind actuator (unlisted configuration is optional);
- Polarity of the "Sunshine / shading facade" object = "1" sunshine,
 - Reaction at beginning of sun / shading = Venetian blind position variable, slat position fixed,
 - Configure fixed slat position.

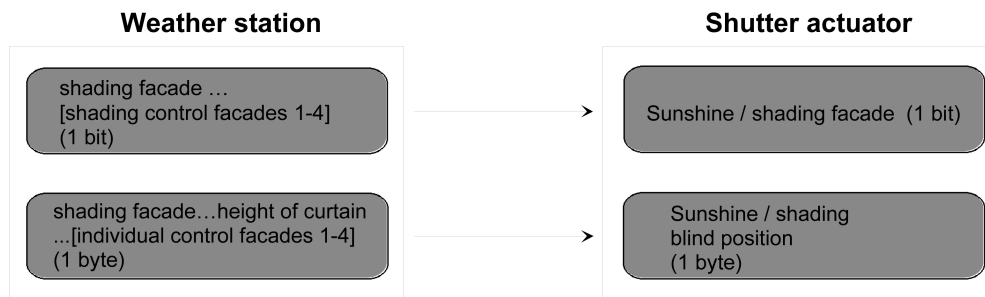

Figure 44: Programming of the communication objects for application example V

Scene function (for switching / blind actuator 8/16 gang only available with ETS3.0d and higher).

An actuator can hold up to 8 scenes for each output and store scene position values for the height of a blind, shutter or awning or the position of a venting louver. In the 'Venetian blinds' mode, the user can also preset slat positions. The scene values are recalled or stored via a separate scene extension object by means of extension telegrams. A scene recall can optionally take place after a delay.

The datapoint type of the extension object permits addressing a maximum of 64 scenes. This means that, in the configuration of a scene, it is possible to specify which scene number (1...64) contacts the internal scene (1...8).

The scene function must be enabled on parameter page "Ax - Enabling functions" (x = number pair of output) for each output in order for the required communication objects and parameters (on the parameter page "Ax - Scenes") to be visible.

Like the output control via short time, long time, central or position telegrams, the scene function should be assigned to direct operation. For this reason, a recalled scene position can be overridden by a manual control, a forced position (for switching / blind actuator 8/16 gang only available with ETS3.0d and higher) or a safety function at any time. The scene position last recalled can also be readjusted by other telegrams of the direct operation mode. The priority of direct operation and also of the scene function can be parameterized with respect to the sun protection function (cf. "Sun protection function").

Presetting a scene recall delay for the scene function

Each scene recall of an output can optionally also be delayed. With this feature, dynamical scene sequences can be configured if several outputs are combined with cyclical scene telegrams.

The scene function must be enabled on parameter page "Ax – Enabled functions (x = number pair of output)".

- Set the parameter "Delay scene recall?" on parameter page "Ax – Scenes" to "yes".

The delay time is now activated and can be configured separately. The delay only influences the scene recall of the output. The delay time is started on arrival of a recall telegram. The corresponding scene will be recalled and the output set to the respective scene position value only after this time has elapsed.

- i** Each scene recall telegram restarts the delay time and retriggers it. If a new scene recall telegram is received while a delay is active (scene recall not yet executed), the old (and not yet recalled scene) will be rejected and only the scene last received executed.
- i** The scene recall delay has no influence on the storage of scene values. A scene storage telegram within a scene recall delay terminates the delay and thus the scene recall.
- i** In case of bus voltage failure, all time functions will be stopped. Therefore, all scene recalls that are still in the delay stage will be aborted. A scene recall received shortly before bus voltage failure is then lost, if the corresponding delay has not yet elapsed. A delayed scene recall will also be aborted, if a function with a higher priority (manual control, forced position, safety, sun protection, if the priority is the same as or higher than that of direct operation) is activated. The scene recall is nevertheless stored internally so that the scene positions last recalled can be tracked at the end of a higher-ranking function.

Presetting the ETS download behaviour for the scene function

During storage of a scene, the scene values are stored permanently in the device (cf. "Presetting the storage behaviour for scene functions"). To prevent the stored values from being replaced during ETS programming of the application or of the parameters by the originally programmed scene position values, the actuator can inhibit overwriting of the scene values. As an alternative, the original values can be reloaded into the device during each programming run of the ETS.

The scene function must be enabled on parameter page "Ax – Enabled functions (x = number pair of output)".

- Set the parameter "Overwrite the values values in the device during ETS download ?" on the parameter page "Ax - Scenes" to "Yes".

During each ETS programming of the application or of the parameters, the scene values parameterized in the ETS for the output concerned will be programmed into the actuator. Scene values stored in the device by means of a storage function will be overwritten, if any.

- Set the parameter "Overwrite the values values in the device during ETS download ?" on the parameter page "Ax - Scenes" to "No".

Scene values stored in the device with a storage function will be maintained. If no scene values have been stored, the position values last programmed in the ETS remain valid.

- i** When the actuator is put into operation for the first time, this parameter should be set to "yes" so that the output is initialized with valid scene values. In the switching / blind actuator as delivered, the scene positions are internally set to default values as in the ETS product database.

Presetting scene numbers

The datapoint type of the scene extension object permits addressing of up to 64 scenes max. For this reason, the scene number (1...8) with which the scene is addressed, i.e. recalled or stored, must be determined for each internal scene (1...64) of the output.

The scene function must be enabled on parameter page "Ax – Enabled functions (x = number pair of output).

- Set the parameter "Scene y activatable by scene number" (y = number of the scene (1...8)) on parameter page "Ax – Scenes" for each scene to the numbers with which the scenes are to be addressed.

A scene can be addressed with the configured scene number. A setting of "0" deactivates the corresponding scene so that neither recalling nor storage is possible.

- i** If the same scene number is configured for several scenes, only the scene with the lowest internal scene number (1...8) will be addressed. The other internal scenes will be ignored in this case.

Presetting scene positions

Moreover, the position value (Venetian blind, roller shutter, awning, venting louver position) to be set for the output in case of a scene recall must be specified as well. In the "Venetian blind" mode, the height of the Venetian blind and the slat position can be preset.

The scene function must be enabled on parameter page "Ax – Enabled functions (x = number pair of output).

- Set the parameter "Position ... for scene y" (y = number of the scene (1...8)) on parameter page "Ax – Scenes" for each scene to the desired position (0 %...100 %).

In case of a scene recall, the output is set to the configured position.

- i** The parameterized position values are adopted in the actuator during programming with the ETS only if the parameter "Overwrite values stored in the device during ETS download ?" is set to "yes".
- i** Before approaching the required scene position, the switching / blind actuator performs a reference travel, if the current position data are unknown (e.g. after an ETS programming operation or after switch-on of the supply voltage).

Presetting the storage behaviour for the scene function

The current position value of a Venetian blind, roller shutter, awning, venting louver and also of a slat can be stored internally via the extension object on reception of a scene storage telegram. The position value can be influenced before storage by all functions of the output (e.g. short-time and long-time operation, central or scene recall telegram, safety and sun protection function and manual control).

The scene function must be enabled on parameter page "Ax – Enabled functions (x = number pair of output).

- Set the parameter "Storage function for scene y" (y = number of the scene (1...8)) on parameter page "Ax – Scenes" for each scene to "yes".

The storage function is activated for the scene in question. On reception of a storage telegram via the "Scene extension" object, the current position value will be internally stored.

- Set the parameter "Storage function for scene y" (y = number of the scene (1...8)) on parameter page "Ax – Scenes" for each scene to "no".

The storage function is deactivated for the scene in question. A storage telegram received via the "scene extension" object will be rejected.

- i** The following rules apply for the position data to be stored:
 The current blind, slat and louver positions are stored. With Venetian blinds, the height to be stored is always referred to a slat position of 100 %. Positions temporarily approached will be stored also for those outputs that are involved in a travel movement at the time of data storage.
 On account of the fact that position data is stored as integer percentage values (rounding to 0...100), a minor deviation from the set positions on a later scene recall cannot be avoided.
 The data is only stored if the mains voltage has been available before without interruption for at least 20 seconds after the last reset (storage capacitors sufficiently charged for storage purposes). The data will not be stored, if the position data is unknown.

Setting forced position function (for switching / blind actuator 8/16 gang only available with ETS3.0d and higher).

The forced position function can be enabled for each output. The forced position has the second highest priority after manual control. It therefore overrides the safety function, the sun protection function and the direct operation (short-time, long-time telegram, scenes, positioning, central). During a forced-position state, the output concerned is locked so that it can no longer be controlled with functions of a lower priority, but only with a manual control. At the end of a manual control, the forced-position action is re-executed if the forced position is still active.

The forced position function has a separate 2-bit communication object for each output. The state of the output in case of a forced position function is directly determined by the forced position telegram. The first bit (bit 0) of the "Forced position" object specifies the travel direction to be forced onto the output as in long time operation. The second bit (bit 1) activates or deactivates the forced-position state (cf. table 3).

Bit 1	Bit 0	Function
0	x	Forced position not active normal control
0	x	Forced position not active normal control
1	0	Forced position active, raising / opening the louver
1	1	Forced position active, lowering / closing the louver

Table 3: Bit coding of forced position

The behaviour of an output at the end of the forced-position function can be configured. In addition, the forced object can be initialised on bus voltage return. A mains failure alone (bus voltage present) has no effect on the state of the forced-position object. If only the mains voltage return, a previously activated forced position remains active.

- i** The forced movement time required by an output to move the drive into the end positions is determined by the "Movement time" parameter on parameter page "Ax - Times". Like long time operation, a forced-position movement is derived from the travel time. Downward movement: movement time + 20 %; Upward movement: movement time + 20 % + configured movement time extension. Forced movements are not retriggerable.
- i** The slats of blinds are not repositioned at the end of forced movements into the end positions.
- i** Updates of the forced position object from "forced position active" to "forced position active" while maintaining the forced movement direction or from "forced position inactive" to "forced position inactive" show no reaction.
- i** After programming of the application or of the parameters with the ETS, the forced position is always cancelled.
- i** The forced position function remains active even after a bus voltage failure as long as the mains voltage supply is still on. The forced position function will therefore be executed again at the end of a temporary or permanent manual control – if enabled in case of bus failure – even if there is no bus voltage.
- i** The current state of the forced position function will be stored in case of bus or mains voltage failure.

Enabling the forced position function

The forced position function can be enabled separately for each output.

- Set the parameter "Forced position function" on parameter page "Ax - Enabled functions" (x = number pair of output) to "enabled".

The forced position function is enabled. The corresponding communication object is created and the respective parameters on parameter page "Ax – Forced position" become visible.

Presetting the behaviour at the end of the forced position function

The behaviour of an output at the end of the forced-position function can be parameterized depending on the channel. The behaviour is parameterized on parameter page "Ax – Forced position" (x = number pair of output).

The forced position function of an output must be enabled on parameter page "Ax – Enabled functions" (x = number of output). Only then are the channel-related parameters for the forced position function visible.

- Set the parameter "Behaviour at the end of the forced position function" to "position tracking".

At the end of a forced position function, the output will be set to the state adjusted statically before the forced position function or to the state tracked and internally stored during the forced position function. The position objects, the long time object and the scene function are tracked.

- Set the parameter "Behaviour at the end of the forced position function" to "no change".

At the end of forced position function, the state last adjusted will not be changed. Thereafter, the output is again enabled. Any movements still in progress at this instant will still be finished.

- i** Parameter setting "Position tracking": The switching / blind actuator can track absolute positions (position telegram, scene value) during activated forced control only if the position data are known and if positions have been predefined. If this is not the case, no reaction takes place at the time forced control is enabled.
Position data can be tracked, if the output has been in a defined position before the forced position function or if a new position telegram has been received via the position objects while the forced position function was interlocked. In the latter case, a reference movement will be executed when the forced position function is enabled, if the position was unknown before or during the safety interlock.
Known slat positions will also be tracked as described. This is also the case, when the height of the Venetian blind is unknown.
Long time movements (movements without position preset) will, however, always be tracked.
- i** The preset "Behaviour at the end of the forced position function" will only be executed, if the output passes over to direct operation at the end of the forced position function. If a safety function or a sun protection function is activated (independent of the preset priority with respect to direct operation), the function with the next lower priority will be executed. The configured behaviour is not executed when the forced position is terminated by a specification on bus voltage return. In this case the parameter "Behaviour after bus/mains voltage return" will be evaluated.

Presetting the behaviour of the forced position function after bus voltage return

The forced position communication object can be initialised after bus voltage return. In this way, an output can be influenced and locked on bus initialisation when the forced position function is being activated.

A mains failure alone has no effect on the forced position. If only the mains voltage return, a previously activated forced position remains active.

The behaviour of the forced position after bus voltage return is configured separately for each output on the parameter pages "Ax – Forced position" (x = number pair of output).

Depending on the selected operating mode, the ETS adapts the designations of the parameter settings ("raising" ↔ "opening the louver" / "lowering" ↔ "closing the louver").

After bus voltage return, the configured state is transferred to the "Forced position" communication object.

The forced position function of an output must be enabled on parameter page "Ax – Enabled functions (x = number of output)". Only then are the channel-related parameters for the forced position function visible.

- Set the parameter "Behaviour after bus voltage return" to "no forced position active".
The forced position is deactivated after bus voltage return. In this case, the set parameter "Behaviour after bus/mains voltage return" will be evaluated for bus voltage return.
- Set the parameter "Behaviour after bus voltage return" to "forced position function ON, raising" or "forced position function ON, opening the louver".
After bus voltage return, the forced position is activated and the blind raised or the venting louver opened. The output concerned is interlocked by forced control until an enable signal is received via the bus. The parameter "Behaviour after bus/mains voltage return" will in this case not be evaluated for the output concerned.
- Set the parameter "Behaviour after bus voltage return" to "forced position function ON, lowering" or "forced position function ON, closing the louver".
After bus voltage return, the forced position is activated and the blind lowered or the venting louver closed. The output concerned is interlocked by forced control until an enable signal is received via the bus. The parameter "Behaviour after bus/mains voltage return" will in this case not be evaluated for the output concerned.
- Set the parameter "Behaviour after bus voltage return" to "state of forced position before bus/mains failure".

After bus voltage return, the forced-position state last selected and internally stored before bus or mains voltage failure will be tracked. An ETS programming operation deletes the stored state (reaction in that case same as with "no forced position active"). If the tracked state corresponds to "no forced position active", the parameter "Behaviour after bus/mains voltage return" will be executed on return of bus voltage.

- i** Setting or tracked state "no forced position active": The reaction of the output concerned after return of bus voltage is defined by the parameter "Behaviour after bus/mains voltage return".
- i** After programming of the application or of the parameters with the ETS, the forced position is always cancelled.

'Fabric-stretching' function

In the roller shutter/awning operating mode, the fabric stretching function can be activated. The fabric stretching function permits 'smoothing' the fabric of an awning tight after lowering. The fabric stretching function can also be used with roller shutters to reopen the slits of the shutter curtain after a downward movement into the lower end position.

If activated in the ETS parameters, fabric stretching is executed during each downward movement after stopping and after the configured switchover delay has elapsed. The curtain is then 'stretched' by moving briefly into the opposite movement direction (figure 45).

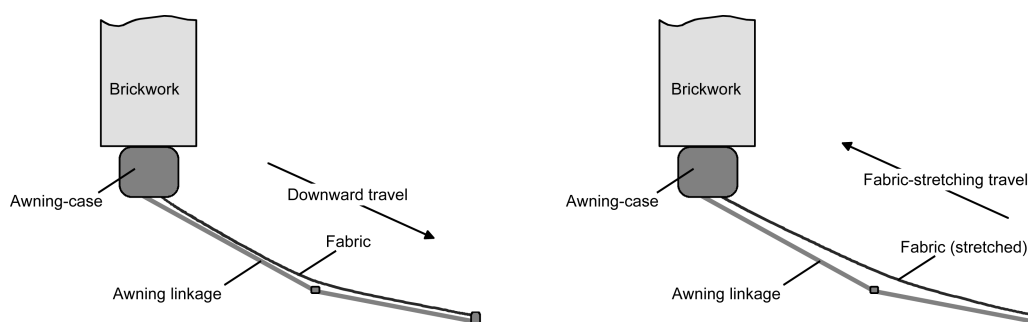

Figure 45: Fabric stretching in an awning

The downward travel can be triggered by any of the following events: Long-time, short-time or position telegram, forced position, safety or sun protection function, central telegram or scene recall and also the manual control.

Fabric stretching is never effected in upward movements.

- i** Fabric stretching affects the determination of positions and the position feedback since a fabric stretching movement changes the position of a shutter or an awning. In a positioning move into the lower end position (100 %), the position value reported back after the fabric stretching operation will always be a smaller one.
- i** Fabric stretching cannot be configured in the Venetian blind or louver modes of operation.

Activating fabric-stretching function

The fabric-stretching function can be activated independently for each shutter or awning output on parameter page "Ax – Enabled functions" (x = number pair of output).

The operating mode selected must be the "Roller shutter/awning" mode.

- Set the parameter "Fabric stretching function" to "enabled".

Parameter page "Ax – Fabric-stretching" is enabled and the fabric-stretching function is activated.

- i** Fabric stretching cannot be configured in the Venetian blind or louver modes of operation.

Setting fabric-stretching function

An activated fabric-stretching function can be activated independently for each shutter or awning output on parameter page "Ax – fabric-stretching" (x = number pair of output). The movement time required for fabric stretching by means of a movement in opposite direction can be configured.

The fabric stretching function has to be activated.

- Select the desired value for the "Time for fabric stretching" parameter.

After the end of a downward movement the blind stops and – after the switchover delay has elapsed – moves backwards in opposite direction for a period corresponding to the configured fabric stretching time.

- i** Set the time for fabric stretching to less than the configured or measured movement time of the roller shutter or awning. Otherwise, there is the risk of malfunction.
- i** Fabric stretching will only be effected if the downward movement lasts longer than the configured fabric stretching time.

4.2.4.3 Delivery state

In the state as delivered, the actuator is passive, i.e. no telegrams are transmitted to the bus. The outputs can, however, be operated by manual control on the device, if the mains voltage is on. In the manual control mode, no feedback telegrams are sent to the bus. Other functions of the actuator are deactivated.

The device can be programmed and put into operation via the ETS. The physical address is preset to 15.15.255

Moreover the device has been configured at the factory with the following characteristics...

- Channel definition: all outputs configured to blinds operation
- Movement time (continuous run): 1 minute
- Movement time extension: 2 %
- Break during movement direction changeover: 1 s
- Behaviour in case of bus voltage failure: no reaction
- Behaviour after bus or mains voltage return: Stop

4.2.5 Parameters

Description	Values	Comment
□ General		
Delay after bus voltage return Minutes (0...59)	0...59	To reduce telegram traffic on the bus line after bus voltage activation (bus reset), after connection of the device to the bus line or after programming with the ETS, it is possible to delay all active feedback telegrams of the actuator. The parameter specifies in this case a delay valid for all devices. Only after the time configured here has elapsed are feedback telegrams for initialisation transmitted to the bus. Setting the delay time minutes.
Seconds (0...59)	0...17...59	Setting the delay time seconds.
Central function for switching outputs ?	Yes No	Setting "Yes" enables the central function for the switching outputs and thus the "Central switching" object. An assignment of individual switching outputs to the central function is only possible if the function is enabled.
Central object polarity	0 = switch off; 1 = switch on 0 = switch on; 1 = switch off	This parameter defines the polarity of the "central switching" central object. i This parameter is visible only if the central switching function is enabled.
Central function for blind outputs ?	Yes No	Setting "yes" enables the central function for the venetian blind outputs and thus the "Central travel control" object. An assignment of individual venetian blind outputs to the central function is only possible if the function is enabled.
Central object polarity	0 = UP; 1 = DOWN 0 = DOWN; 1 = UP	This parameter defines the polarity of the central object. i This parameter is visible only if the venetian blind central function is enabled.
Use collective feedback for switching outputs ?	No Yes, active signalling object Yes, passive status object	To keep the telegram load low during 'bus initialisation', collective feedback of the actuator can be used. Setting "Yes" activates the collective feedback for the objects in the switching operation and enables the corresponding object. The parameter moreover defines whether the feedback telegrams are transmitted actively (telegram transmission in case of changes) or passively (telegram transmission only as a response to a 'Read' request). The communication flags of the object are automatically set by the ETS according to the setting.

<p>Time delay for feedback telegram after bus voltage return ?</p>	<p>Yes No</p>	<p>The collective feedback telegram can be transmitted to the bus with a delay after bus voltage return or after programming with the ETS. Setting "Yes" activates the delay time of the collective feedback in case of bus voltage return. The delay time is parameterized under "General" (see above).</p> <p>i This parameter is visible only if collective feedback is enabled.</p>
<p>Cyclic transmission of the collective feedback ?</p>	<p>Yes (transmission cyclically and when change)</p> <p>No (transmission only when change)</p>	<p>The object value of the collective feedback can be transmitted cyclically.</p> <p>The feedback telegram is transmitted to the bus cyclically and when there is a change of state. The cycle time is parameterised generally under "switching outputs times" for all feedback telegrams.</p> <p>The feedback telegram is transmitted to the bus only when there is a change of state.</p> <p>i This parameter is visible only if collective feedback is enabled.</p>
<p>Blinking rate (all assigned switching outputs)</p>	<p>1 sec 2 sec 5 sec 10 sec</p>	<p>Switching operations can also be configured as "flashing" at the beginning or at the end of a disabling function, if used. In this case, outputs change their switching state cyclically.</p> <p>The parameter "flashing rate" generally defines the switch-on time and switch-off time of a flashing output signal for all switching outputs.</p> <p>Example: Blinking rate = 1 s 1 sec. on -> 1 sec. off -> 1 sec. on -> 1 sec off ...</p>
<p><input type="checkbox"/> Switching outputs times</p> <p>Time for cycl. transmission of feedback Hours (0...23)</p>	<p>0...23</p>	<p>The different active transmitting feedback telegrams of the actuator can, depending on the parameterisation, also transmit their state cyclically to the bus. The parameter "Time for cyclical transmission of feedback tel." generally defines the cycle time for all outputs.</p> <p>Sets the cycle time hours.</p>

Minutes (0...59)	0... 2 ...59	Sets the cycle time minutes.
Seconds (10...59)	10 ...59	Sets the cycle time seconds.
<i>Presetting: 2 minutes 10 seconds</i>		
<input type="checkbox"/> Venetian blind outputs safety		
Safety functions	disabled enabled	If it is intended to make use of the 5 safety functions of the actuator and to parameterize them, the function must be enabled for all channels (setting: "enabled"). If the safety functions are deactivated (setting: "disabled"), any programmed assignment of individual shutter outputs to safety monitoring functions is not operational.
Wind alarm 1	disabled enabled	This parameter can be used to enable the first wind alarm and thus to enable the communication object (setting: "enabled"). If the first wind alarm is deactivated (setting: "disabled"), any programmed assignment of individual shutter outputs to wind alarm 1 is not operational.
Wind alarm 2	disabled enabled	This parameter can be used to enable the second wind alarm and thus to enable the communication object (setting: "enabled"). If the first wind alarm is deactivated (setting: "disabled"), any programmed assignment of individual shutter outputs to wind alarm 2 is not operational.
Wind alarm 3	disabled enabled	This parameter can be used to enable the third wind alarm and thus to enable the communication object (setting: "enabled"). If the third wind alarm is deactivated (setting: "disabled"), any programmed assignment of individual shutter outputs to wind alarm 3 is not operational.
Rain alarm	disabled enabled	This parameter can be used to enable the rain alarm and thus to enable the communication object (setting: "enabled"). If the rain alarm is deactivated (setting: "disabled"), any programmed assignment of individual shutter outputs to the rain alarm is not operational.
Frost alarm	disabled enabled	This parameter can be used to enable the frost alarm and thus to enable the communication object (setting: "enabled"). If the frost alarm is deactivated (setting: "disabled"), any programmed assignment of individual shutter outputs to the frost alarm is not operational.

Priority of safety alarms

			<ul style="list-style-type: none"> i As soon as the monitoring function is activated, telegrams must be transmitted cyclically to the enabled rain alarm object. i The parameter is only visible, if the rain alarm has been enabled under "Safety".
Time for monitoring rain alarm	0...23		The rain alarm monitoring time is configured here.
Hours (0...23)			Sets the monitoring time hours.
Minutes (1...59)	1...2...59		Sets the monitoring time minutes.
			<i>Presetting: 2 minutes</i>
			<ul style="list-style-type: none"> i The cycle time of the transmitter should be less than half the parameterized monitoring time of the actuator. i The times can only be set if rain alarm monitoring is activated.
Use frost alarm monitoring function ?	Yes		If the frost alarm enabled under "Venetian blinds output safety" is to be monitored cyclically for incoming telegrams to the safety object, the monitoring function must be enabled here (setting: "yes").
	No		Otherwise (setting: "No") there is no cyclical monitoring of the object.
			<ul style="list-style-type: none"> i As soon as the monitoring function is activated, telegrams must be transmitted cyclically to the enabled frost alarm object. i The parameter is only visible, if the frost alarm has been enabled under "Venetian blinds output safety".
Time for monitoring frost alarm	0...23		The frost alarm monitoring time is configured here.
Hours (0...23)			Sets the monitoring time hours.
Minutes (1...59)	1...2...59		Sets the monitoring time minutes.
			<i>Presetting: 2 minutes</i>
			<ul style="list-style-type: none"> i The cycle time of the transmitter should be less than half the parameterized monitoring time of the actuator. i The times can only be set, if frost alarm monitoring is activated.

Manual operation

Manual control in case of bus voltage failure	Disabled	This parameter can be used for programming whether manual control is to be possible (enabled) or deactivated in case of bus voltage failure.
	Enabled	
Manual control during bus operation	Disabled	This parameter can be used for programming whether manual control is to be possible (enabled) or deactivated during bus operation (bus voltage on).
	Enabled	
Disabling function ?	Yes	Manual control can be disabled via the bus, even if it is already active. For this purpose, the disabling object can be enabled here.
	No	
Polarity of disable object	0 = enabled; 1 = disabled	This parameter sets the polarity of the disabling object. i Only visible if the disabling function for manual control is enabled.
	0 = disabled; 1 = enabled	
Transmit status ?	Yes	The current state of manual control can be transmitted to the bus via a separate status object, if bus voltage is available (setting: "Yes").
	No	
Status object function and polarity		This parameter defines the information contained in the status object. The object is always "0", when the manual control mode is deactivated.
	0 = inactive; 1 = manual control active	The object is "1" when the manual control mode is active (temporary or permanent).
	0 = inactive; 1 = permanent manual control active	The object is "1" only when the permanent manual control is active. i This parameter is visible only if the manual control status transmission is enabled.
		i After bus voltage return, the status will only be transmitted actively to the bus ("0") if a manual control was ended by the bus return.
Behaviour at the end of permanent manual control during bus operation		The behaviour of the actuator at the end of permanent manual control depends on this parameter. All telegrams received during an active permanent manual control mode for direct operation (switching, long-time/short-time, positioning, scenes) are rejected. After the end of the permanent manual control mode, the current state of all outputs remains unchanged. If, however, a function with a higher priority was activated as direct operation during manual operation (safety, forced position, sun protection), the actuator
	No change	

	output tracking	activates the higher-ranking function for the corresponding outputs. During an active permanent manual control all incoming telegrams (short-time telegrams excepted) are internally tracked. At the end of manual control, the outputs are adjusted accordingly.
Disable bus control of individual outputs during bus operation	Yes No	Individual outputs can be disabled locally during permanent manual control, so that the disabled outputs can no longer be controlled via the bus. Disabling via manual control is only permitted if this parameter is set to "Yes".
<input type="checkbox"/> Select Switching - shutter/blind		
Function Output 1 and output 2	1 x blind output 2 x switching output	This parameter defines the channel definition of the output pair A1 and A2.
Function Output 3 and output 4	1 x blind output 2 x switching output	This parameter defines the channel definition of the output pair A3 and A4.
Function Output 5 and output 6*	1 x blind output 2 x switching output	This parameter defines the channel definition of the output pair A5 and A6.
Function Output 7 and output 8*	1 x blind output 2 x switching output	This parameter defines the channel definition of the output pair A7 and A8.
Function Output 9 and output 10**	1 x blind output 2 x switching output	This parameter defines the channel definition of the output pair A9 and A10.
Function Output 11 and output 12**	1 x blind output 2 x switching output	This parameter defines the channel definition of the output pair A11 and A12.
Function Output 13 and output 14**	1 x blind output 2 x switching output	This parameter defines the channel definition of the output pair A13 and A14.
Function Output 15 and output 16**	1 x blind output 2 x switching output	This parameter defines the channel definition of the output pair A15 and A16.

*: Only for switching / blind actuator 4/8gang

& 8/16gang.

** : Only for switching / blind actuator 8/16gang

☐ Ax – General (x = number of output pair 1/2 ... max. 15/16 In blinds operation / All outputs can be parameterized independent of one another. / Only visible In blinds operation!)

Operating mode
(Please set first!)

Venetian blind

Roller shutter / awning

Venting louver

The switching / blind actuator can control various drive systems in blinds operation. This parameter defines which type of drive or which type of curtain is connected to the output.

i The ETS adapts all of the following parameters (designations, visible/non visible, etc.) dynamically to the respective "operating mode" parameter. For this reason, the "Operating mode" parameter should be adjusted before all other parameters of an output.

Behaviour after ETS programming

The actuator permits setting the preferred relay contact position after ETS programming separately for each output.

Raising / opening the louvre

After programming with the ETS, the actuator raises the blind or opens the venting louvre.

Lowering / closing the louvre

After programming with the ETS, the actuator lowers the blind or closes the venting louvre.

stop

After programming with the ETS, the actuator switches the relays of the output to the "stop" position. A drive movement, if any, will be interrupted.

i The configured behaviour will be executed after every application or parameter download by the ETS. A simple download of the physical address alone or partial programming of only the group addresses has the effect that this parameter is disregarded and that the configured "Behaviour after bus voltage return" will be executed instead.

Behaviour in case of bus voltage failure

The actuator permits setting the preferred relay contact position in case of bus voltage failure separately for each output.

stop

In case of bus voltage failure, the actuator switches the relays of the output to the "stop" position. A drive movement, if any, will be interrupted.

	Raising / opening the louvre	After bus voltage failure, the actuator raises the blind or opens the venting louvre.
	Lowering / closing the louvre	After bus voltage failure, the actuator lowers the blind or closes the venting louvre.
	Approaching a position	In case of bus voltage failure, the connected drive can approach a position specified by further parameters.
	No reaction	In the event of bus voltage failure, the relay of the output shows no reaction. Any drive movements still in progress at the time of failure will be completely finished.
Position of Venetian blind in case of bus voltage failure (0...100%)	0...100%	<p>This parameter specifies the Venetian blind position to be approached in case of bus voltage failure.</p> <ul style="list-style-type: none"> i This parameter is only visible, if "Behaviour in case of bus voltage failure" is set to "approach position". i This parameter is only visible in the Venetian blind operating mode.
Position of slat in case of bus voltage failure (0...100%)	0...100%	<p>This parameter specifies the slat position to be approached in case of bus voltage failure after the Venetian blind has been positioned at the desired height.</p> <ul style="list-style-type: none"> i This parameter is only visible, if "Behaviour in case of bus voltage failure" is set to "approach position". i This parameter is only visible in the Venetian blind operating mode.
Position of roller shutter/awning in case of bus voltage failure (0...100%)	0...100%	<p>This parameter specifies the roller shutter or awning position to be approached in case of bus voltage failure.</p> <ul style="list-style-type: none"> i This parameter is only visible, if "Behaviour in case of bus voltage failure" is set to "approach position". i This parameter is only visible in the roller shutter/awning operating mode.
Position of venting louvre in case of bus voltage failure (0...100%)	0...100%	<p>This parameter specifies the venting louvre position to be approached in case of bus voltage failure.</p>

Behaviour after bus or
mains voltage return

stop

Raising / opening the
louvre

Lowering / closing the
louvre

Position during bus/sup.
vltg. failure

Approaching a position

No reaction

- i This parameter is only visible, if "Behaviour in case of bus voltage failure" is set to "approach position".
- i This parameter is visible only in the 'Venting louvre' operating mode.

The actuator permits setting the preferred relay contact position after mains voltage return separately for each output. This means that the configured behaviour is executed when either the bus or the mains voltage is switched on again.

In case of bus or mains voltage return, the actuator switches the relays of the output to the "stop" position. A drive movement, if any, will be interrupted.

After bus or mains voltage return, the actuator raises the curtain or opens the venting louvre.

After bus or mains voltage return, the actuator lowers the curtain or closes the venting louvre.

After bus or mains voltage return, the state last existing and internally stored before bus or mains voltage failure will be tracked.

On bus or mains voltage return, the connected drive can travel to a position specified by other parameters.

In the event of bus or mains voltage return, the relay of the output shows no reaction. Any movements still in progress will be finished at the instant when voltage returns.

The commands received via the bus at the time when only a mains voltage fails, are tracked after the mains voltage returns.

Interrupted short or long time travel movements are restarted at full length and position approaches are continued from the point of interruption.

- i The device adopts the parameterized behaviour only if the last ETS programming of the application or of the parameters ended at least ca. 20 s ago. Otherwise ($T_{ETS} < 20$ s), the "Behaviour after ETS programming" will be adopted also in case of mains voltage return.

Venetian blind position **0...100%**
on bus/mains voltage

return
(0...100%)

This parameter specifies the Venetian blind position to be approached in case of bus or mains voltage return.

- This parameter is only visible, if "Behaviour in case of bus or mains-voltage return" is set to "approach position".
- This parameter is only visible in the Venetian blind operating mode.

Slat position on bus/
mains voltage return
(0...100%)

This parameter specifies the slat position to be approached in case of bus or mains voltage return after the Venetian blind has been positioned at the desired height.

- This parameter is only visible, if "Behaviour in case of bus or mains-voltage return" is set to "approach position".
- This parameter is only visible in the Venetian blind operating mode.

Roller shutter/awning
position on bus/mains
voltage return
(0...100%)

This parameter specifies the roller shutter or awning position to be approached in case of bus or mains voltage return.

- This parameter is only visible, if "Behaviour in case of bus or mains-voltage return" is set to "approach position".
- This parameter is only visible in the roller shutter/awning operating mode.

Position of venting
louvre on return of bus/
mains voltage
(0...100%)

This parameter specifies the venting louvre position to be approached in case of bus or mains voltage return.

- This parameter is only visible, if "Behaviour in case of bus or mains-voltage return" is set to "approach position".
- This parameter is visible only in the 'Venting louvre' operating mode.

Travelling time
extension for upward
travel

2 %
3 %
4 %
5 %
6 %
7 %
8 %
9 %

The switching / blind actuator extends all the up movements or all venting louver movements into the opened position of venetian blind outputs using the extension configured here. The time extension expressed in percent is the difference between the measured travel time needed to reach the lower end position (completely closed position) and

	10 % 12.5 %	the time needed to reach the upper end position (completely open position).
<p>☐ Ax – Times (x = number of output pair 1/2 ... max. 15/16 In blinds operation / All outputs can be parameterized independent of one another. / Only visible In blinds operation!)</p>		
Short time operation		This parameter can be used to configure the reaction to a received short time telegram.
	No (only stop)	The drive will only be stopped if it is executing a movement at the time of telegram reception. There is no reaction if no movement is in progress.
	Yes	Short-time operation is started on reception of a short-time telegram when the drive is stationary. If the drive is in motion at the time of telegram reception, it will be stopped.
Time for short time operation Seconds (0...59)	0...59	This parameter defines the duration of short-time operation.
Milliseconds (0...99 x 10)	0...50...99	Sets the monitoring time seconds. Sets the monitoring time milliseconds. <i>Presetting: 500 milliseconds</i>
		<p>i The duration of short time operation should in no case exceed half the slat adjusting time.</p> <p>i This parameter is only visible, if the parameter "Short-time operation" is set to "yes".</p>
Venetian blind travelling time Minutes (0...59)	0...1...59	This parameter defines the travelling time of the Venetian blind. The time needed for a complete travel from the upper into the lower end position must be determined.
Seconds (0...59)	0...59	Sets the minutes of the Venetian blind travelling time. Sets the seconds of the Venetian blind travelling time. <i>Presetting: 1 minute</i>
		<p>i The travelling time must be determined precisely.</p> <p>i These parameters are visible only in the 'Blind' mode of operation.</p>
Roller shutter/awning travelling time Minutes (0...59)	0...1...59	This parameter defines the travelling time of the roller shutter or awning. The time needed for a complete travel from the upper into the lower end position

			must be determined.
			Sets the minutes of the roller shutter/ awning moving time.
Seconds (0...59)	0...59		Sets the seconds of the roller shutter/ awning moving time.
			<i>Presetting: 1 minute</i>
			<input type="checkbox"/> The travelling time must be determined precisely.
			<input type="checkbox"/> These parameter are visible only in the "Roller Shutter / Awning" operating mode.
Venting louver travelling time Minutes (0...59)	0...1...59		This parameter defines the travelling time of the venting louver. The time needed for a complete travel from the completely open into the completely closed position must be determined.
			Sets the minutes of the venting louver travelling time.
Seconds (0...59)	0...59		Sets the seconds of the venting louver travelling time.
			<i>Presetting: 1 minute</i>
			<input type="checkbox"/> The travelling time must be determined precisely.
			<input type="checkbox"/> These parameters are visible only in the 'Venting louver' mode of operation.
Slat travelling time Minutes (0...59)	0...59		This parameter defines the travelling time of the slats. The time needed for a complete movement from the completely open slat position into the completely closed slat position (downward direction) must be determined.
			Sets the minutes of the slat moving time.
Seconds (0...59)	0...4...59		Sets the seconds of the slat moving time.
			<i>Presetting: 4 seconds</i>
			<input type="checkbox"/> The travelling time must be determined precisely.
			<input type="checkbox"/> The slat moving time must be selected shorter than the blind travelling time.
			<input type="checkbox"/> These parameters are visible only in the 'Blind' mode of operation.

Change-over time for travel direction changes	0.5 s 1 s 2 s 5 s	Defines the pause for a travel direction change (change-over time).
<p>☐ Ax – Enabled functions (x = number of output pair 1/2 ... max. 15/16 In blinds operation / All outputs can be parameterized independent of one another. / Only visible In blinds operation!)</p>		
Feedback functions	disabled Enabled	This parameter can be used to disable or to enable the feedback functions. When the function is enabled, the required parameters will be displayed under "Ax –Feedbacks".
Safety functions	disabled Enabled	This parameter can be used disable or to enable the safety functions. When the function is enabled, the corresponding parameters will be displayed under "Ax - Safety" and the necessary object enabled.
Sun protection functions	disabled Enabled	This parameter can be used disable or to enable the sun protection functions. When the function is enabled, the corresponding parameters will be displayed under "Ax Sun protection" (3 parameter nodes) and the necessary objects enabled.
Light scene function (For actuator 8/16 gang only available with ETS3.0d and higher)	disabled Enabled	This parameter can be used disable or to enable the scene function. When the function is enabled, the corresponding parameters will be displayed under "Ax Scenes" and the necessary object enabled.
Forced position function (For actuator 8/16 gang only available with ETS3.0d and higher)	disabled Enabled	This parameter can be used to disable or to enable the forced position function. When the function is enabled, the corresponding parameters will be displayed under "Ax - Forced position" and the necessary object enabled.
Fabric-stretching function	disabled Enabled	This parameter can be used disable or to enable the fabric-stretching function. When the function is enabled, the corresponding parameters will be displayed under "Ax Fabric-stretching" and the necessary object enabled.
Assignment to central function ?	Yes (enable central function under "General!")	<p>i This parameter is only visible in the roller shutter/awning operating mode.</p> <p>This parameter determines the assignment of the output to the central function.</p> <p>The output is assigned to the central function. The venetian blind central function is supposed to have been enabled under "General". The assignment has otherwise no effect on the Venetian blind output.</p>

	No	The output is not assigned to the central function.
<p>☐ Ax – Feedbacks (x = number of output pair 1/2 ... max. 15/16 In blinds operation / All outputs can be parameterized independent of one another. / Only visible in blinds operation and only accessible if parameter "Feedback functions ?" under "Ax – Enabled functions" is set to "enabled"!)</p>		
Venetian blind position feedback		The current Venetian blind position of the output can be reported separately back to the bus.
	no feedback	No feedback object available for the output. Feedback deactivated.
	Feedback object is active signalling object	Feedback and the object are activated. The object transmits actively (telegram transmission after change).
	Feedback object is passive status object	Feedback and the object are activated. The object is passive (telegram transmission only as a response to 'Read' request).
		<ul style="list-style-type: none"> ☐ The communication flags of the object are automatically set by the ETS according to the setting. ☐ This parameter is only visible in the Venetian blind operating mode.
Roller shutter/awning position feedback		The current roller shutter or awning position of the output can be reported separately back to the bus.
	no feedback	No feedback object available for the output. Feedback deactivated.
	Feedback object is active signalling object	Feedback and the object are activated. The object transmits actively (telegram transmission after change).
	Feedback object is passive status object	Feedback and the object are activated. The object is passive (telegram transmission only as a response to 'Read' request).
		<ul style="list-style-type: none"> ☐ The communication flags of the object are automatically set by the ETS according to the setting. ☐ This parameter is only visible in the roller shutter/awning operating mode.
Venting louvre position feedback		The current venting louvre position of the output can be reported separately back to the bus.
	no feedback	No feedback object available for the output. Feedback deactivated.
	Feedback object is active signalling object	Feedback and the object are activated. The object transmits actively (telegram transmission after change).

	Feedback object is passive status object	Feedback and the object are activated. The object is passive (telegram transmission only as a response to 'Read' request).
		<ul style="list-style-type: none"> i The communication flags of the object are automatically set by the ETS according to the setting. i This parameter is visible only in the 'Venting louver' operating mode.
Time delay for feedback after bus voltage return ?	<p>Yes (delay time under "General!")</p> <p>No</p>	<p>The feedback telegram can be transmitted to the bus with a delay after bus voltage return or after programming with the ETS. Setting "Yes" activates the delay time of the feedback in case of bus voltage return. The delay time is configured under "General".</p> <ul style="list-style-type: none"> i This parameter is only visible in case of an actively transmitting feedback object.
Slat position feedback	no feedback	<p>The current slat position of the output can be reported separately back to the bus.</p> <p>No feedback object available for the output. Feedback deactivated.</p>
	Feedback object is active signalling object	Feedback and the object are activated. The object transmits actively (telegram transmission after change).
	Feedback object is passive status object	Feedback and the object are activated. The object is passive (telegram transmission only as a response to 'Read' request).
		<ul style="list-style-type: none"> i The communication flags of the object are automatically set by the ETS according to the setting. i This parameter is only visible in the Venetian blind operating mode.
Time delay for feedback after bus voltage return ?	<p>Yes (delay time under "General!")</p> <p>No</p>	<p>The feedback telegram can be transmitted to the bus with a delay after bus voltage return or after programming with the ETS. Setting "Yes" activates the delay time of the feedback in case of bus voltage return. The delay time is configured under "General".</p> <ul style="list-style-type: none"> i This parameter is only visible in case of an actively transmitting feedback object.
Invalid Venetian blind position feedback	no feedback	<p>The actuator can report to the bus that the current blind position is unknown (e.g. after an initialisation, when no reference travel has been executed as yet).</p> <p>No feedback object available for the output. Feedback deactivated.</p>

	Feedback object is active signalling object	Feedback and the object are activated. The object transmits actively (telegram transmission after change).
	Feedback object is passive status object	Feedback and the object are activated. The object is passive (telegram transmission only as a response to 'Read' request). <ul style="list-style-type: none"> i The communication flags of the object are automatically set by the ETS according to the setting. i This parameter is only visible in the Venetian blind operating mode.
Invalid roller shutter/ awning position feedback	no feedback	The actuator can report to the bus that the current roller shutter/awning position is unknown (e.g. after an initialisation, when no reference travel has been executed as yet). No feedback object available for the output. Feedback deactivated.
	Feedback object is active signalling object	Feedback and the object are activated. The object transmits actively (telegram transmission after change).
	Feedback object is passive status object	Feedback and the object are activated. The object is passive (telegram transmission only as a response to 'Read' request). <ul style="list-style-type: none"> i The communication flags of the object are automatically set by the ETS according to the setting. i This parameter is only visible in the roller shutter/awning operating mode.
Invalid venting louvre position feedback	no feedback	The actuator can report to the bus that the current venting louvre position is unknown (e.g. after an initialisation, when no reference travel has been executed as yet). No feedback object available for the output. Feedback deactivated.
	Feedback object is active signalling object	Feedback and the object are activated. The object transmits actively (telegram transmission after change).
	Feedback object is passive status object	Feedback and the object are activated. The object is passive (telegram transmission only as a response to 'Read' request). <ul style="list-style-type: none"> i The communication flags of the object are automatically set by the ETS according to the setting. i This parameter is visible only in the 'Venting louvre' operating mode.
	Yes (delay time under "General"!)	The feedback telegram can be transmitted to the bus with a delay after

Time delay for feedback after bus voltage return ?	No	<p>bus voltage return or after programming with the ETS. Setting "Yes" activates the delay time of the feedback in case of bus voltage return. The delay time is configured under "General".</p> <p>i This parameter is only visible in case of an actively transmitting feedback object.</p>
Drive movement feedback	no feedback	<p>The actuator can report to the bus that the connected drive is active, i.e. the output is supplying power to the drive for a travel direction.</p> <p>No feedback object available for the output. Feedback deactivated.</p>
	Feedback object is active signalling object	<p>Feedback and the object are activated. The object transmits actively (telegram transmission after change).</p>
	Feedback object is passive status object	<p>Feedback and the object are activated. The object is passive (telegram transmission only as a response to 'Read' request).</p> <p>i The communication flags of the object are automatically set by the ETS according to the setting.</p>
Time delay for feedback after bus voltage return ?	<p>Yes (delay time under "General!")</p> <p>No</p>	<p>The feedback telegram can be transmitted to the bus with a delay after bus voltage return or after programming with the ETS. Setting "Yes" activates the delay time of the feedback in case of bus voltage return. The delay time is configured under "General".</p> <p>i This parameter is only visible in case of an actively transmitting feedback object.</p>
<p>☐ Ax – Safety (x = number of output pair 1/2 ... max. 15/16 In blinds operation / All outputs can be parameterized independent of one another. / Only visible in blinds operation and only accessible if parameter "Safety functions ?" under "Ax – Enabled functions" is set to "enabled"!)</p>		
Assignment to wind alarms	No	<p>This parameter defines whether the output responds to a wind alarm and to which of the alarms.</p>
	Wind alarm 1	
	Wind alarm 2	
	Wind alarm 3	
	Wind alarm 1 + 2	
	Wind alarm 1 + 3	
	Wind alarm 2 + 3	
	Wind alarm 1 + 2 + 3	
Behaviour in case of wind alarm		

		<p>This parameter defines the behaviour of the output at the beginning of a wind alarm.</p>
	No reaction	<p>At the beginning of the wind alarm or wind alarms, the output is interlocked and the relay of the output shows no reaction. Any movements in progress at this instant will still be completely finished.</p>
	Raising / opening the louvre	<p>The actuator raises the curtain or opens the venting louver at the beginning of the wind alarm or wind alarms and locks the output thereafter.</p>
	Lowering / closing the louvre	<p>The actuator lowers the curtain or closes the venting louver at the beginning of the wind alarm or wind alarms and locks the output thereafter.</p>
	stop	<p>At the beginning of the wind alarm or wind alarms, the actuator switches the relays of the output to "stop" and locks the output. A drive movement, if any, will be interrupted.</p> <p>i The behaviour preset in this parameter will be executed when one of the assigned wind alarms is activated.</p> <p>i This parameter is only visible if the output has been assigned to at least one wind alarm.</p>
Assignment to rain alarm	Yes	<p>This parameter defines whether the output responds to the rain alarm.</p>
	No	
Behaviour in case of rain alarm		<p>This parameter defines the behaviour of the output at the beginning of the rain alarm.</p>
	No reaction	<p>At the beginning of the rain alarm, the output is locked and the relay of the output shows no reaction. Any movements in progress at this instant will still be completely finished.</p>
	Raising / opening the louvre	<p>The actuator raises the curtain or opens the venting louver at the beginning of the rain alarm and locks the output thereafter.</p>
	Lowering / closing the louvre	<p>The actuator lowers the curtain or closes the venting louver at the beginning of the rain alarm and locks the output thereafter.</p>
	stop	<p>At the beginning of the rain alarm, the actuator switches the relays of the output to "stop" and locks the output. A</p>

		drive movement, if any, will be interrupted.
		i This parameter is only visible, if the output has been assigned to the rain alarm.
Assignment to frost alarm	Yes	This parameter defines whether the output responds to the frost alarm.
	No	
Behaviour in case of frost alarm	No reaction	i An assignment to the alarms is only possible if the safety functions and the alarms themselves are enabled under "Safety". This parameter defines the behaviour of the output at the beginning of the frost alarm. At the beginning of the frost alarm, the output is interlocked and the relay of the output shows no reaction. Any movements in progress at this instant will still be completely finished.
	Raising / opening the louvre	The actuator raises the curtain or opens the venting louver at the beginning of the frost alarm and locks the output thereafter.
	Lowering / closing the louvre	The actuator lowers the curtain or closes the venting louver at the beginning of the frost alarm and locks the output thereafter.
	stop	At the beginning of the frost alarm, the actuator switches the relays of the output to "stop" and locks the output. A drive movement, if any, will be interrupted.
		i This parameter is only visible, if the output has been assigned to the frost alarm.
Behaviour at the end of safety (Wind, rain, frost)	No reaction	This parameter defines the behaviour of the output at the end of all safety functions. At the end of the safety functions, the output is unlocked and the relay of the output shows no reaction. Any movements still in progress at this instant will still be finished.
	Raising / opening the louvre	The actuator unlocks the output at the end of all safety alarms and raises the curtain or opens the venting louver.
	Lowering / closing the louvre	

<p>stop</p>	<p>The actuator unlocks the output at the end of the safety functions and lowers the curtain or closes the venting louver.</p>
<p>Tracking the position</p>	<p>At the end of the safety functions, the output is unlocked and the actuator switches the relays of the output into the "stop" position. A drive movement, if any, will be interrupted.</p> <p>At the end of safety, the output will be set to the state last adjusted before the safety function or to the state tracked and internally stored during the safety function. The position objects, the long time object and the scene function are tracked.</p> <p>i The behaviour preset in this parameter will only be executed, if the output passes over to direct operation at the end of safety. Direct operation will be executed when a sun protection function is active.</p>
<p>☐ Ax – Sun protection (x = number of output pair 1/2 ... max. 15/16 In blinds operation / All outputs can be parameterized independent of one another. / Only visible in blinds operation and only accessible if parameter "Sun protection functions ?" under "Ax – Enabled functions" is set to "enabled"!)</p>	
<p>Priority of sun protection with respect to direct operation</p>	<p>This parameter defines the priority of the sun protection function with respect to direct operation.</p>
<p>same priority</p>	<p>The sun protection can be overridden by direct operation and vice versa. Only after the next reception of a "sun is shining" signal will the sun protection mode be activated again.</p>
<p>higher priority</p>	<p>The sun protection has the higher priority and cannot be aborted by a direct operation.</p>
<p>Lower priority</p>	<p>The direct operation has the higher priority and cannot be aborted by sun protection. The sun protection can be activated only after an enabling movement into the upper end position initiated by a direct operation has occurred without interruption.</p> <p>i Direct operation = long-time/short-time operation; Positioning via objects, scenes, central control.</p>
<p>Polarity of the "Sunshine / shading facade" object</p>	<p>sunshine = 1; no sunshine = 0</p> <p>This parameter defines the polarity of the input object</p>

<p>Sunshine = 0; no sunshine = 1</p> <p>☐ Ax – Beginning of sun protection (x = number of output pair 1/2 ... max. 15/16 In blinds operation / All outputs can be parameterized independent of one another. / Only visible in blinds operation and only accessible if parameter "Sun protection functions ?" under "Ax – Enabled functions" is set to "enabled"!) Time delay beginning of sunshine / shading Minutes (0...59)</p> <p>Seconds (0...59)</p> <p>Reaction at the beginning of sunshine / shading</p>	<p>0...59</p> <p>0...30...59</p>	<p>"Sunshine / shading facade" of the sun protection.</p> <p>The telegram received via the object "Sunshine / shading facade" for activation of shading (depending on polarity) can be evaluated with a time delay.</p> <p>Sets the delay time minutes.</p> <p>Sets the delay time seconds.</p> <p><i>Presetting: 30 seconds</i></p> <p>i A time setting of "0" in the parameters deactivates the respective delay time. In this case, the state of shading is evaluated immediately.</p> <p>This parameter defines the behaviour of the output at the beginning of shading – if applicable, after the end of the delay time.</p> <p>At the beginning of shading, the output switches over to sun protection while the relays of the output show no reaction. Any movements still in progress at this instant will still be finished.</p> <p>At the beginning of shading, the actuator raises the blind.</p> <p>At the beginning of shading, the actuator lowers the blind.</p> <p>At the beginning of shading, the actuator switches the relays of the output to the "stop" position. A drive movement, if any, will be interrupted.</p> <p>At the beginning of shading, an internal scene of the actuator is recalled.</p> <p>At the beginning of shading, the output controls the approach to a configured fixed Venetian blind and slat position.</p> <p>At the beginning of shading, the output controls the approach to a configured fixed Venetian blind position and to slat position preset by a separate object and thus variable.</p> <p>At the beginning of shading, the output controls the approach to a configured fixed slat position and to a Venetian</p>
<p>No reaction</p> <p>Raising</p> <p>Lowering</p> <p>stop</p> <p>Internal scene recall</p> <p>Venetian blind or slat position fixed</p> <p>Venetian blind position fixed / slat position variable</p> <p>Slat position fixed / Venetian blind position variable</p>		

		blind position preset by a separate object and thus variable.
	Venetian blind and slat position variable	At the beginning of shading, the output controls the approach to the Venetian blind and slat positions preset by two separate objects and thus variable.
Reaction at the beginning of sunshine / shading		<p>i This parameter is visible only in the "Venetian blind" operating mode.</p> <p>This parameter defines the behaviour of the output at the beginning of shading – if applicable, after the end of the delay time.</p>
	No reaction	At the beginning of shading, the output switches over to sun protection while the relays of the output show no reaction. Any movements still in progress at this instant will still be finished.
	Raising	At the beginning of shading, the actuator raises the blind.
	Lowering	At the beginning of shading, the actuator lowers the blind.
	stop	At the beginning of shading, the actuator switches the relays of the output to the "stop" position. A drive movement, if any, will be interrupted.
	Internal scene recall	At the beginning of shading, an internal scene of the actuator is recalled.
	shutter / awning position fixed	At the beginning of shading, the output controls the approach to a configured fixed roller shutter / awning position.
	Roller shutter / awning position variable	At the beginning of shading, the output controls the approach to the roller shutter / awning position preset by a separate object and thus variable.
Reaction at the beginning of sunshine / shading		<p>i This parameter is visible only in the "Roller Shutter / Awning" operating mode.</p> <p>This parameter defines the behaviour of the output at the beginning of shading – if applicable, after the end of the delay time.</p>
	No reaction	At the beginning of shading, the output switches over to sun protection while the relays of the output show no reaction. Any movements still in progress at this instant will still be finished.
	Opening the louvre	At the beginning of shading, the actuator opens the venting louvre.
	Closing the louvre	At the beginning of shading, the actuator closes the venting louvre.
	stop	At the beginning of shading, the actuator switches the relays of the output to the

		"stop" position. A drive movement, if any, will be interrupted.
	Internal scene recall	At the beginning of shading, an internal scene of the actuator is recalled.
	Fixed venting louvre position	At the beginning of shading, the output controls the approach to a configured fixed venting louvre position.
	Venting louvre position variable	At the beginning of shading, the output controls the approach to the venting louvre position preset by a separate object and thus variable.
		i This parameter is visible only in the "Venting louvre" operating mode.
Scene number (1...8)	1...8	This parameter defines the number of the internal scene which is recalled at the beginning of shading.
		i This parameter is only visible, if the parameter "Reaction at the beginning of sunshine / shading" is set to "internal scene recall".
Fixed Venetian blind position		The fixed Venetian blind position at the beginning of shading can either be preset statically by a separate parameter or basically adjusted to the value prevailing at the time of shading activation, i.e. remain unchanged.
	Same as configured value	At the beginning of shading, the configured Venetian blind position value will be approached.
	No change in current position	At the beginning of shading, the current position of the Venetian blind will be maintained. In this case, the output behaves as if only the slat were positioned as a result of shading.
		i This parameter is only visible, if the Venetian blind is to approach a fixed position at the beginning of shading.
		i This parameter is visible only in the "Venetian blind" operating mode.
Venetian blind position (0...100 %)	0... 50 ...100	This parameter sets the fixed position of the Venetian blind to be approached at the beginning of shading.
		i This parameter is only visible, if the parameter "Fixed position of Venetian blind" is set to "as specified by parameter".
		i This parameter is visible only in the "Venetian blind" operating mode.
Fixed slat position (0...100 %)	0... 50 ...100	This parameter sets the fixed position of the slat to be approached at the beginning of shading and, as the case may be, after positioning of the Venetian blind.

Fixed roller shutter / awning position	Same as configured value	<p>i This parameter is only visible, if the slat is to approach a fixed position at the beginning of shading.</p> <p>i This parameter is visible only in the "Venetian blind" operating mode.</p> <p>The fixed position of the roller shutter or awning at the beginning of shading can either be preset statically by a separate parameter or basically adjusted to the value prevailing at the time of shading activation, i.e. remain unchanged.</p>
	No change in current position	<p>At the beginning of shading, the configured roller shutter or awning position will be approached.</p> <p>At the beginning of shading, the current position of the roller shutter or awning will be maintained. Any movements in progress at the time of shading activation will be finished.</p>
Position of roller shutter / awning (0...100 %)	0... 50 ...100	<p>i This parameter is only visible, if the shutter or awning is to approach a fixed position at the beginning of shading.</p> <p>i This parameter is visible only in the "Roller Shutter / Awning" operating mode.</p> <p>This parameter sets the fixed position of the roller shutter or awning to be approached at the beginning of shading.</p> <p>i This parameter is only visible, if the parameter "Fixed position of shutter / awning" is set to "as specified by parameter".</p> <p>i This parameter is visible only in the "Roller Shutter / Awning" operating mode.</p>
Fixed position of venting louvre	Same as configured value	<p>The fixed venting louvre position at the beginning of shading can either be preset statically by a separate parameter or basically adjusted to the value prevailing at the time of shading activation, i.e. remain unchanged.</p> <p>At the beginning of shading, the configured venting louvre position will be approached.</p>
	No change in current position	<p>At the beginning of shading, the current position of the venting louvre will be maintained. Any movements in progress at the time of shading activation will be finished.</p> <p>i This parameter is only visible if the venting louvre is to approach a fixed position at the beginning of shading.</p>

<p>Position of venting louvre (0...100 %)</p>	<p>0...50...100</p>	<p>i This parameter is visible only in the "Venting louvre" mode of operation.</p> <p>This parameter sets the fixed position of the venting louvre to be approached at the beginning of shading.</p> <p>i This parameter is only visible, if the parameter "Fixed position of venting louvre" is set to "as specified by parameter".</p> <p>i This parameter is visible only in the "Venting louvre" operating mode.</p>
<p>Reference movement before each sun protection positioning operation ?</p>	<p>Yes No</p>	<p>A forced reference movement of the drive is performed before sun protection positioning (setting "yes"). A reference movement is a positioning movement into the upper end position or into the completely open position. By means of a forced reference movement, drives connected to different outputs can be synchronised. If no synchronising movement is forced (setting "no"), the actuator performs a reference movement only once after return of the power supply.</p>
<p>Offset with fixed and variable slat position</p>	<p>no offset Offset as configured Offset as configured and via object</p>	<p>For 'manual' readjustment of the slat angle during a shading, a slat offset can be preset. The offset corrects the preset slat angle in positive or in negative direction. The lighting conditions in a room can thus be individually adapted by persons present in the room.</p> <p>The offset correction is deactivated.</p> <p>The slat offset is statically preset by means of a fixed parameter value.</p> <p>The slat offset is preset by a fixed parameter value and can be dynamically adapted via a separate communication object.</p> <p>i This parameter is only visible, if the slat is to approach a fixed or a variable position at the beginning of shading.</p> <p>i This parameter is visible only in the "Venetian blind" operating mode.</p>
<p>Offset slat position (-100..100 %)</p>	<p>-100...0...100</p>	<p>This parameter is used for setting the slat offset. The value specified in this parameter is added at the beginning of shading to the current slat angle.</p> <p>i Even with offset correction, the 0...100% slat position limits cannot be overstepped.</p>

Store offset slat position via object in case of bus voltage failure ?"

Yes

- i** It should be noted that the configured offset value can be overwritten by the object after reception of a dynamic value.
- i** This parameter is only visible, if the parameter "Offset with fixed and variable slat position" is set to "Offset as configured" or to "Offset as configured and via object".
- i** This parameter is visible only in the 'Venetian blind' operating mode.

If the offset is preset via the object, this parameter defines whether the received value is to be stored in the actuator's NV memory.

The value received via the object will be stored in case of bus or mains voltage failure in a non-volatile memory of the actuator. The originally configured offset value is definitely overwritten in the process.

No

The value received via the object will only be stored temporarily in volatile memory. This only replaces the configured value until the actuator is reinitialised (bus or mains voltage return, if both were previously switched off). After the initialisation, the offset value configured will be used again.

- i** This parameter is only visible, if the parameter "Offset with fixed and variable slat position" is set to "offset as configured and via object".
- i** This parameter is visible only in the 'Venetian blind' operating mode.

☐ Ax – End of sun protection (x = number of output pair 1/2 ... max. 15/16 In blinds operation / All outputs can be parameterized independent of one another. / Only visible in blinds operation and only accessible if parameter "Sun protection functions ?" under "Ax – Enabled functions" is set to "enabled"!)

Time delay end of sunshine / shading Minutes (0...59)

0...59

The telegram received via the object "Sunshine / shading facade" for deactivation of shading (depending on polarity) can be evaluated with a time delay.

Sets the delay time minutes.

Seconds (0...59)

0...**30**...59

Sets the delay time seconds.

Presetting: 30 seconds

		<p>i A time setting of "0" in the parameters deactivates the respective delay time. In this case, the state of shading is evaluated immediately.</p>
Reaction at the end of sunshine / shading		This parameter defines the behaviour of the output at the end of shading – if applicable, after the end of the delay time.
	No reaction	At the end of shading, the output quits the sun protection mode and the relays of the output show no reaction. Any movements still in progress at this instant will still be finished.
	Raising / opening the louvre	At the end of shading, the actuator raises the curtain or opens the venting louver.
	Lowering / closing the louvre	At the end of shading, the actuator lowers the curtain or closes the venting louver.
	stop	At the end of shading, the actuator switches the relays of the output to the "stop" position. A drive movement, if any, will be interrupted.
	Tracking the position	At the end of shading, the output will be set to the state last adjusted before sun protection or to the state tracked and internally stored during sun protection. The position objects, the long time object and the scene function are tracked.
		<p>i The behaviour preset in this parameter will only be executed if no function with a higher priority (e. g. safety) is activated at the end of shading.</p>
<p>☐ Ax – Scenes (x = number of output pair 1/2 ...max. 15/16 in blinds operation / All outputs can be parameterized independently. / Only visible in blinds operation and only accessible if parameter "Scene function" under "Ax - Enabled functions" is set to "enabled"! / for actuator 8/16 gang only available with ETS3.0d and higher)</p>		
Delay scene recall ?	Yes	A scene is recalled via the scene extension object. If needed, the scene recall on the actuator can be made with a delay after reception of a recall telegram (setting: "Yes"). The recall is alternatively made immediately on reception of the telegram (setting: "No").
	No	
		<p>i A recall delay has no influence on the storage of scene values.</p>
Delay time Minutes (0...59)	0...59	This parameter is used for setting the duration of the scene delay.

<p>Seconds (0...59)</p>	<p>0...10...59</p>	<p>Sets the scene delay in minutes.</p> <p>Sets the scene delay in seconds.</p> <p><i>Presetting: 10 seconds</i></p> <p>i The delay time parameters are only visible, if the parameter "Delay scene recall ?" is configured to "Yes".</p>
<p>Overwrite values stored in the device during ETS download ?</p>	<p>Yes</p> <p>No</p>	<p>During storage of a scene, the scene values (current states of the outputs concerned) are stored internally in the device. To prevent the stored values from being replaced during an ETS programming operation by the originally programmed scene states, the actuator can inhibit overwriting of the scene values (setting: "No"). As an alternative, the original values can be reloaded into the device during each ETS programming operation (setting: "Yes").</p>
<p>Scene X activatable by scene number (scene number "0" = scene deactivated)</p> <p><i>X = depending on the scene (1...8)</i></p>	<p>0...1*...64</p> <p><i>*: The predefined scene number is dependent on the scene (1...8).</i></p>	<p>The actuator distinguishes between up to 8 different scenes which are recalled via the scene extension object or stored. The datapoint type of the extension object, however, permits addressing a maximum of 64 scenes. This parameter defines the scene number (1...64) which is used to address the internal scene (1...8). A setting of "0" deactivates the corresponding scene.</p>
<p>Venetian blind position for scene X</p> <p><i>X = depending on the scene (1...8)</i></p>	<p>0*...100</p> <p><i>*: The predefined position value is dependent on the scene (1...8).</i></p>	<p>This parameter is used for parameterising the blind position which is executed when the scene is recalled.</p> <p>i This parameter is visible only in the 'Venetian blind' operating mode.</p>
<p>Slat position for scene X</p> <p><i>X = depending on the scene (1...8)</i></p>	<p>0*...100</p> <p><i>*: The predefined position value is dependent on the scene (1...8).</i></p>	<p>This parameter is used for configuring the slat position which is executed when the scene is recalled.</p> <p>i This parameter is visible only in the 'Venetian blind' operating mode.</p>
<p>Roller shutter/awning position for scene X</p> <p><i>X = depending on the scene (1...8)</i></p>	<p>0*...100</p> <p><i>*: The predefined position value is dependent on the scene (1...8).</i></p>	<p>This parameter is used for configuring the roller shutter or awning position which is executed when the scene is recalled.</p>

		<p>i This parameter is visible only in the "Roller Shutter / Awning" operating mode.</p>
<p>Position of venting louver for scene X</p> <p>X = depending on the scene (1...8)</p>	<p>0*...100</p> <p><i>*: The predefined position value is dependent on the scene (1...8).</i></p>	<p>This parameter is used for configuring the louver position which is executed when the scene is recalled.</p> <p>i This parameter is visible only in the "Venting louvre" operating mode.</p>
<p>Storage function for scene X</p> <p>X = depending on the scene (1...8)</p>	<p>Yes</p> <p>No</p>	<p>Setting "yes" enables the storage function of the scene. If the function is enabled, the current position (0...100 %) can be stored internally via the extension object on reception of a storage telegram. If "no" is selected, the storage telegrams are rejected.</p>
<p><input type="checkbox"/> Ax – Forced position (x = number of output pair 1/2 ... max. 15/16 In blinds operation / All outputs can be parameterized independent of one another. / Only visible in blinds operation and only accessible if parameter "Forced position function" under "Ax - Enabled functions" is set to "enabled"! / for actuator 8/16 gang only available with ETS3.0d and higher)</p>		
<p>Behaviour at the end of the forced position function</p>	<p>position tracking</p>	<p>The behaviour of the output at the beginning of a forced position function is directly determined by the forced position telegram. The behaviour of the output at the end of the forced position function can be parameterized.</p> <p>At the end of the forced position state, the output will be set to the position last existing before the forced position function or to the one tracked internally while the forced position function was active.</p>
	<p>no change</p>	<p>At the end of forced position state, the position last adjusted will not be changed. Thereafter, the output is again enabled.</p>
<p>Behaviour after bus voltage return</p>	<p>no forced position active</p>	<p>The communication object of the forced position function can be initialised after <u>bus</u> voltage return.</p> <p>After bus voltage return, the forced position function is deactivated.</p>
	<p>forced position on, raising / opening the louver</p>	<p>The forced position function is activated after bus voltage return and the curtain is raised or the venting louver opened.</p>
	<p>forced position on, lowering / closing the louver</p>	<p>The forced position function is activated after bus voltage return and the curtain lowered or the venting louver closed.</p>
	<p>state of forced position before bus/mains failure</p>	<p>After bus voltage return, the forced position state last selected and internally stored <u>before</u> bus or mains voltage</p>

failure will be tracked. An ETS programming operation deletes the stored state (reaction in that case same as with "no forced position active").

- i** This parameter is evaluated even after ETS programming of the application or of the parameters.
- i** The forced position parameters are only visible if the parameter "Forced position function" under "Ax Enabled functions" is set to "enabled".

Ax – Fabric-stretching (x = number of output pair 1/2 ... max. 15/16 In blinds operation / All outputs can be parameterized independent of one another. / Only visible for "Roller shutter/awning" and only accessible if parameter "Fabric-stretching function" under "Ax - Enabled functions" is set to "enabled"!

Time for fabric stretching
Seconds (0...59)

0...1...59

This parameter is used for setting the duration of the fabric-stretching.

Sets the seconds of the fabric-stretching.

Milliseconds
(0...9 x 100)

0...9

Sets the milliseconds of the fabric-stretching.

Presetting: 1 second

- i** The time for fabric stretching must be set less than the movement time of the roller shutter/awning.

Ax – General (x = number of output A1 ... max. A16 in switching operation / All outputs can be parameterized independent of one another. / Only visible in switching operation!)

Mode of operation

The relays of a switching output can be parameterized as NO or NC contacts. This feature makes it possible to invert the switching states.

NO contact

Switching state = off ("0") ->
Relay contact open
Switching state = on ("1") ->
Relay contact closed

NC contact

Switching state = off ("0") ->
Relay contact closed
Switching state = on ("1") ->
Relay contact open

Behaviour after ETS programming

The actuator permits setting the preferred relay contact position after ETS programming separately for each output.

close contact

The relay contact closes after an ETS programming operation

open contact

		The relay contact opens after an ETS programming operation
	No reaction	<p>After ETS programming, the relay of the output shows no response and remains in the switching state currently selected.</p> <p>i The configured behaviour will be executed after every application or parameter download by the ETS. A simple download of the physical address alone or partial programming of only the group addresses has the effect that this parameter is disregarded and that the configured "Behaviour after bus voltage return" will be executed instead.</p>
Behaviour in case of bus voltage failure		The actuator permits setting the preferred relay contact position in case of bus voltage failure separately for each output.
	close contact	The relay contact closes in case of bus voltage failure.
	open contact	The relay contact opens in case of bus voltage failure.
	No reaction	In case of bus voltage failure, the relay of the output shows no reaction and remains in the switching state currently selected.
Behaviour after bus or mains voltage return		The actuator permits setting the preferred relay contact position after bus or mains voltage return separately for each output.
	close contact	The relay contact closes after bus or mains voltage return.
	open contact	The relay contact opens after bus or mains voltage return.
	state as before bus/mains voltage failure	After bus or mains voltage return, the switching state last existing and internally stored <u>before</u> bus or mains voltage failure will be tracked.
	Activate staircase function (if parameterized)	The staircase function is – irrespective of the 'Switching' object - activated after bus or mains voltage return. With this setting it should be noted that the staircase function is also enabled and meaningfully programmed. When the staircase function is not enabled, there is no reaction after bus or mains voltage return with this setting.

- i** Setting "State as before bus/mains voltage failure": An ETS programming operation of the application or the parameter resets the internally stored switching state to "off - 0".
- i** The device adopts the parameterized behaviour only if the last ETS programming of the application or of the parameters ended at least ca. 20 s ago. Otherwise ($T_{ETS} < 20$ s), the "Behaviour after ETS programming" will be adopted also in case of bus voltage return.
- i** It should be noted that a forced position can also be activated after bus/mains voltage return, which might possibly affect the switching state of the output.

Assignment to central function ?

This parameter determines the assignment of the output to the central function.

Yes (enable central function under "General"!)

The output is assigned to the central function. The central switching function is supposed to have been enabled under "General". The assignment has otherwise no effect on the switching output.

No

The output is not assigned to the central function.

Feedback ?

The current switching state of the output can be reported separately back to the bus.

none

No feedback object available for the output. Feedback deactivated.

no inversion, active signalling object

Feedback and the object are activated. The state is transmitted non-inverted. The object transmits actively (telegram transmission after change).

no inversion, passive status object

Feedback and the object are activated. The state is transmitted non-inverted. The object is passive (telegram transmission only as a response to 'Read' request).

inversion, active signalling object

Feedback and the object are activated. The state is transmitted inverted. The object transmits actively (telegram transmission after change).

inversion, passive status object

Feedback and the object are activated. The state is transmitted inverted. The

		object is passive (telegram transmission only as a response to 'Read' request).
		i The communication flags of the object are automatically set by the ETS according to the setting.
Time delay for feedback after bus voltage return ?	Yes (delay time under "General") No	The feedback telegram can be transmitted to the bus with a delay after bus voltage return or after programming with the ETS. Setting "Yes" activates the delay time of the feedback in case of bus voltage return. The delay time is parameterized under "General".
Cyclical transmission of the feedback ?	Yes (transmission cyclically and when change) No (transmission only when change)	The object value of the feedback can be transmitted cyclically. The feedback telegram is transmitted to the bus cyclically and when there is a change of state. The cycle time is parameterised under "Times" generally for all feedback telegrams. The feedback telegram is transmitted to the bus only when there is a change of state.
<input type="checkbox"/> Ax – Enabling functions (x = number of output A1 ... max. A16 in switching operation / All outputs can be parameterized independent of one another. / Only visible in switching operation!)		
Time delays	disabled Enabled	This parameter can be used to disable or to enable the time delays. When the function is enabled, the required parameters will be displayed under "Ax – Time delays".
Staircase function	disabled Enabled	This parameter can be used to disable or to enable the staircase function. When the function is enabled, the corresponding parameters will be displayed under "Ax Staircase function" and the necessary objects enabled.
Light scene function (For actuator 8/16 gang only available with ETS3.0d and higher)	disabled Enabled	This parameter can be used disable or to enable the scene function. When the function is enabled, the corresponding parameters will be displayed under "Ax Scenes" and the necessary object enabled.
<input type="checkbox"/> Ax – Time delays (x = number of output A1 ... max. A16 in switching operation / All outputs can be parameterized independent of one another. / Only visible in switching operation and only accessible if parameter "Time delays ?" under "Ax – Enabled functions" is set to "enabled!")		

<p>Selection of time delay</p> <p>Switch-off delay</p> <p>Switch-on delay</p> <p>Switch-on and switch-off delay</p>	<p>no time delay</p>	<p>The communication object "Switching" can be evaluated with a time delay. This parameter selects the desired mode of operation of the time delay and enables the other delay parameters.</p>
<p>Switch-on delay Hours (0...23)</p>	<p>0...23</p>	<p>This parameter is used for programming the duration of the switch-on delay</p> <p>Sets the switch-on delay hours.</p>
<p>Minutes (0...59)</p>	<p>0...59</p>	<p>Sets the switch-on delay minutes.</p>
<p>Seconds (0...59)</p>	<p>0...30...59</p>	<p>Sets the switch-on delay seconds.</p> <p><i>Presetting: 30 seconds</i></p>
<p>Switch-on delay retriggerable ?</p>	<p>Yes</p> <p>No</p>	<p>An active switch-on delay can be retriggered by another "1" telegram (setting "Yes"). Alternatively, retriggering can be suppressed (setting "No").</p> <p>i The switch-on delay parameters are only visible if the parameter "Selection of time delay" is set to "Switch-on delay" or to "Switch-on and switch-off delay".</p>
<p>Switch-off delay Hours (0...23)</p>	<p>0...23</p>	<p>This parameter is used for programming the duration of the switch-off delay</p> <p>Sets the switch-off delay hours.</p>
<p>Minutes (0...59)</p>	<p>0...59</p>	<p>Sets the switch-off delay minutes.</p>
<p>Seconds (0...59)</p>	<p>0...30...59</p>	<p>Sets the switch-off delay seconds.</p> <p><i>Presetting: 30 seconds</i></p>
<p>Switch-off delay retriggerable ?</p>	<p>Yes</p> <p>No</p>	<p>An active switch-off delay can be retriggered by another "0" telegram (setting "Yes"). Alternatively, retriggering can be suppressed (setting "No").</p> <p>i The switch-off delay parameters are only visible if the parameter "Selection of time delay" is set to "Switch-off delay" or to "Switch-on and switch-off delay".</p>

Ax – Staircase function (x = number of output A1 ... max. A16 in switching operation / All outputs can be parameterized independent of one another. / Only visible in switching operation

and only accessible if parameter "Staircase function ?" under "Ax – Enabled functions" is set to "enabled"!)

Staircase time Hours (0...23)	0...23	This parameter is used for programming the duration of the staircase time.
		Sets the staircase time in hours.
Minutes (0...59)	0...3...59	Sets the staircase time in minutes.
Seconds (0...59)	0...59	Sets the staircase time in minutes.
		<i>Presetting: 3 minutes</i>
Staircase time retriggerable ?	Yes No	An active staircase time can be retriggered (setting "Yes"). Alternatively, the retriggering time can be suppressed (setting "No").
Reaction to OFF- telegram	switch off ignore	An active staircase time can be aborted prematurely by switching off the staircase function. The staircase time is aborted by receipt of an OFF telegram to the object "Staircase time start/stop". OFF Telegrams are ignored. The staircase time will be executed completely to the end.
Activate the switch-on delay for the staircase function ?	Yes No	The staircase function enables the activation of an own switch-on delay. This switch-on delay affects the trigger result of the staircase function and thus delays the switch-on. The switch-on delay is activated. The switch-on delay is deactivated. i The switch-on delay configured here is to be understood independent of the other time functions of the actuator. It only affects the staircase function and not the "switching" object.
Switch-on delay Hours (0...23)	0...23	This parameter is used for setting the duration of the switch-on delay.
		Sets the switch-on delay hours.
Minutes (0...59)	0...59	Sets the switch-on delay minutes.
Seconds (0...59)	0...30...59	Sets the switch-on delay seconds.
		<i>Presetting: 30 seconds</i>

Switch-on delay retriggerable ?	<p>Yes</p> <p>No</p>	<p>An active switch-on delay can be retriggered (setting "Yes"). Alternatively, the retriggering time can be suppressed (setting "No").</p> <p>i The parameters for the switch-on delay are only visible when the parameter "Activate switch-on delay for the staircase function ?" is configured to "Yes".</p>
Activate pre-warning time ?	<p>Yes</p> <p>No</p>	<p>After the staircase time of a staircase function has elapsed, the output can generate pre-warnings before switching off. The pre-warnings should warn any person still on the staircase that the light will soon be switched off.</p> <p>The pre-warning function is activated.</p> <p>The pre-warning function is deactivated.</p>
Pre-warning time Minutes (0...59)	0...59	<p>This parameter is used for setting the duration of the pre-warning time. The pre-warning time is added to the staircase time. Pre-warnings (switch off output) are only generated within the pre-warning time.</p>
Seconds (0...59)	0...30...59	<p>Sets the pre-warning time in minutes.</p> <p>Sets the pre-warning time in seconds.</p> <p><i>Presetting: 30 seconds</i></p> <p>i A pre-warning time still in progress is aborted by re-triggering the staircase function.</p>
Number of pre-warnings (1...10)	1...3...10	<p>This parameter defines how often the output is to switch off within the pre-warning time. i.e. how many pre-warnings will be generated.</p>
Time for pre-warning interruptions Seconds (0...59)	0...59	<p>This parameter defines the duration of a pre-warning interruption, i.e. how long the output is to remain off during a pre-warning interruption. The time should be customized individually to the switch-off behaviour of the lamp used.</p> <p>Sets the pre-warning interruption seconds.</p>
	0...5...9	

		ETS programming operation (setting: "Yes").
Scene X activatable by scene number (scene number "0" = scene deactivated) X = depending on the scene (1...8)	0...1*...64 *: The predefined scene number is dependent on the scene (1...8).	The actuator distinguishes between up to 8 different scenes which are recalled via the scene extension object or stored. The datapoint type of the extension object, however, permits addressing a maximum of 64 scenes. This parameter defines the scene number (1...64) which is used to address the internal scene (1...8). A setting of "0" deactivates the corresponding scene.
Switching state for scene X X = depending on the scene (1...8)	switch on switch off	This parameter is used for configuring the switching command which is executed when the scene is recalled.
Storage function for scene X X = depending on the scene (1...8)	Yes No	Setting "yes" enables the storage function of the scene. If the function is enabled, the current switching position (switched on / switched off) can be stored internally via the extension object on reception of a storage telegram. If "no" is selected, the storage telegrams are rejected.
<p>☐ Ax – supplementary functions (x = number of output A1 ... max. A16 in switching operation / All outputs can be parameterized independent of one another. / Only visible in switching operation!)</p>		
Selection of supplementary function	no supplementary function Disabling function Forced position	The supplementary function can be defined and enabled here. The disabling function is only configurable as an alternative to the forced position function.
Polarity of the disabling object	0 = disabled; 1 = enabled; 1 = enabled; 0 = disabled	This parameter defines the polarity of the disabling object. i After a bus or mains voltage return or programming the application or parameters with the ETS, the disabling function is always deactivated (object value "0"). With the inverted setting ("1 = enabled; 0 = disabled"), a telegram update "0" must first be carried out after the initialisation until the disabling is activated.

i This parameter is visible only if the disabling function is enabled.

Behaviour at the beginning of the disabling function

no change of switching state

The behaviour of the output at the beginning of the disabling function can be configured.

At the beginning of the disabling function, the relay of the output shows no reaction and remains in the current switching state. Thereafter, the output is again locked.

switch off

The output switches off at the beginning of the disabling function and locks itself.

switch on

The output switches on at the beginning of the disabling function and locks itself.

Flashing

The output flashes on and off during the disabling function and is locked during this time. The flashing time is configured generally for all outputs under "General". During the flashing, the logical switching state is "on -1".

i An output disabled via the bus can be still be operated manually!

i This parameter is visible only if the disabling function is enabled.

Behaviour at the end of the disabling function

no change of switching state

The behaviour of the output at the end of the disabling function can be configured.

The internal switching state is not changed at the end of the disabling function. Thereafter, the output is again enabled.

switch off

The switching state is set to switch off at the end of the disabling function. The output is enabled again.

switch on

The switching state is set to switch on at the end of the disabling function. The output is enabled again.

setting tracked state

At the end of the disabling function, the last switching state existing before the disabling function or the switching state internally tracked during the disabling function will be set. Any time functions or staircase functions that are still in progress will also be taken into account if necessary.

Flashing

At the end of the disabling function, the output will flash on and off and be enabled again. The flashing continues until a new switching state is specified. The flashing time is configured generally

<p>Behaviour at the end of the forced position function</p>		<p>for all outputs under "General". During the flashing, the logical switching state is "on 1".</p> <ul style="list-style-type: none"> i The states set at the end of the disabling function do not start any time functions (Exception: "set tracked state"). i If a logic operation is configured, the state will be evaluated in the logic operation function as if the state had been updated via the "Switching" object (no evaluations of time functions). i This parameter is visible only if the disabling function is enabled.
	<p>tracking the switching state</p>	<p>The behaviour of the output at the beginning of a forced position function is directly determined by the forced position telegram. The behaviour of the output at the end of the forced position function can be configured.</p>
	<p>no change of switching state</p>	<p>At the end of the forced position, the last switching state existing before the forced function or the switching state internally tracked during the forced function will be set. Any time functions or staircase functions that are still in progress will also be taken into account if necessary.</p>
	<p>switch off</p>	<p>The internal switching state is not changed at the end of the forced position. Thereafter, the output is again enabled.</p>
	<p>switch on</p>	<p>The switching state is set to switch off at the end of the forced position. The output is enabled again.</p>
	<p>switch on</p>	<p>The switching state is set to switch on at the end of the forced position. The output is enabled again.</p> <ul style="list-style-type: none"> i The states set at the end of the forced position do not start any time functions (Exception: "set switching state"). i If a logic operation is configured, the state will be evaluated in the logic operation function as if the state had been updated via the "Switching" object (no evaluations of time functions).
<p>Response to bus voltage return</p>		<p>The forced position communication object can be initialised after bus voltage return. The switching state of the output</p>

		can be influenced when the forced position function is being activated.
	No forced position	No forced position is activated after bus voltage return. Reaction of the output according to the parameter "Behaviour after bus or mains voltage return".
	forced position on, switch on	The forced position is activated. The output is switched on under forced control.
	forced position on, switch off	The forced position is activated. The output is evaluated under forced control.
	State of forced position before bus/mains voltage failure	The state of the forced position is set in such a way as it was stored non-volatile at the time of the bus or mains failure. After programming the application or parameters with the ETS, the value is set internally to "not active".
		<p>i After programming of the application or of the parameters with the ETS, the forced position is always cancelled.</p> <p>i This parameter is only visible when the forced position function is enabled.</p>
Logic operation function ?	Yes	This parameter can be used to enable the logic operation function (setting "Yes").
	No	
		<p>i The logic operation function can only be enabled when no staircase function is enabled.</p>
Type of logic operation function	OR	This parameter defines the logical type of the logic operation function. The object "logic operation" is linked to the logic switching state of the output (object "switching" after evaluation of the configured time delays if necessary) using the logic operation function set here.
	AND	
	AND with feedback	
		<p>i This parameter is only visible when the logic operation function is enabled.</p>
Object value of logic operation object after bus voltage return	0 (OFF)	After bus voltage return, the object value of the logic operation object is initialised here with the preset value.
	1 (ON)	
		<p>i This parameter is only visible when the logic operation function is enabled.</p>

5 Appendix

5.1 Index

B		
Blind mode of operation.....	62	
bus or mains voltage return.....	62	
bus voltage failure.....	62	
C		
Calculating the slat position.....	69, 71	
change-over time.....	68	
Channel definition.....	43	
Commissioning with the ETS.....	12	
Connection.....	8	
D		
Delay after bus voltage return.....	33	
Determining and configuring long-time ..	66	
operation		
Determining and configuring short- ..	66	
time operation		
Determining and configuring travelling ..	66	
time		
Drive movement feedback.....	78	
E		
ETS configuration.....	25	
ETS search paths.....	21	
F		
Fabric-stretching.....	102	
Fitting the device.....	7	
G		
Global safety functions.....	40	
L		
Light scene function.....	96	
M		
Manual operation.....	36	
Measuring the slat moving time.....	12	
Measuring the travelling time ..	11	
extension		
Measuring the travelling times.....	11	
P		
Performing a reference run.....	12	
Position feedback.....	75	
Presetting the mode of operation.....	62	
Presetting the position.....	74	
Presetting the STEP operation.....	66	
programming with the ETS.....	62	
R		
Reference movement.....	73	
S		
Safe-state mode.....	25	
Safety function.....	80	
Scene function switching outputs.....	54, 56	
Slat travelling time.....	67	
Staircase function.....	50	
state as delivered.....	104	
Sun protection application examples.....	93	
Sun protection function.....	83	
Switching mode of operation.....	44	
Switching status feedback.....	47	
T		
Time delays switching outputs.....	49	
travelling time extension.....	68	

ALBRECHT JUNG GMBH & CO. KG
Volmestraße 1
58579 Schalksmühle

Telefon: +49.23 55.8 06-0
Telefax: +49.23 55.8 06-2 04
kundencenter@jung.de
www.jung.de

Service Center
Kupferstr. 17-19
44532 Lünen
Germany